



FULL MANUAL

HF/50 MHz TRANSCEIVER

IC-7300

INTRODUCTION

1 PANEL DESCRIPTION

2 INSTALLATION AND CONNECTIONS

3 BASIC OPERATION

4 RECEIVING AND TRANSMITTING

5 SCOPE OPERATION

6 VOICE RECORDER FUNCTIONS

7 VOICE TX MEMORY OPERATION

8 USING AN SD CARD

9 MEMORY OPERATION

10 SCANS

11 ANTENNA TUNER OPERATION

12 SET MODE

13 OTHER FUNCTIONS

14 MAINTENANCE

15 UPDATING THE FIRMWARE

16 SPECIFICATIONS

17 OPTIONS

18 CONNECTOR INFORMATION

19 CONTROL COMMAND

INDEX

ABOUT CE

Thank you for choosing this Icom product. The IC-7300 HF/50 MHz TRANSCEIVER is designed and built with Icom's state of the art technology and craftsmanship. With proper care, this product should provide you with years of trouble-free operation. We appreciate you making the IC-7300 your transceiver of choice, and hope you agree with Icom's philosophy of "technology first." Many hours of research and development went into the design of your IC-7300.

IMPORTANT

READ ALL INSTRUCTIONS carefully completely before using the transceiver.

SAVE THIS INSTRUCTION MANUAL— This instruction manual contains full operating instructions for the IC-7300.

FEATURES

- **RF Direct Sampling System**

The IC-7300 employs an RF direct sampling system. RF signals are directly converted to digital data and processed in the FPGA. This system is a leading technology marking an epoch in amateur radio.

- **Real-Time Spectrum Scope**

The spectrum scope is class-leading in resolution, sweep speed and dynamic range. When you touch the scope screen on the intended signal, the touched area is magnified. The large 4.3 inch color TFT touch LCD offers intuitive operation.

- **New "IP+" Function**

The new IP Plus function improves 3rd order intercept point (IP3) performance. When a weak signal is received adjacent to strong interference, the AD converter is optimized against signal distortion.

- **Class Leading RMDR and Phase Noise Characteristics**

The RMDR is improved to about 97dB (typical value) and Phase Noise characteristics are also improved about 15dB (at 1 kHz frequency separation) compared to the IC-7200.

- **A 4.3 inch touch screen color display**
- **A built-in automatic antenna tuner**
- **Multi-function control for easy settings**

EXPLICIT DEFINITIONS

WORD	DEFINITION
⚠ DANGER!	Personal death, serious injury or an explosion may occur.
⚠ WARNING!	Personal injury, fire hazard or electric shock may occur.
CAUTION	Equipment damage may occur.
NOTE	Recommended for optimum use. No risk of personal injury, fire or electric shock.

SUPPLIED ACCESSORIES

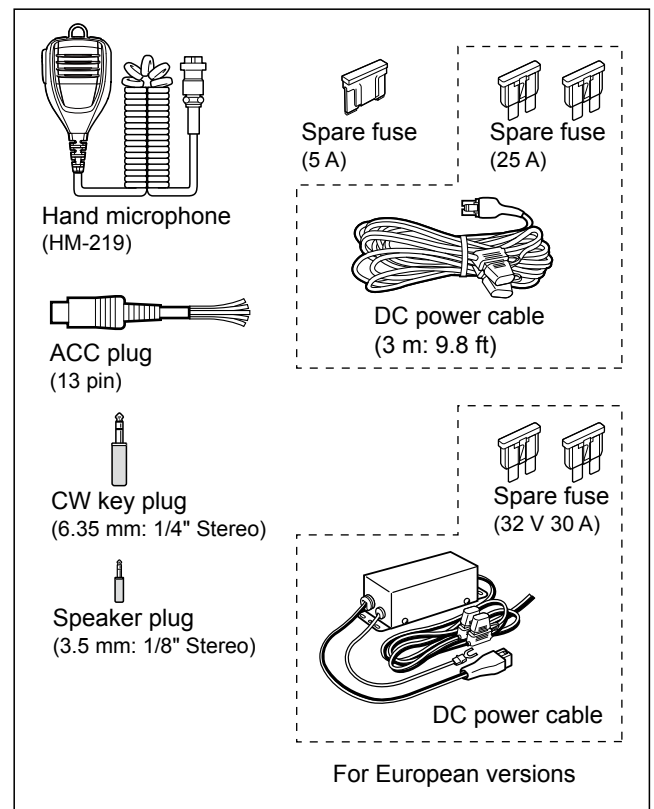

① Different types of accessories may be supplied, or may not be supplied depending on the transceiver version.

Icom does not guarantee the performance of the PC, network device, or network settings.

This product includes RTOS "RTX" software, and is licensed according to the software license.

This product includes "zlib" open source software, and is licensed according to the open source software license.

This product includes "libpng" open source software, and is licensed according to the open source software license.

Refer to the "About the Licenses" page at the end of the Basic manual for information on the open source software being used in this product.

FCC INFORMATION

This equipment has been tested and found to comply with the limits for a Class B digital device, pursuant to part 15 of the FCC Rules. These limits are designed to provide reasonable protection against harmful interference in a residential installation. This equipment generates, uses and can radiate radio frequency energy and, if not installed and used in accordance with the instructions, may cause harmful interference to radio communications. However, there is no guarantee that interference will not occur in a particular installation. If this equipment does cause harmful interference to radio or television reception, which can be determined by turning the equipment off and on, the user is encouraged to try to correct the interference by one or more of the following measures:

- Reorient or relocate the receiving antenna.
- Increase the separation between the equipment and receiver.
- Connect the equipment into an outlet on a circuit different from that to which the receiver is connected.
- Consult the dealer or an experienced radio/TV technician for help.

WARNING: MODIFICATION OF THIS DEVICE TO RECEIVE CELLULAR RADIOTELEPHONE SERVICE SIGNALS IS PROHIBITED UNDER FCC RULES AND FEDERAL LAW.

CAUTION: Changes or modifications to this device, not expressly approved by Icom Inc., could void your authority to operate this device under FCC regulations.

DISPOSAL



The crossed-out wheeled-bin symbol on your product, literature, or packaging reminds you that in the European Union, all electrical and electronic products, batteries, and accumulators (rechargeable batteries) must be taken to designated collection locations at the end of their working life. Do not dispose of these products as unsorted municipal waste. Dispose of them according to the laws in your area.

ABOUT CE AND DOC

CE Hereby, Icom Inc. declares that the versions of IC-7300 which have the “CE” symbol on the product, comply with the essential requirements of the Radio Equipment Directive, 2014/53/EU, and the restriction of the use of certain hazardous substances in electrical and electronic equipment Directive, 2011/65/EU.

The full text of the EU declaration of conformity is available at the following internet address:
<https://www.icomjapan.com/support/>

TRADEMARKS

Icom and the Icom logo are registered trademarks of Icom Incorporated (Japan) in Japan, the United States, the United Kingdom, Germany, France, Spain, Russia, Australia, New Zealand and/or other countries.

Microsoft and Windows are trademarks of the Microsoft group of companies.

Adobe, Acrobat, and Reader are either registered trademarks or trademarks of Adobe Systems Incorporated in the United States and/or other countries.

All other products or brands are registered trademarks or trademarks of their respective holders.

Icom is not responsible for the destruction, damage to, or performance of any Icom or non-Icom equipment, if the malfunction is because of:

- Force majeure, including, but not limited to, fires, earthquakes, storms, floods, lightning, or other natural disasters, disturbances, riots, war, or radioactive contamination.
- The use of Icom transceivers with any equipment that is not manufactured or approved by Icom.

ABOUT THE TOUCH SCREEN

◇ Touch operation

In the Full manual or Basic manual, the touch operation is described as shown below.



Touch

If the display is touched briefly, one short beep sounds.



Touch for 1 second

If the display is touched for 1 second, one short and one long beep sound.

◇ Touch screen precautions

- The touch screen may not properly work when the LCD protection film or sheet is attached.
- Touching the screen with your finger nails, sharp topped object and so on, or touching the screen hard may damage it.
- Tablet PC's operations such as flick, pinch in and pinch out cannot be performed on this touch screen.

◇ Touch screen maintenance

- If the touch screen becomes dusty or dirty, wipe it clean with a soft, dry cloth.
- When you wipe the touch screen, be careful not to push it too hard or scratch it with your finger nails. Otherwise you may damage the screen.

ABOUT THE MANUALS

The following manuals are published at the following internet address:

<https://www.icomjapan.com/support/>

Enter "IC-7300" into the Search box in the site.

• **Basic manual (English)**

Instructions for basic operations.

• **Full manual (This manual)**

Instructions for full operations in English.

• **Basic manual (Multi-language)**

Instructions for basic operations in multiple languages.

For reference

• **HAM radio Terms (English)**

A glossary of HAM radio terms in English.

To read the manuals, Adobe® Acrobat® Reader® is required. If you have not installed it, please download the Adobe® Acrobat® Reader® and install it to your PC. You can download it from Adobe Systems Incorporated's website.

Functions and features of Adobe® Acrobat® Reader®

The following functions and features can be used with Adobe® Acrobat® Reader®.

• Keyword search

Click “Find (Ctrl+F)” or “Advanced Search (Shift+Ctrl+F)” in the Edit menu to open the search screen. This is convenient when searching for a particular word or phrase in this manual. *The menu screen may differ, depending on the Adobe® Acrobat® Reader® version.

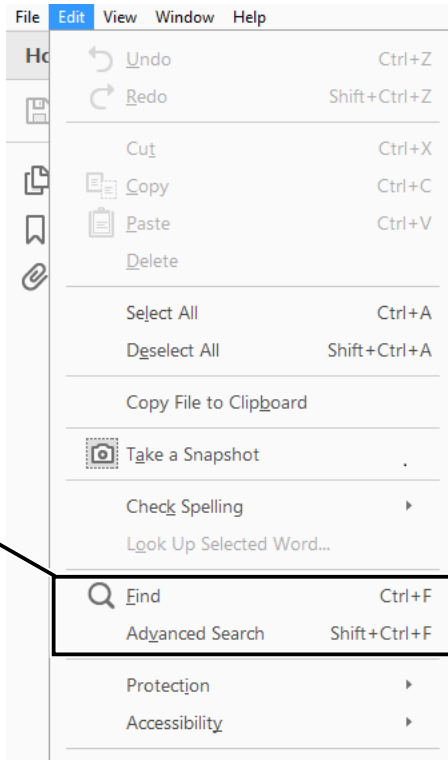

Click to open the find or search screen or advanced search screen.

• Find screen

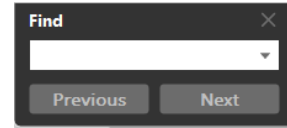

• Advanced search screen

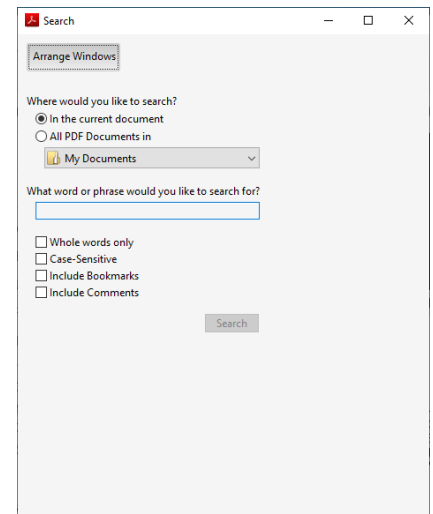

• Printing out the desired pages.

Click “Print” in File menu, and then select the paper size and page numbers you want to print. *The printing setup may differ, depending on the printer. Refer to your printer’s instruction manual for details. *Select “A4” size to print out the page in the equalized size.

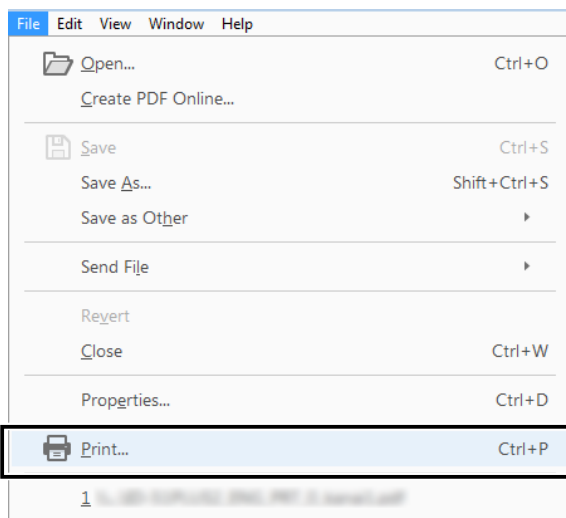

• Read Out Loud feature.

The Read Out Loud feature reads aloud the text in this Instruction Manual. Refer to the Adobe® Acrobat® Reader® Help for the details. (This feature may not be usable, depending on your PC environment including the operating system.)

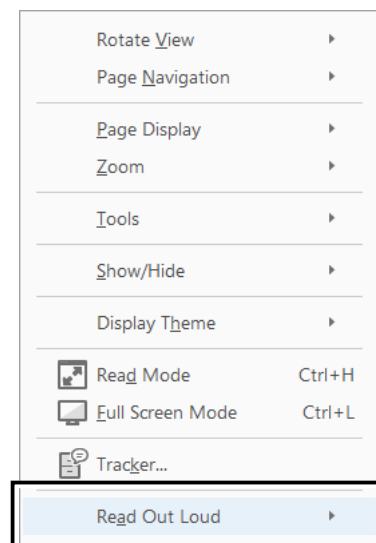

*The screen may differ, depending on the Adobe® Acrobat® Reader® version.

ABOUT THE INSTRUCTIONS

The Full and Basic manuals are described based on the following:

“ ” (Quotation marks):

Used to indicate icons, setting items, and screen titles displayed on the screen.

The screen titles are also indicated in uppercase letters. (Example: FUNCTION screen)

[] (brackets):

Used to indicate keys.

Routes to the set modes and setting screens

Routes to the set mode, setting screen and the setting items are shown in the following manner.

MENU » **SET > Display > Display Type**

Instruction example

◇ Selecting the display background

1. Select the “Display Type” screen.

MENU » **SET > Display > Display Type**

2. Select the desired background between A and B

Detailed instruction

1. Push **MENU**.

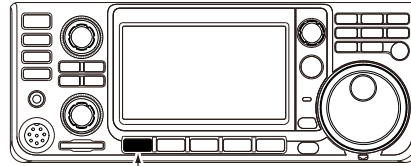

Push

- Opens the MENU screen.

2. Touch **[SET]**.



MENU screen

- Opens the SET screen.

3. Rotate **(MULTI)**, and then push **(MULTI)** to select “Display.”

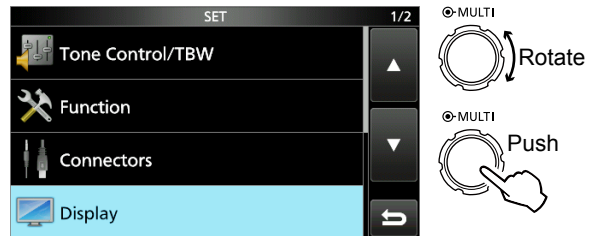

SET screen

4. Rotate **(MULTI)**, and then push **(MULTI)** to select “Display Type.”

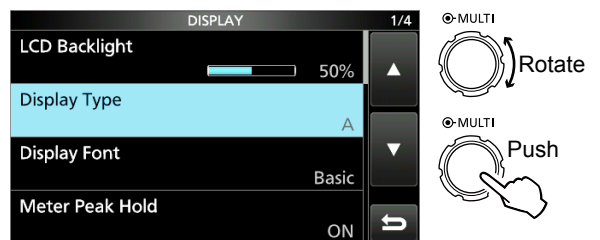

DISPLAY screen

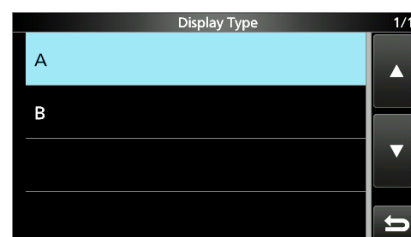

“Display Type” screen

PRECAUTIONS

⚠ **DANGER HIGH RF VOLTAGE! NEVER** touch an antenna or antenna connector while transmitting. This could cause an electrical shock or burn.

⚠ **DANGER! NEVER** operate the transceiver near unshielded electrical blasting caps or in an explosive atmosphere. This could cause an explosion and death.

⚠ **WARNING RF EXPOSURE!** This device emits Radio Frequency (RF) energy. Extreme caution should be observed when operating this device. If you have any questions regarding RF exposure and safety standards please refer to the Federal Communications Commission Office of Engineering and Technology's report on Evaluating Compliance with FCC Guidelines for Human Radio Frequency Electromagnetic Fields (OET Bulletin 65).

⚠ **WARNING! NEVER** operate the transceiver with a headset or other audio accessories at high volume levels. If you experience a ringing in your ears, reduce the volume or discontinue use.

⚠ **WARNING! NEVER** apply AC power to the [DC13.8V] socket on the transceiver rear panel. This could cause a fire or damage the transceiver.

⚠ **WARNING! NEVER** apply more than 16 V DC to the [DC13.8V] socket on the transceiver rear panel. This could cause a fire or damage the transceiver.

⚠ **WARNING! NEVER** reverse the DC power cable polarity. This could cause a fire or damage the transceiver.

⚠ **WARNING! NEVER** remove the fuse holder on the DC power cable. Excessive current caused by a short could cause a fire or damage the transceiver.

⚠ **WARNING! NEVER** let metal, wire or other objects contact the inside of the transceiver, or make incorrect contact with connectors on the rear panel. This could cause an electric shock or damage the transceiver.

⚠ **WARNING! NEVER** operate or touch the transceiver with wet hands. This could cause an electric shock or damage to the transceiver.

⚠ **WARNING!** Immediately turn OFF the transceiver power and remove the DC power cable from the transceiver if it emits an abnormal odor, sound or smoke. Contact your Icom dealer or distributor for advice.

⚠ **WARNING! NEVER** put the transceiver on an unstable place where the transceiver may suddenly move or fall. This could cause an injury or damage the transceiver.

⚠ **WARNING! NEVER** operate the transceiver during a lightning storm. It may result in an electric shock, cause a fire or damage the transceiver. Always disconnect the power source and antenna before a storm.

CAUTION: NEVER expose the transceiver to rain, snow or any liquids.

CAUTION: NEVER change the internal settings of the transceiver. This could reduce transceiver performance and/or damage to the transceiver. The transceiver warranty does not cover any problems caused by unauthorized internal adjustments.

CAUTION: NEVER install or place the transceiver in a place without adequate ventilation, or block any cooling vents on the top, rear, sides or bottom of the transceiver. Heat dissipation may be reduced and damage the transceiver.

CAUTION: NEVER use harsh solvents such as Benzine or alcohol when cleaning, as they will damage the transceiver surfaces.

CAUTION: NEVER leave the transceiver in areas with temperatures below -10°C ($+14^{\circ}\text{F}$) or above $+60^{\circ}\text{C}$ ($+140^{\circ}\text{F}$) for mobile operations.

CAUTION: NEVER place the transceiver in excessively dusty environments. This could damage the transceiver.

DO NOT place the transceiver against walls or put anything on top of the transceiver. This may overheat the transceiver.

BE CAREFUL! The Main unit will become hot when operating the transceiver continuously for long periods of time.

CAUTION: If you use a linear amplifier, set the transceiver's RF output power to less than the linear amplifier's maximum input level. Otherwise, a high input could damage the linear amplifier.

CAUTION: Use only Icom supplied or optional microphones. Other manufacturer's microphones may have different pin assignments, and could damage the connector and/or the transceiver.

NEVER place the transceiver in an insecure place to avoid inadvertent use by unauthorized persons.

Turn OFF the transceiver's power and/or disconnect the AC power cable when you will not use the transceiver for a long period of time.

Turn OFF the transceiver's power and/or disconnect the DC power cable when you will not use the transceiver for long period of time.

The LCD display may have cosmetic imperfections that appear as small dark or light spots. This is not a malfunction or defect, but a normal characteristic of LCD displays.

Operate the transceiver that complies with your local laws and regulations.

Depending on countries and/or regions, transceiver's output power and/or operations on specific frequencies may be restricted to avoid interferences with existing radio stations or services.

Front panel	1-2
Rear panel.....	1-4
Touch screen	1-5
◇ MENU screen	1-7
◇ FUNCTION screen	1-7
◇ QUICK MENU.....	1-7
◇ Multi-function menus.....	1-8
Multi-function dial.....	1-8
Keyboard entering and editing.....	1-9
◇ Entering and editing characters	1-9
◇ Keyboard types.....	1-9
◇ Entering and editing	1-9
◇ Entering and editing example	1-10

1 PANEL DESCRIPTION

Front panel

This section describes the keys, controls and dials that you use to operate the IC-7300. Refer to the pages posted beside each key, control, or dial for details.

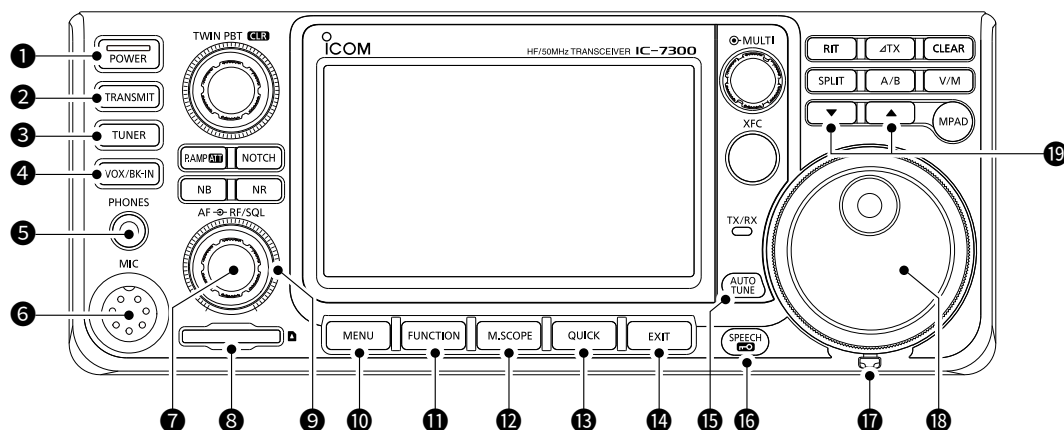

- 1 POWER KEY** **POWER** (p. 3-2)
Turns the transceiver ON or OFF.
- 2 TRANSMIT KEY** **TRANSMIT** (p. 3-10)
Toggles between transmit and receive.
- 3 ANTENNA TUNER KEY** **TUNER** (p. 11-2)
Turns the antenna tuner ON or OFF, or activates the tuner.
- 4 VOX/BREAK-IN KEY** **VOX/BK-IN**
Turns the VOX function (p. 4-10) and Break-in function (p. 4-15) ON or OFF.
- 5 HEADPHONE JACK** **[PHONES]** (p. 2-2)
Connects to standard stereo headphones.
- 6 MICROPHONE CONNECTOR** **[MIC]** (p. 2-2)
Connects to the supplied or an optional microphone.
- 7 VOLUME CONTROL** **(AF-RF/SQL)** (p. 3-2)
Adjusts the audio output level.
- 8 SD CARD SLOT** **[SD CARD]** (p. 8-2)
Accepts an SD card.
- 9 RF GAIN CONTROL/SQUELCH CONTROL** **(AF-RF/SQL)** (p. 3-10)
Adjusts the RF gain and squelch threshold levels.
- 10 MENU KEY** **MENU** (p. 1-7)
Opens the MENU screen.
- 11 FUNCTION KEY** **FUNCTION** (p. 1-7)
Displays the FUNCTION screen.
- 12 MINI SCOPE KEY** **M.SCOPE** (p. 5-4)
Displays the Mini Scope or Spectrum Scope.
- 13 QUICK KEY** **QUICK** (p. 1-7)
Displays the QUICK MENU.
- 14 EXIT KEY** **EXIT** (p. 1-7)
Exits a setting screen or returns to the previous screen.
- 15 AUTO TUNE KEY** **(AUTO TUNE)** (p. 4-16)
Automatically tunes the operating frequency to a received CW signal.
- 16 SPEECH/LOCK KEY** **(SPEECH/LOCK)**
Announces the operating frequency or receiving mode (p. 13-2), or electronically locks **(MAIN DIAL)** (p. 3-10).
- 17 FRICTION ADJUSTER** (p. 13-2)
Adjusts the friction of **(MAIN DIAL)**.
- 18 MAIN DIAL** **(MAIN DIAL)** (p. 3-4)
Changes the operating frequency.
- 19 MEMORY CHANNEL UP/DOWN KEY** **(▲/▼)** (p. 9-3)
Changes the Memory channel.

1 PANEL DESCRIPTION

Front panel

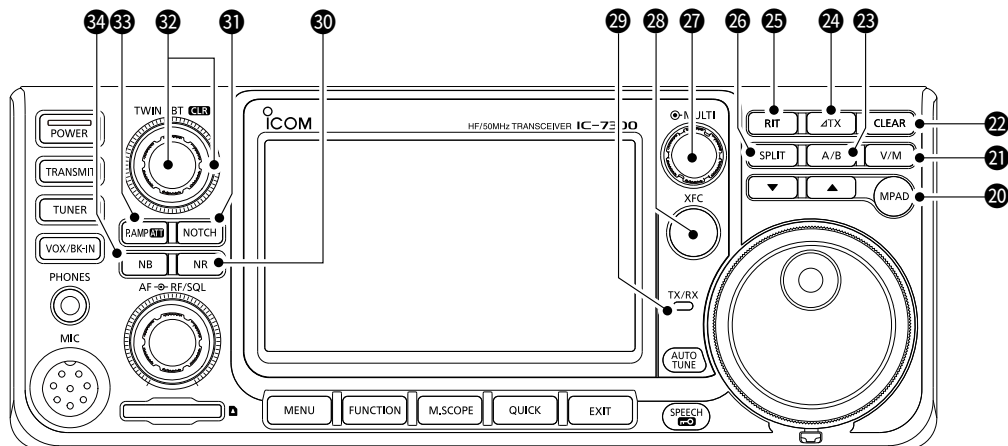

20 MEMO PAD KEY **MPAD** (p. 9-6)

Sequentially calls up the contents in the Memo Pads, or saves the displayed contents into the Memo Pad.

21 VFO/MEMORY KEY **V/M** (p. 3-2)

Switches between the VFO and Memory mode, or copies the memory channel contents to the VFO.

22 CLEAR KEY **CLEAR**

Clears the RIT (p. 4-3) or ΔTX shift frequency (p. 4-11).

23 A/B KEY **A/B** (p. 3-2)

Switches between VFO A and VFO B, or sets the selected VFO's frequency to the other VFO.

24 ΔTX KEY **ΔTX** (p. 4-11)

Turns the ΔTX function ON or OFF.

25 RIT KEY **RIT** (p. 4-3)

Turns the Receiver Incremental Tuning (RIT) function ON or OFF.

26 SPLIT KEY **SPLIT** (p. 4-13)

Turns the Split function ON or OFF.

27 MULTI-FUNCTION CONTROL **MULTI** (p. 1-8)

Displays the Multi-function menu for various adjustments, or selects a desired item.

28 TRANSMIT FREQUENCY CHECK KEY **XFC** (p. 4-13)

Enables you to monitor the transmit frequency while holding it down in the Split mode.

29 TX/RX INDICATOR (p. 3-10)

Lights red while transmitting and lights green while receiving.

30 NOISE REDUCTION KEY **NR** (p. 4-9)

Turns the Noise Reduction function ON or OFF.

31 NOTCH KEY **NOTCH** (p. 4-9)

Turns the Notch filter ON or OFF.

32 TWIN PASSBAND TUNING CONTROL **TWIN PBT CLR** (p. 4-5)

Adjusts the IF filter's passband width by rotating, and clears the setting by holding down for 1 second.

33 PREAMP/ATTENUATOR KEY **P.AMP ATT** (p. 4-3)

Turns ON or OFF, and selects one of two receive RF preamplifiers or turns the Attenuator ON or OFF.

34 NOISE BLANKER KEY **NB** (p. 4-8)

Turns the Noise Blanker ON or OFF.

Rear panel

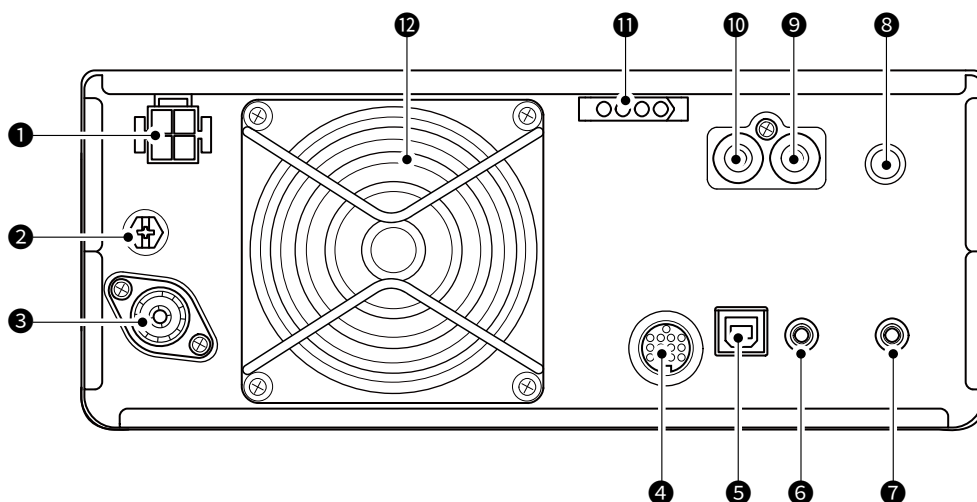

1 DC POWER SOCKET [DC 13.8 V] (p. 2-3)

Accepts 13.8 V DC through the DC power cable.

2 GROUND TERMINAL [GND] (p. 2-3)

Connects to the ground to prevent electrical shocks, TVI, BCI and other problems.

3 ANTENNA CONNECTOR [ANT] (p. 2-3)

Connects to a 50 Ω PL-259 coax connector.

4 SOCKET [ACC] (p. 2-3)

Connects to devices to control an external unit or to control the transceiver.

5 USB PORT (B TYPE) [USB] (p. 2-3)

Connects to a PC.

6 CI-V REMOTE CONTROL JACK [REMOTE] (p. 2-3)

Connects to a PC, Icom linear amplifier, or other transceiver for external control.

7 EXTERNAL SPEAKER JACK [EXT-SP] (p. 2-3)

Accepts a 4~8 Ω external speaker.

8 KEY JACK [KEY] (p. 2-3)

Connects to a straight key, external electronic keyer, or a paddle with 6.35 mm (1/4") stereo plug.

9 SEND CONTROL JACK [SEND] (p. 2-3)

Connects to control transmit with non-Icom external units.

10 ALC INPUT JACK [ALC] (p. 2-3)

Connects to the ALC output jack of a non-Icom linear amplifier.

11 TUNER CONTROL SOCKET [TUNER] (p. 2-3)

Accepts the control cable from an optional AH-730 AUTOMATIC ANTENNA TUNER or AH-740 AUTOMATIC TUNING ANTENNA.

12 COOLING FAN



Cools the PA unit when necessary.

1 PANEL DESCRIPTION

Touch screen

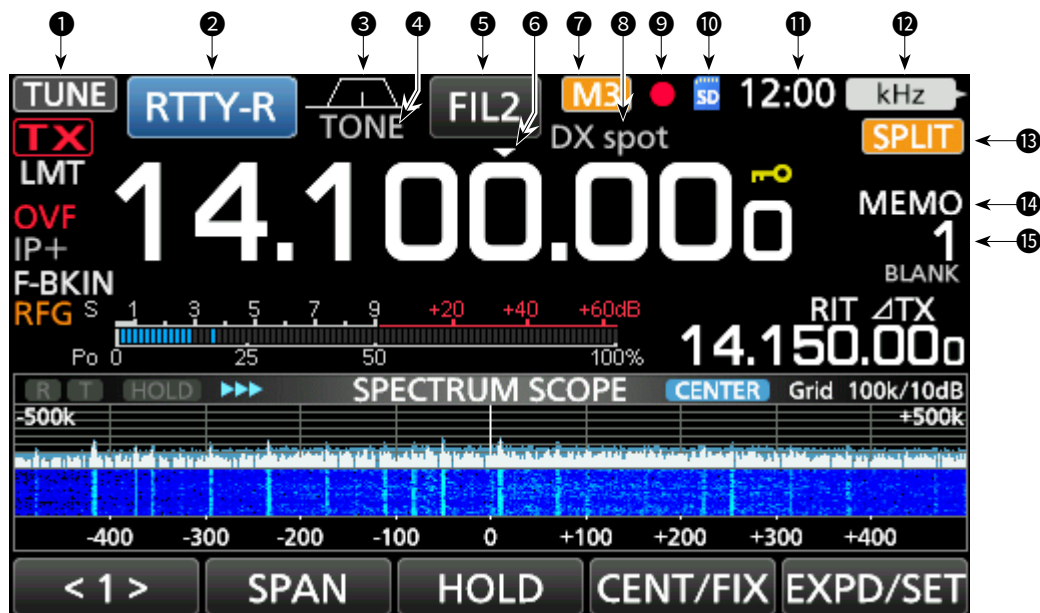
This section describes the icons, screens, dialogs, readouts and so on that are displayed on the IC-7300 screen. Refer to the pages posted beside each item for details.







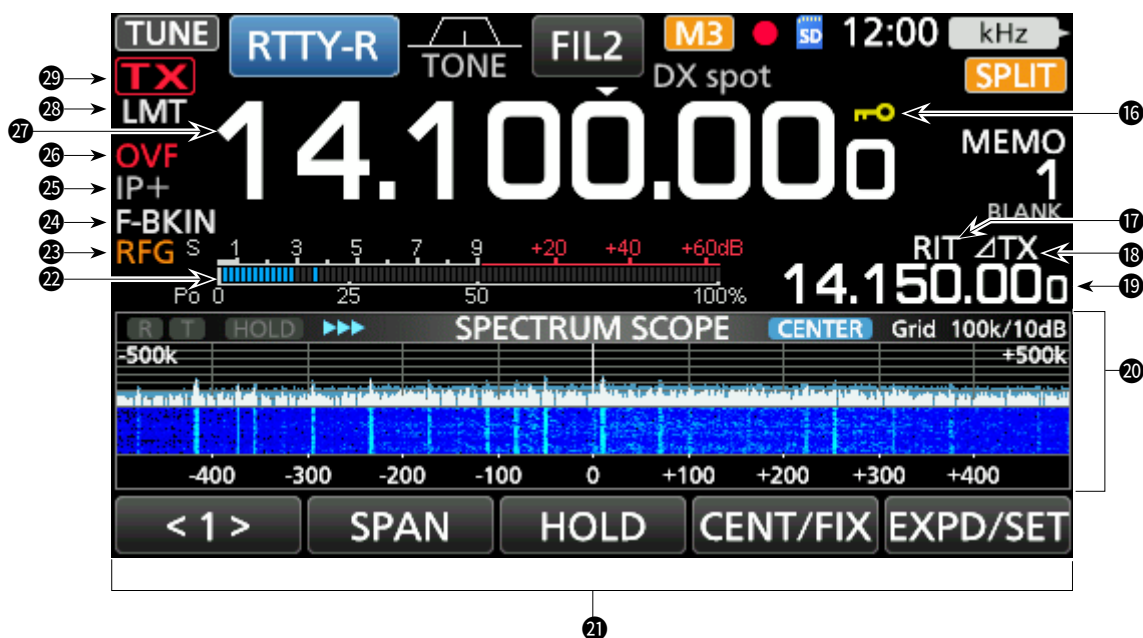

- 1 TUNE ICON** **TUNE** (p. 11-2)
Appears while tuning the antenna.
- 2 MODE INDICATOR** **RTTY-R** (p. 3-3)
Displays the selected operating mode.
- 3 PASSBAND WIDTH INDICATOR**  (p. 4-5)
Graphically displays the passband width for twin PBT operation and the center frequency for IF shift operation.
- 4 TONE INDICATOR** **TONE** (p. 4-29)
Displays the selected tone type in the tone operation mode.
- 5 IF FILTER INDICATOR** **FIL2** (p. 4-6)
Displays the selected IF filter.
- 6 QUICK TUNING ICON**  (p. 3-4)
Appears when the Quick Tuning Step function is ON.
- 7 M1~M8/T1~T8 ICON** **M3**
Displays “M1”~“M8” while “External Keypad” on the CONNECTORS screen is set to ON and using the Memory Keyer function (p. 4-18). Displays “T1”~“T8” while using the Voice TX memory. (p. 7-4)
- 8 MEMORY NAME READOUT/AUTO TUNE ICON**
Displays the memory name if entered (p. 9-5), or displays the “AUTOTUNE” icon when the Auto Tuning function is ON (p. 4-16).
- 9 VOICE RECORDER ICON**  (p. 6-2)
Appears while recording.
- 10 SD CARD ICON** **SD** (p. 8-2)
Appears when an SD card is inserted, or blinks while accessing the SD card.
- 11 CLOCK READOUT** **23:00** (p. 12-13)
Displays the current local time.
Touch the readout to display both the current local time and UTC time.
- 12 FUNCTION INDICATOR FOR MULTI-FUNCTION CONTROL** **kHz** (p. 1-8)
Displays the function that is assigned to **(MULTI)**.
- 13 SPLIT ICON** **SPLIT** (p. 4-13)
Appears when the Split function is ON.
- 14 VFO/MEMORY ICON** **MEMO** (p. 3-2)
“VFO A” or “VFO B” appears when the VFO mode is selected, and “MEMO” appears when the Memory mode is selected.
- 15 MEMORY CHANNEL READOUT** **1** (p. 3-2)
Displays the selected memory channel number.

1 PANEL DESCRIPTION

Touch screen



- 16 LOCK ICON**  (p. 3-10)
Appears while the Lock Function is ON.
1/4 appears while the 1/4 Tuning function is ON.
(p. 3-5)
- 17 RIT ICON**  (p. 4-3)
Appears while the RIT function is ON.
- 18 ΔTX ICON**  (p. 4-11)
Appears while the ΔTX function is ON.
- 19 SHIFT FREQUENCY READOUT**
Displays the shift offset of the RIT (p. 4-3) or ΔTX (p. 4-11) functions, while the functions are ON.
- 20 SPECTRUM SCOPE SCREEN** (p. 5-2)
Displayed while using the Spectrum Scope.
- 21 FUNCTION DISPLAY**
Displays the operating parameters, modes, frequencies and indicators, depending on your selections.
- 22 MULTI-FUNCTION METER** (p. 3-11)
Displays various strengths and levels, depending on the function you select.
- 23 RF GAIN ICON**  (p. 3-10)
Appears when **AF-RF/SQ** (outer) is set to the counterclockwise from the 11 o'clock position. The icon indicates that the RF gain is reduced.
- 24 BK-IN/F-BKIN/VOX INDICATOR**  (p. 4-15)
Appears while the Semi Break-in, Full Break-in or VOX function is ON.
- 25 IP PLUS ICON** (p. 4-7)
Appears when the IP Plus function is ON.
- 26 OVF ICON** (p. 3-10)
Appears when an excessively strong signal is received.
- 27 FREQUENCY READOUT** (p. 3-4)
Displays the operating frequency.
- 28 LMT/INH ICON**  (p. 13-4)
 - LMT** appears if the power amplifier temperature becomes extremely high and the Protection function is activated after transmitting continuously for long periods of time.
 - INH** appears when the Transmitter Lockout function is activated.
- 29 TX STATUS INDICATOR**  (p. 3-10)
Displays the transmit status of the displayed frequency.
 - TX** appears while transmitting.
 - TX** appears when the selected frequency is outside of the amateur band frequency range.
 - TX** appears while the transmitter is inhibited (p. 3-4)

1 PANEL DESCRIPTION

Touch screen

◇ MENU screen

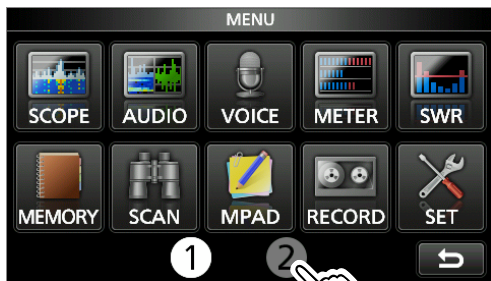

- Open the MENU screen by pushing **MENU**.
 - ① To close the MENU screen, push **EXIT**.
 - ① Touching [①] or [②] at the bottom of the screen selects MENU screen 1 or 2.

◇ FUNCTION screen



FUNCTION screen

- Open the FUNCTION screen by pushing **FUNCTION**.
 - ① To close the FUNCTION screen, push **EXIT**.

FUNCTION screen list

P.AMP/ATT	AGC ^{*2}	NOTCH ^{*2}	NB ^{*2}
OFF	FAST	OFF	OFF
P.AMP1	MID	AN	ON
P.AMP2	SLOW	MN	
ATT ^{*1}			
NR ^{*2}	IP+	VOX ^{*2}	BKIN ^{*2}
OFF	OFF	OFF	OFF
ON	ON	ON	BKIN
			F-BKIN
COMP ^{*2}	TONE ^{*2}	TBW	1/4
OFF	OFF	WIDE	OFF
ON	TONE	MID	ON
	TSQL	NAR	
MONI ^{*2}			
OFF			
ON			

- *1 Touch for 1 second to select the function.
- *2 Touch for 1 second to open its function menu.

◇ QUICK MENU

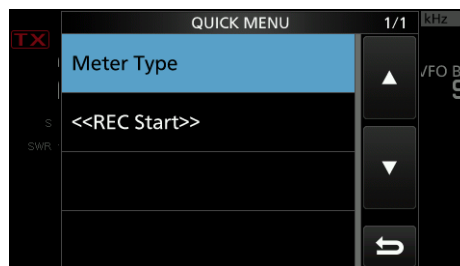

- Open the QUICK MENU by pushing **QUICK**.

1 PANEL DESCRIPTION

Touch screen

◇ Multi-function menus

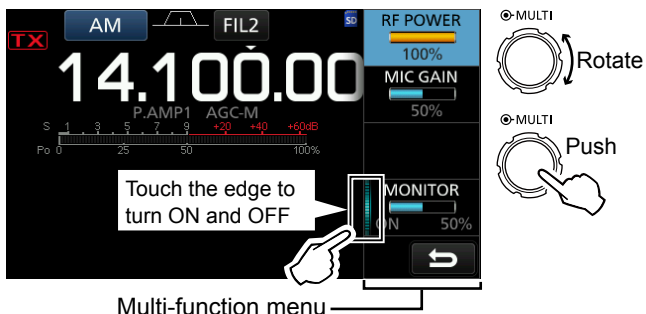

- Open the Multi-function menu by pushing **(MULTI)** (Multi-function control).
- Open different types of menus by holding down **(VOX/BK-IN)**, **(NB)**, **(NR)**, or **(NOTCH)** for 1 second.
- While the Multi-function menu is opened, touch the desired item and rotate **(MULTI)** to set the desired value.

Multi-function menu items

*1 Touch the edge to turn the function ON or OFF, or adjust.

*2 Touch the item for 1 second to adjust by rotating **(MULTI)**, even when the Multi-function menu is closed.

SSB	SSB-D	CW	RTTY
RF POWER*2	RF POWER*2	RF POWER*2	RF POWER*2
MIC GAIN*2	MIC GAIN*2	KEY SPEED*2	TPF*1
COMP*1, 2		CW PITCH*2	
MONITOR*1, 2	MONITOR*1, 2		MONITOR*1, 2
FM	AM	NB	NR
RF POWER*2	RF POWER*2	LEVEL*2	LEVEL*2
MIC GAIN*2	MIC GAIN*2	DEPTH*2	
		WIDTH*2	
MONITOR*1, 2	MONITOR*1, 2		
NOTCH	VOX	BK-IN	
POSITION*2	GAIN*2	DELAY*2	
WIDTH*1	ANTI VOX*2		
	DELAY*2		
	VOICE DELAY SHORT*1		

Multi-function dial

When the Multi-function menu is closed, **(MULTI)** can be enabled to adjust functions by pushing or touching the item for 1 second on the Multi-function menu. The function is displayed in the upper right corner of the screen.

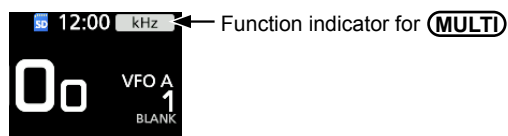

- * On the Multi-function menu, touch the item for 1 second to assign the function to **(MULTI)**. To cancel the function assigned to **(MULTI)**, touch the Function indicator for Multi-function control, or hold down **(MULTI)** for 1 second.

Indicator	Action	
RIT	Rotate	Adjusts the RIT frequency.
	Hold down	Clears the RIT frequency.
ΔTX	Rotate	Adjusts the ΔTX frequency.
	Hold down	Clears the ΔTX frequency.
RIT ΔTX	Rotate	Adjusts the RIT ΔTX frequency.
	Hold down	Clears the RIT ΔTX frequency.
kHz	Changes the operating frequency in kHz steps. (VFO mode only) Rapidly rotating (MULTI) automatically increases the tuning speed.	
M-CH	In the Memory mode, selects Memory channels.	
RF PWR*	Adjusts the transmit output power.	
MIC G*	Adjusts the microphone gain.	
COMP*	Adjusts the Speech Compressor level.	
MONI*	Adjusts the audio level for the Monitor function.	
SPEED*	Adjusts the Keying speed.	
PITCH*	Adjusts the CW pitch.	
NB LEV*	Adjusts the Noise Blanker level.	
NB DEP*	Adjusts the DEPTH (Noise attenuation level).	
NB WID*	Adjusts the WIDTH (Blanking duration time).	
NR LEV*	Adjusts the Noise Reduction level.	
NOTCH*	Adjusts the Notch filter frequency.	
VOX G*	Adjusts the VOX gain.	
A-VOX*	Adjusts the ANTI VOX level.	
VOX D*	Adjusts the VOX delay time.	
BKIN D*	Adjusts the Break-in delay time.	

Keyboard entering and editing

◇ Entering and editing characters

You can enter and edit the items in the following table.

Category	Screen	Selectable characters	Total characters	Information
MENU	MY CALL	A to Z, 0 to 9, (space), / @ - .	10	
MEMORY	MEMORY NAME	A to Z, a to z, 0 to 9, (space), @ % & # + - = [] / () ; : ^ ! ? . ,	10	
FUNCTION	KEYER MEMORY	A to Z, 0 to 9, (space), / ? ^ . , @	70	“*” (asterisk) has its unique use.
	RTTY MEMORY	A to Z, 0 to 9, (space), ! \$ & ? " ' - / . , ; () ↵	70	
	VOICE TX RECORD	A to Z, a to z, 0 to 9, (space), _ ! " # \$ % & ' () * + , - . / ; : < = > ? @ [\] ^ _ ` { } ~	16	
SD Card	FILE NAME	A to Z, a to z, 0 to 9, (space), _ ! " # \$ % & ' () * + , - . / ; : < = > ? @ [\] ^ _ ` { } ~	15	<i>Illegal characters:</i> / ; * < >
PRESET	PRESET NAME	A to Z, a to z, 0 to 9, (space), @ % & # + - = [] / () ; : ^ ! ? . ,	16	

◇ Keyboard types

You can select the Full Keyboard or Ten-key in “Keyboard Type” on the FUNCTION screen. (p. 12-9)

MENU » **SET > Function > Keyboard Type**

① You can also temporarily switch in the QUICK MENU by pushing **QUICK**.

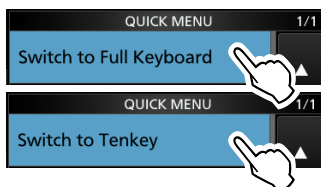

① You can select the full keyboard layout in “Screen Full Keyboard Layout” on the FUNCTION screen. (p. 12-9)

MENU » **SET > Function > Screen Full Keyboard Layout**

◇ Entering and editing

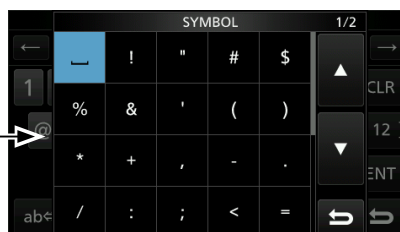
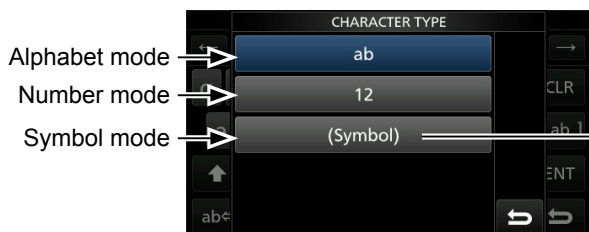
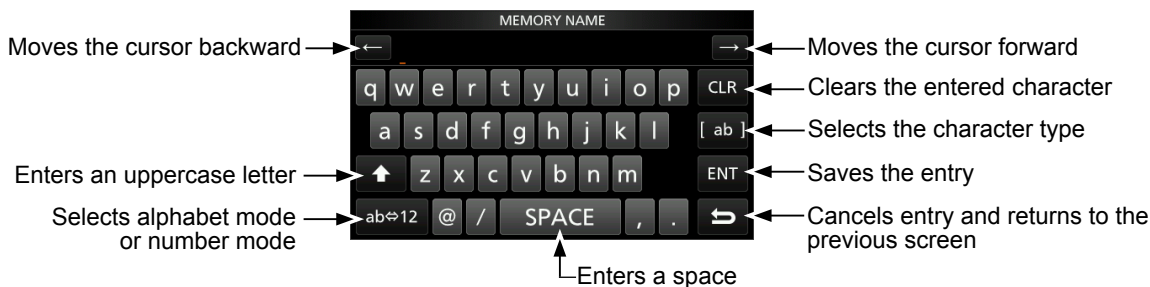

1 PANEL DESCRIPTION

Keyboard entering and editing

◇ Entering and editing example

Entering "DX spot 1" in the Memory channel 2

1. Open the MEMORY screen.



2. Touch the memory channel 2 for 1 second.

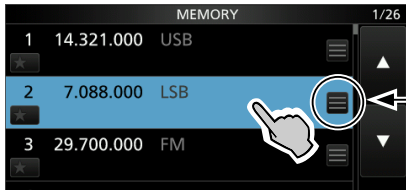

You can also open the QUICK MENU by touching this key.

- Opens the QUICK MENU.

3. Select "Edit Name."

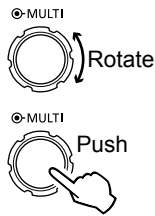
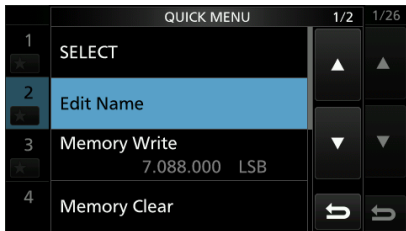

- Opens the MEMORY NAME screen.

4. Touch [↑], and then touch [D].



5. Touch [↑] again, and then touch [X].
6. Touch [SPACE].

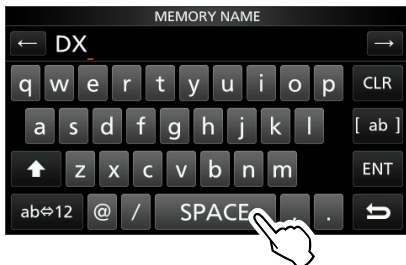

- Enters a space.

7. Touch [s], [p], [o], and then [t].
 8. Touch [SPACE].
- Enters a space.

9. Touch [ab].

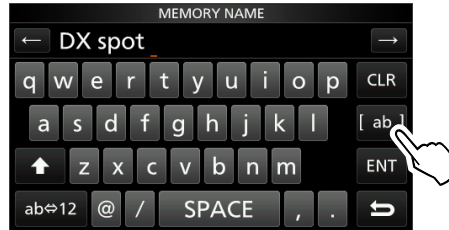

- Opens the entry CHARACTER TYPE screen.

10. Touch [12].

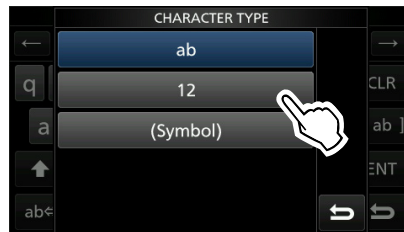

11. Touch [1].
12. Touch [ENT] to save the entry.

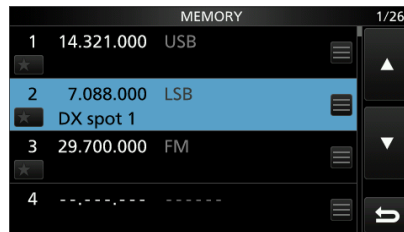
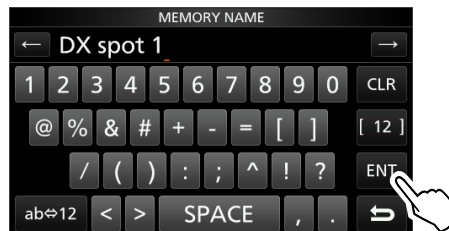

- Returns to the previous screen.

Section 2

INSTALLATION AND CONNECTIONS

Selecting a location	2-2
Heat dissipation	2-2
Grounding	2-2
Front panel connection	2-2
Rear panel connection.....	2-3
Connecting an external DC power supply	2-4
Connecting the antenna tuner	2-4
FSK and AFSK connections	2-5
Linear amplifier connections.....	2-6
◇ Connecting an Icom linear amplifier	2-6
◇ Connecting a non-Icom linear amplifier	2-6

2 INSTALLATION AND CONNECTIONS

Selecting a location

Select a location for the transceiver that allows adequate air circulation, free from extreme heat, cold or vibrations, and other electromagnetic sources.

The transceiver has a stand for desktop use.

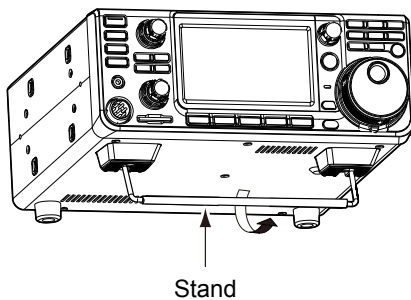

CAUTION: NEVER carry the transceiver by holding the stand, dials, controls and so on. This may damage them.

Heat dissipation

- **DO NOT** place the transceiver against walls or put anything on top of the transceiver. This may block airflow and overheat the transceiver.
- **NEVER** install the transceiver in a place without adequate ventilation. Heat dissipation may be reduced, and the transceiver may be damaged.
- **DO NOT** touch the transceiver after transmitting continuously for long periods of time. The transceiver may become hot.

Grounding

To prevent electrical shock, television interference (TVI), broadcast interference (BCI) and other problems, ground the transceiver using the ground terminal [GND] on the rear panel.

For best results, connect a heavy gauge wire or strap to a long ground rod. Make the distance between the [GND] terminal and the ground as short as possible.

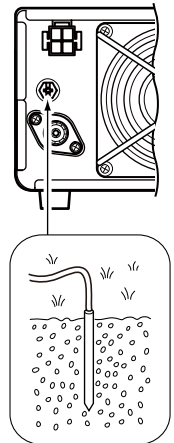

⚠ WARNING! NEVER connect the [GND] terminal to a gas or electric pipe, since the connection could cause an explosion or electric shock.

Front panel connection

[MIC] (Microphone) connector



Using an External Keypad

You can control the CW memory keyer, Voice memory, or RTTY memory keyer transmission from an external keypad by connecting the control circuit to the [MIC] connector. Set the external keypad settings to ON on the CONNECTORS screen to use the external keypad. (p. 12-10)

① The external keypad is not supplied by Icom.

See page 18-3 for the connector details.

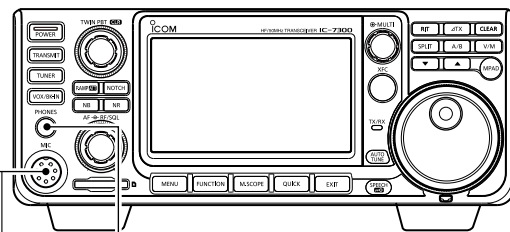

[PHONES] Headphones



Accepts headphones with 8~16 Ω impedance.

- Outputs 5 mW into an 8 Ω load.
- The volume level may differ, depending on the headphones.

Rear panel connection

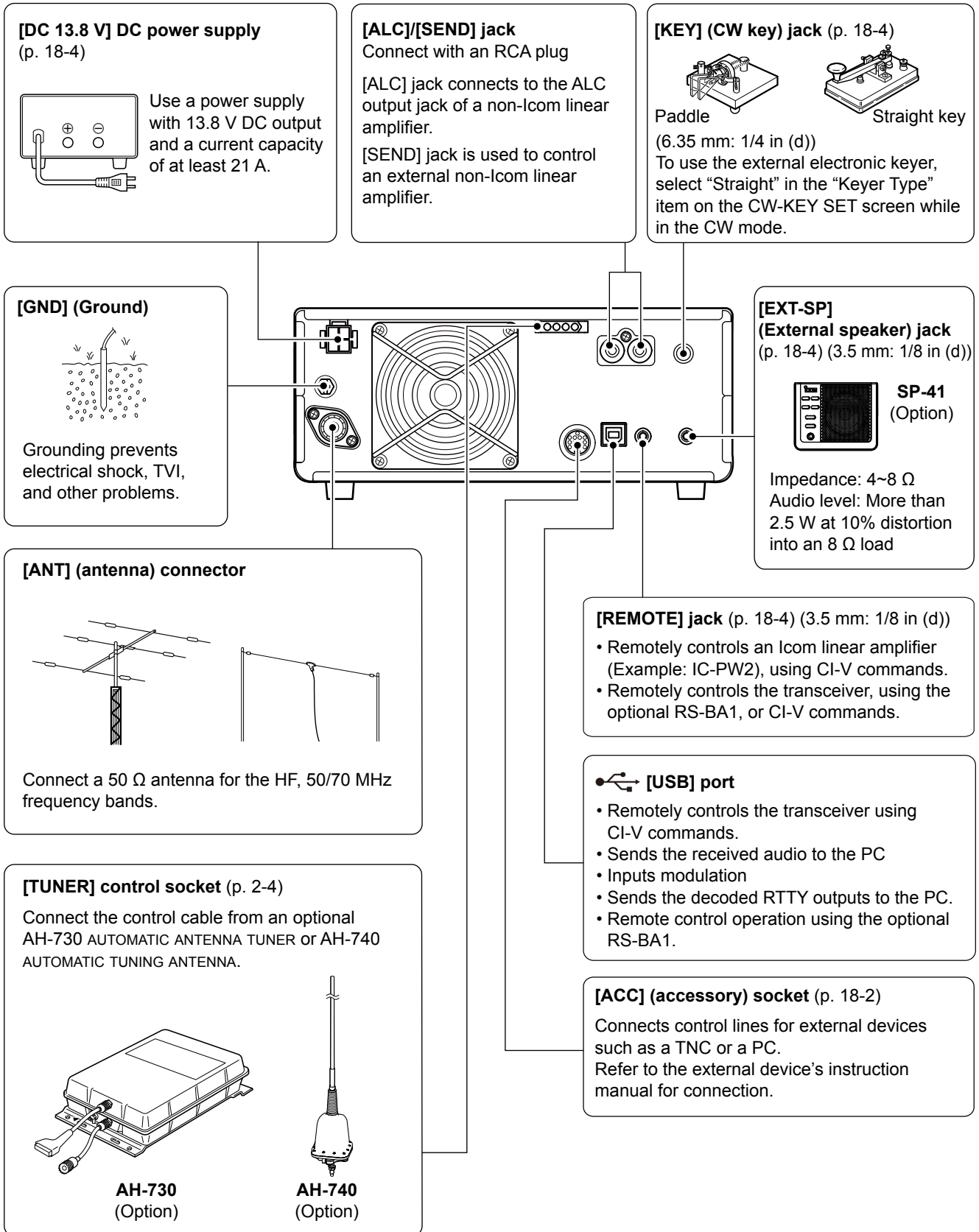

2 INSTALLATION AND CONNECTIONS

Connecting an external DC power supply

Confirm that the transceiver is OFF before connecting the DC power cable.

① When connecting a non-Icom DC power cable, the transceiver needs:

- DC 13.8 V (Capacity: At least 21 Amps)
- A power supply with an over current protective line and low voltage fluctuation or ripple.

CAUTION: DO NOT touch the cooling fan on the rear panel of the transceiver after transmitting continuously for long periods of time. The transceiver becomes extremely hot.

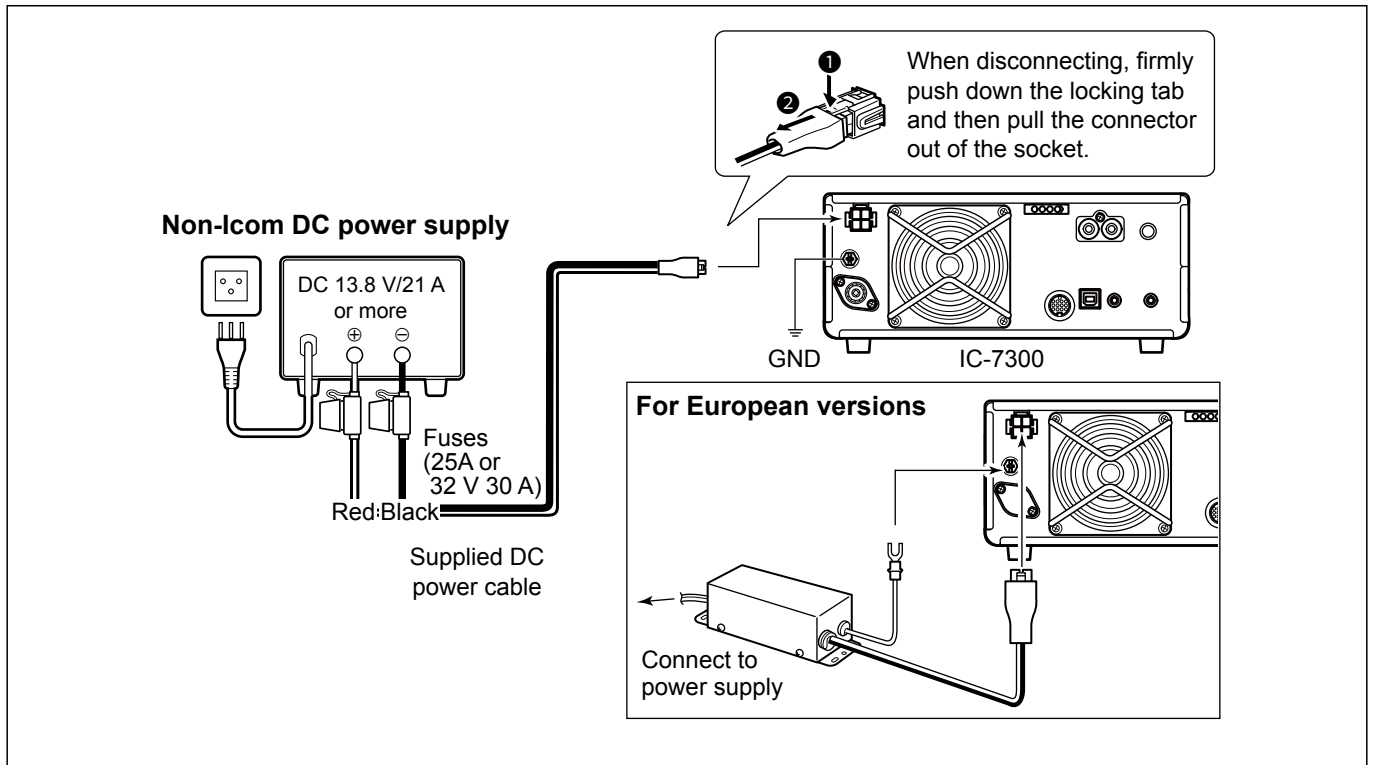

Connecting the antenna tuner

The AH-730 matches the IC-7300 to a long wire antenna more than 7 m/23 ft long (between 1.8 MHz and 50 MHz).

① See the AH-730 instruction manual for installation and connection details.

NOTE: Before connecting, be sure to turn OFF the transceiver power.

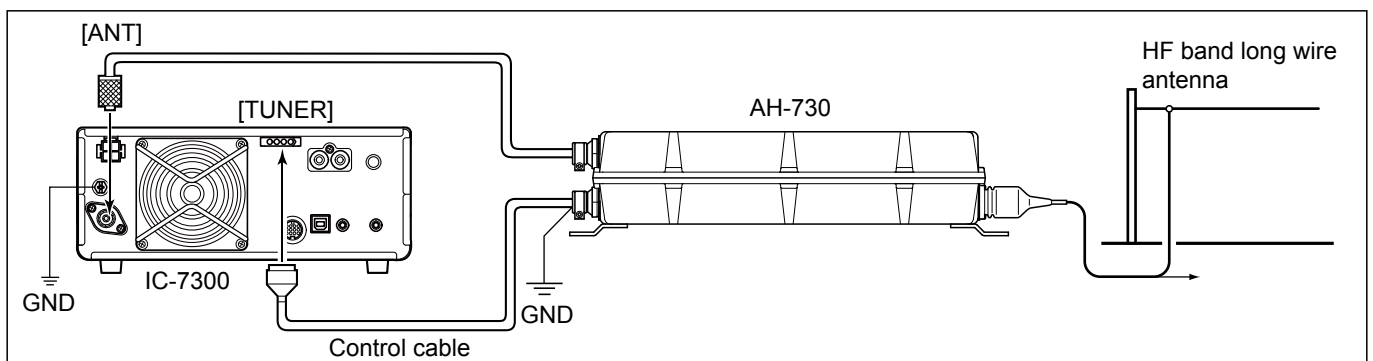

FSK and AFSK connections

The transceiver has a mode key for RTTY. You can use a PC and an application software to operate SSTV, RTTY, AFSK, PSK31, JT65, or FT8 using a USB cable. However, if you want to operate RTTY or other digital modes, you can use the ACC socket on the rear panel through an interface unit. Refer to the software application's instruction manual for setup details.

① Icom does not guarantee the performance of the application software, PC, network device, or network settings.

(1) When using the USB port

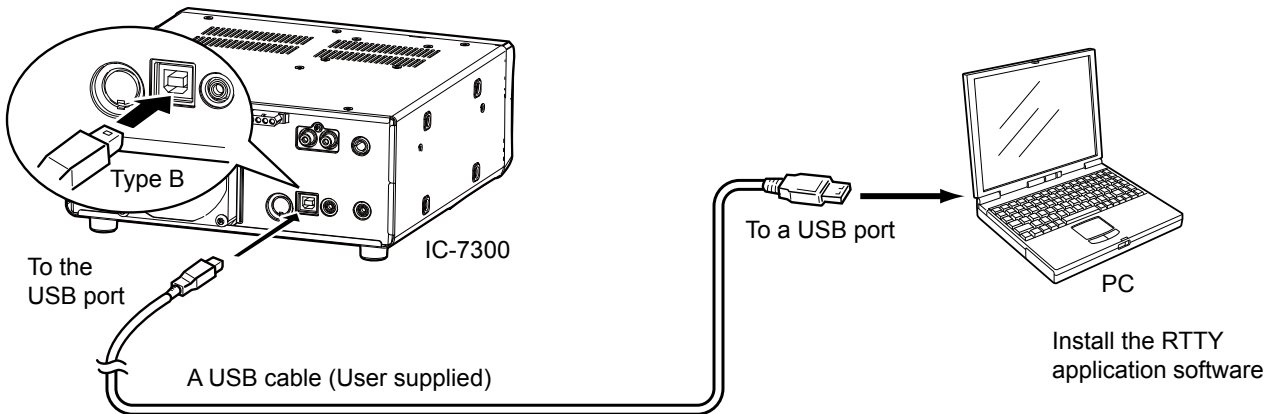

TIP:

- If you set the “USB Serial Function” item to “RTTY Decode,” the decoded RTTY signals are output from the USB port.

MENU » **SET > Connectors > USB Serial Function**

- You can download the USB driver and the installation guide from the Icom website.
<https://www.icomjapan.com/support/>

(2) When using the ACC socket or the microphone connector

• When connecting to [ACC]

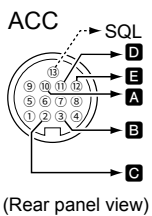

• When connecting to [MIC]

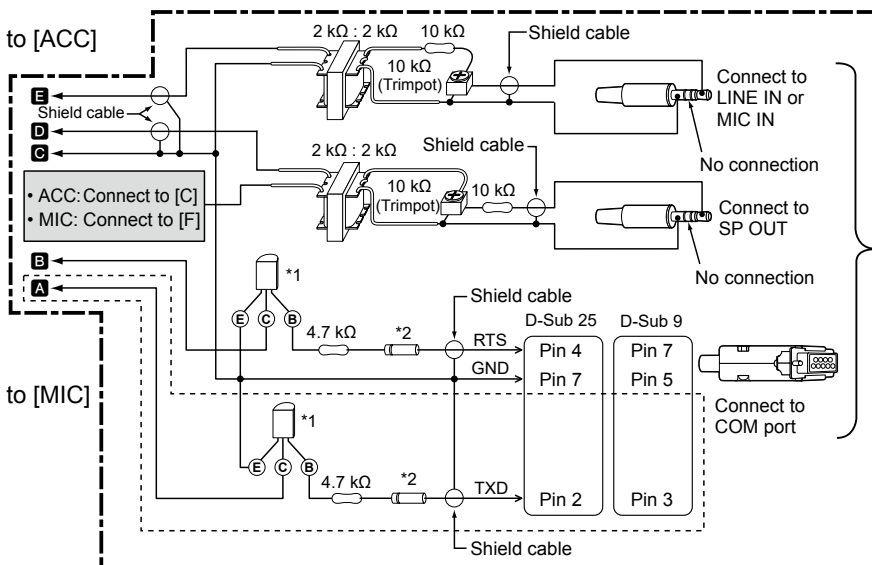
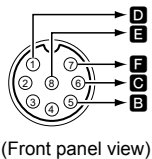

*1 NPN transistor (2SC1815) *2 Switching diode (1S1588)

⋯ The sections shown in short dashes are required only when Baudot RTTY is used in the FSK (RTTY) mode. (Not required for other digital modes such as SSTV or PSK)

Interface circuit example for digital modes (User supplied)

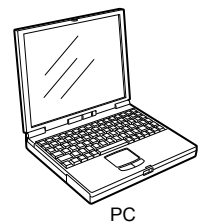

① See pages 18-2 to 18-3 for details on the ACC socket and MIC connector.

NOTE: You can operate ONLY AFSK RTTY when you connect the circuit to the microphone connector.

Linear amplifier connections

◇ Connecting an Icom linear amplifier

See the illustration below to connect an Icom linear amplifier. Refer to the amplifier's instruction manual for operation.

Example: Connecting the optional IC-PW2 HF/50 MHZ ALL BAND 1 KW LINEAR AMPLIFIER

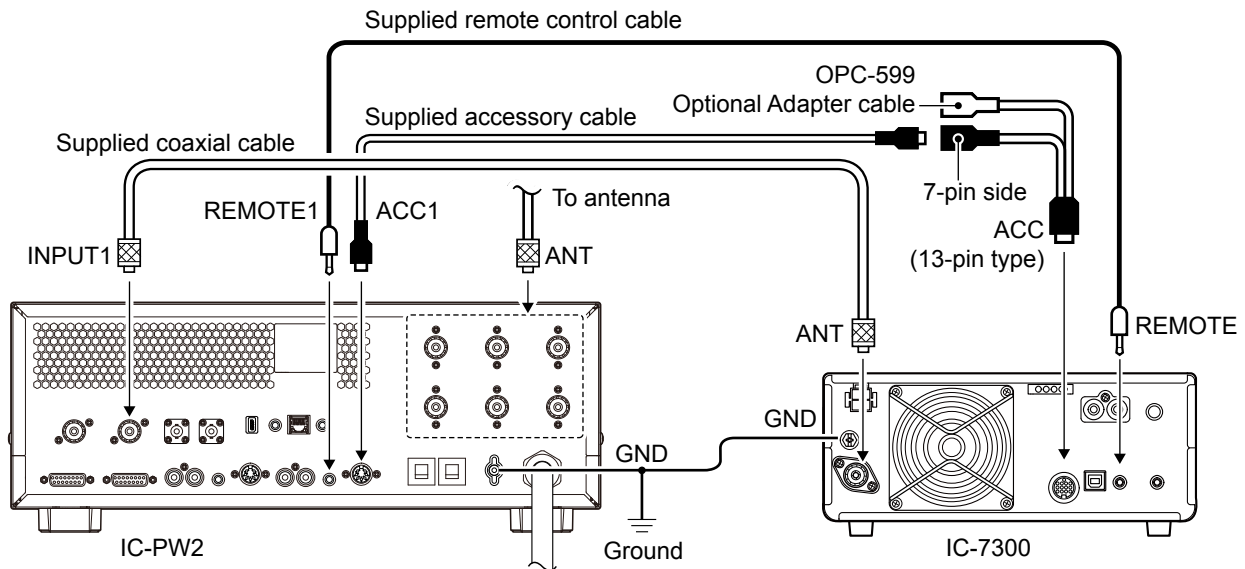

◇ Connecting a non-Icom linear amplifier

See the illustration below to connect a non-Icom linear amplifier.

① We recommend that you use a linear amplifier with a specified input power of 100 watts or more. If you use an amplifier with a specified drive level of less than 100 watts, adjust the IC-7300's output power to the specified level before transmitting. Otherwise, the linear amplifier may be damaged.

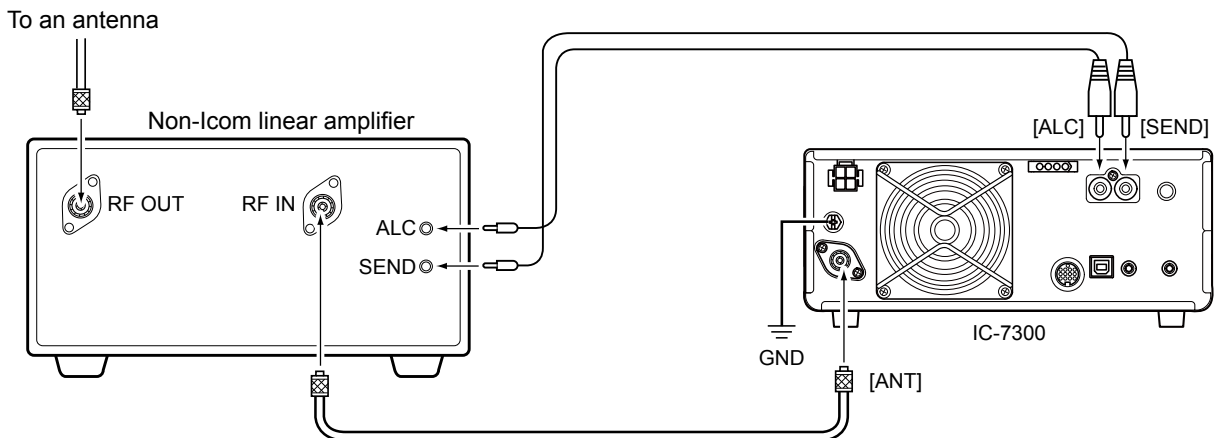

⚠ WARNING!

- The maximum signal level of the [SEND] jack is 16 V/0.5 A DC. Use an external unit if your non-Icom linear amplifier requires a control voltage and/or current greater than specified.
- The ALC input level must be in the range 0 to -4 V. The transceiver does not accept a positive voltage. Non-matched ALC and RF power settings could overheat or damage the linear amplifier.
- When using a linear amplifier such as the IC-PW2, set the RF POWER in the Multi-function menu to keep the ALC meter in the red zone.

① See page 3-10 for details on the RF POWER

① See page 3-11 for details on the ALC zone.

When first applying power	3-2
Turning power ON or OFF	3-2
Adjusting the volume level.....	3-2
About the VFO and Memory modes	3-2
Using the VFO mode.....	3-2
◇ Selecting VFO A or VFO B.....	3-2
◇ Equalizing VFO A and VFO B	3-2
Selecting the operating band.....	3-3
◇ Using the Band Stacking Registers	3-3
Selecting the operating mode.....	3-3
Setting the frequency.....	3-4
◇ Using the Main Dial.....	3-4
◇ About the Tuning Step function.....	3-4
◇ Changing the Tuning Step	3-4
◇ About the 1 Hz step Fine Tuning function	3-4
◇ About the 1/4 Tuning function	3-5
◇ About the Auto Tuning Step function	3-5
◇ Directly entering a frequency	3-5
◇ Band Edge Beep.....	3-6
◇ Entering a Band Edge.....	3-7
RF gain and SQL level	3-10
Dial Lock function	3-10
Basic transmission.....	3-10
Adjusting the transmit output power	3-10
◇ Adjusting the transmit output power	3-10
Meter display	3-11
◇ Meter display selection	3-11
◇ Multi-function meter	3-11
Adjusting the microphone gain	3-11
About the 5 MHz frequency band operation (USA version only).....	3-12

3 BASIC OPERATION

When first applying power

Before turning ON your transceiver for the first time, make sure all of the following are correctly connected.

- DC power cable
- Antenna
- Grounding wire
- Microphone*

*Different devices may be used, depending on the operating mode.

If all listed above are correctly connected, set **AF↔RF/SQL** (inner/outer) to the positions described below.

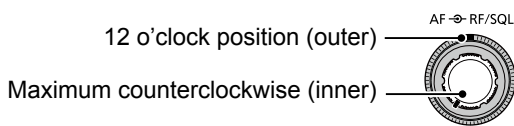

TIP: When you turn OFF the transceiver, it memorizes the current settings. Therefore, when you turn ON the transceiver again, it restarts with the same settings.

Turning power ON or OFF

- To turn ON the transceiver, push **POWER**.
- To turn OFF the transceiver, hold down **POWER** for 2 seconds until “POWER OFF...” is displayed.

Adjusting the volume level

Rotate **AF↔RF/SQL** (inner) to adjust the volume level.

About the VFO and Memory modes

VFO mode

You can set the desired frequency by rotating **MAIN DIAL**.

Memory mode

You can enter contents into the memory channels in the MEMORY list.

Selecting the VFO mode or Memory mode

Push **V/M** to select the VFO or Memory mode.

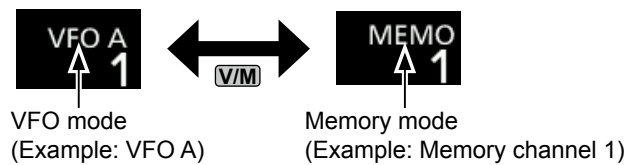

Using the VFO mode

The IC-7300 has 2 Variable Frequency Oscillators (VFO), “A” and “B.” Having 2 VFOs is convenient to quickly select 2 frequencies, or for split frequency operation (p. 4-13). You can use either of the VFOs to operate on a frequency and mode.

◇ Selecting VFO A or VFO B

Push **A/B** to select the VFO A or VFO B.

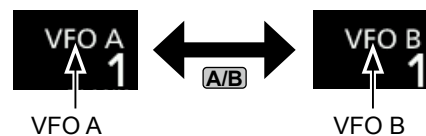

◇ Equalizing VFO A and VFO B

You can set the displayed VFO’s frequency and mode to the VFO that is not displayed.

Hold down **A/B** until 2 short beeps sound.

3 BASIC OPERATION

Selecting the operating band

Do the following steps to change the operating band.

1. Touch the MHz digits. (Example: 14)



- Opens the BAND STACKING REGISTER screen.

2. Touch a band key. (Example: [21])



- Displays a 21 MHz frequency.

◇ Using the Band Stacking Registers

The band stacking register provides 3 memories for each band key to store frequencies and operating modes. This function is convenient to quickly recall previously operated frequencies and modes on the selected band.

Follow the steps below to enter a register on the selected band.

1. Touch the MHz digits for 1 second on the standby screen.

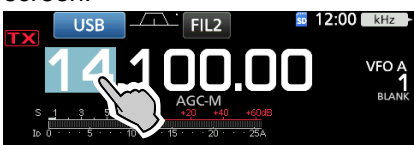

- Opens the BAND STACKING REGISTER screen.
- ① To select a Band Stacking Register in another band, Touch the MHz digits on the standby screen, and then touch a band key for 1 second.

2. Touch a Band key.



- The operating frequency and mode are changed.

Selecting the operating mode

You can select between the SSB, SSB data, CW, CW reverse, RTTY, RTTY reverse, AM, AM data, FM and FM data modes.

1. Touch the mode icon (example: USB).

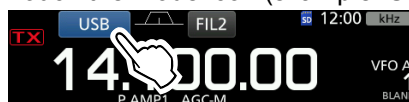

2. In the MODE screen, touch the desired mode key. (Example: CW).

- ① In the SSB, AM or FM modes, the [DATA] key is displayed.



MODE screen

• Operating mode selection list

- ① Touch mode key to select the operating mode

Mode key	Operating mode	
[SSB]	LSB	USB
[CW]	CW	CW-R
[RTTY]	RTTY	RTTY-R
[AM]	AM	
[FM]	FM	
[DATA]	LSB	LSB-D
	USB	USB-D
	AM	AM-D
	FM	FM-D

Selecting the Data mode

You can operate RTTY in the data mode using AFSK (Audio Frequency Shift Keying). (p. 4-31)

- ① When a data mode is selected, you can mute the input from the microphone. (p. 12-10)

MENU » **SET > Connectors > DATA MOD**

(Example: selecting the USB-D mode)

1. While the USB mode is selected, touch the mode icon.
 - Opens the MODE screen.
2. Touch [DATA].



MODE screen

- The USB-D mode is selected.

- ① In the PRESET menu, you can save the combination of the settings for the data mode to quickly change the settings, depending on your operating needs. (p. 13-6)

Setting the frequency

◇ Using the Main Dial

1. Select the desired operating band.
(Example: 21 MHz)



BAND STACKING REGISTER screen

2. Rotate **MAIN DIAL**.

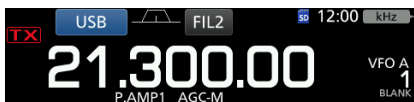

- ① If you cannot change the frequency, make sure the Dial Lock function is turned OFF. (p. 3-10)
- ① **TX** is displayed when you set an amateur radio frequency, and **TX** is displayed when you set a frequency outside the Ham band, or outside your set Band Edges.

◇ About the Tuning Step function

You can set the **MAIN DIAL**'s tuning step for each operating mode. The following steps are set as default.

- SSB/CW/RTTY (TS OFF): 10 Hz
- AM (TS ON): 1 kHz
- FM (TS ON): 10 kHz

Touch the kHz digits to turn the Tuning Step function ON or OFF.

- ① The Tuning Step function's icon "▼" is displayed above the 1 kHz digit.

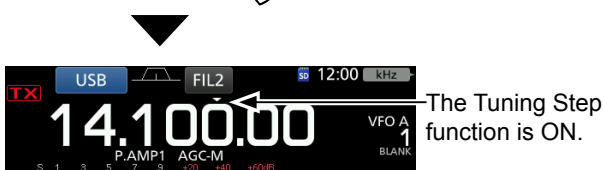

The Tuning Step function is ON.

◇ Changing the Tuning Step

When the Tuning Step function is ON, you can change the tuning steps for each operating mode.

1. Select the desired operating mode. (p. 3-3)
(Example: USB)
2. Touch the kHz digit for 1 second.
• The TS (SSB) screen is displayed.



3. Touch the desired tuning step.
(Example: 0.1 k)
• The tuning step is set and returns to the previous screen.



TS (SSB) screen

The Tuning Step function is ON.

◇ About the 1 Hz step Fine Tuning function

You can use the minimum tuning step of 1 Hz for fine tuning in the SSB, CW and RTTY modes.

Touch the Hz digits for 1 second to turn the Fine Tuning function ON or OFF.

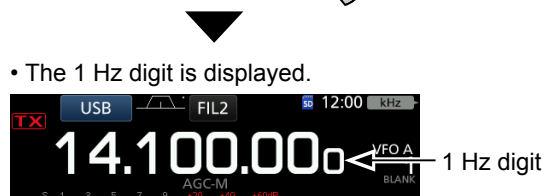

- The 1 Hz digit is displayed.

- ① When using the [UP]/[DN] keys on the microphone, the frequency changes in 50 Hz steps with the Fine Tuning function ON or OFF.

3 BASIC OPERATION

Setting the frequency

◇ About the 1/4 Tuning function

Mode: SSB-D/CW/RTTY

With the Tuning Function OFF, turn ON the 1/4 Tuning function to reduce the tuning speed to 1/4 of the normal speed, for finer tuning.

1. Push **[FUNCTION]**.
 - Opens the FUNCTION screen.
2. Touch **[1/4]**.

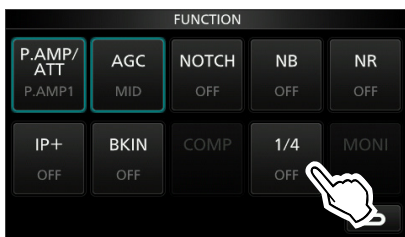

FUNCTION screen

3. Push **[EXIT]**.



◇ About the Auto Tuning Step function

The tuning step automatically changes, depending on the rotation speed of **(MAIN DIAL)**.

① You can change the Auto Tuning Step function settings in the following menu. (p. 12-6)

[MENU] » **SET > Function > MAIN DIAL Auto TS**

◇ Directly entering a frequency

You can set the frequency without rotating **(MAIN DIAL)** by directly entering it on the keypad.

Entering the operating frequency

1. Touch the MHz digits.
(Example: 14)



- Opens the BAND STACKING REGISTER screen.

2. Touch **[F-INP]**.



BAND STACKING REGISTER screen

- Opens the F-INP screen.

3. Start entry with the MHz digits.
 - ① To clear the entry, touch **[CE]**.
 - ① To clear the entry and return to the previous screen, push **[EXIT]**.



F-INP screen (Example:14.025)

4. Touch **[ENT]** to set the entered frequency.
 - Closes the F-INP screen.
 - ① If you touch **[ENT]** when the digits under 100 kHz are not entered, "0" will be automatically entered into the digits that are blank.

Entry examples

- 14.025 MHz: [1], [4], [**(-)**], [0], [2], [5], [ENT]
- 18.0725 MHz: [1], [8], [**(-)**], [0], [7], [2], [5], [ENT]
- 730 kHz: [0], [**(-)**], [7], [3], [ENT]
- 5.100 MHz: [5], [**(-)**], [1], [ENT]
- 7.000 MHz: [7], [ENT]
- Changing from 21.280 MHz to 21.245 MHz: [**(-)**], [2], [4], [5], [ENT]

3 BASIC OPERATION

Setting the frequency

Entering the Split Frequency Offset

1. Touch the MHz digits.
(Example: 14)



- Opens the BAND STACKING REGISTER screen.

2. Touch [F-INP].

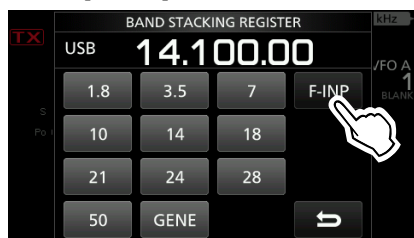

BAND STACKING REGISTER screen

- Opens the F-INP screen.

3. Enter the Split Frequency Offset.

- ① If you want the minus shift direction, touch [*(-)].
- ① Enter the offset between -9.999 MHz and +9.999 MHz (1 kHz steps).



F-INP screen

Touch for -Split

[SPLIT] or
[-SPLIT] is
displayed

4. To save the entry, touch [SPLIT] or [-SPLIT].

- Closes the F-INP screen.

Entry examples

- 10 kHz: [1], [0], [SPLIT]
- -1.025 MHz: [*(-)], [1], [0], [2], [5], [-SPLIT]
- ① After entering, the Split function is automatically turned ON.

Entering a Memory channel

1. Touch **V/M** to select the Memory mode.

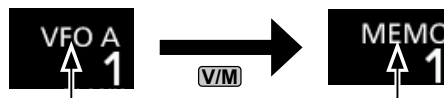

VFO mode
(Example: VFO A)

Memory mode
(Example: Memory channel 1)

2. Touch the MHz digits.
(Example: 14)



- Opens the BAND STACKING REGISTER screen.

3. Touch [F-INP].

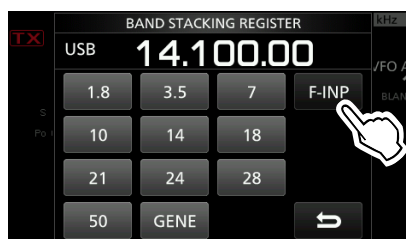

BAND STACKING REGISTER screen

- Opens the F-INP screen.

4. Enter a Memory channel number between 1 and 99. (Memory channel 5)

- ① If you want to set the Program Channel number (P1 or P2), enter "100" for P1, and "101" for P2.



F-INP screen

5. Touch [MEMO] to select the entered channel.
• Closes the F-INP screen.

◇ Band Edge Beep

You will hear a Band Edge Beep and **TX** will be displayed when you tune into or out of an amateur band's frequency range.

- ① You can change the Band Edge Beep settings in the following menu.

MENU » **SET > Function > Band Edge Beep**

3 BASIC OPERATION

Setting the frequency

◇ Entering a Band Edge

When “ON (User)” or “ON (User) & TX Limit” is selected on the “Band Edge Beep” screen, you can enter a total of 30 band edge frequencies.

① Initially, all band edges are entered. Therefore, you must first edit or delete them to enter a new band edge.

② You cannot enter an overlapped frequency or a frequency that is out of the preset transmit frequency.

1. Open the “Band Edge Beep” screen.

MENU » **SET > Function > Band Edge Beep**

2. Select “ON (User)” or “ON (User) & TX Limit.”

① If you select “ON (User) & TX Limit,” you can limit transmission to within the entered frequency range.

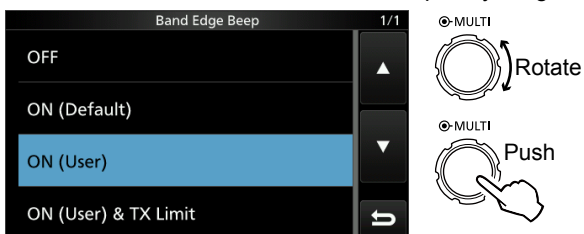

“Band Edge Beep” screen

3. Select “User Band Edge.”

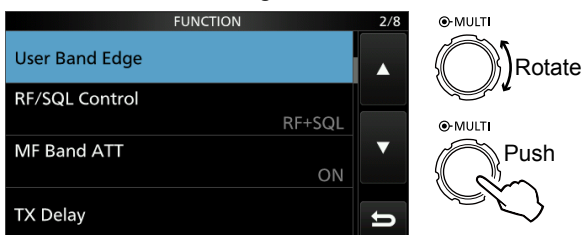

FUNCTION set screen

• Opens the “User Band Edge” screen.

Editing a Band Edge

You can edit a band edge entered as a default or when entering a new band edge.

1. On the FUNCTION set screen, select “User Band Edge.”
2. Touch the band edge you want to edit for 1 second.

(Example: 5: 14.000.000 – 14.350.000 MHz)

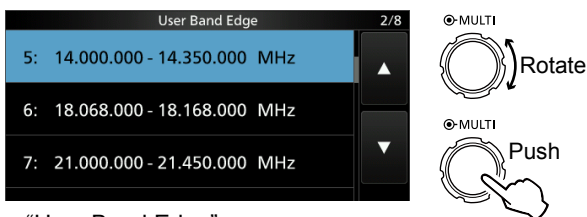

“User Band Edge” screen

3. Edit the lower band edge frequency.
(Example: 14.1)

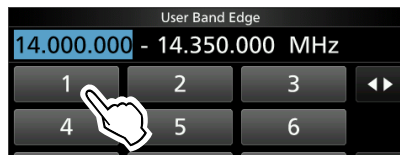

Entry examples

- 14.025 MHz: [1], [4], [•], [0], [2], [5], [ENT]
- 18.0725 MHz: [1], [8], [•], [0], [7], [2], [5], [ENT]
- 730 kHz: [0], [•], [7], [3], [ENT]
- 5.100 MHz: [5], [•], [1], [ENT]
- 7.000 MHz: [7], [ENT]
- Changing from 21.280 MHz to 21.245 MHz: [•], [2], [4], [5], [ENT]

4. Touch [ENT] to save the edited lower band edge frequency.

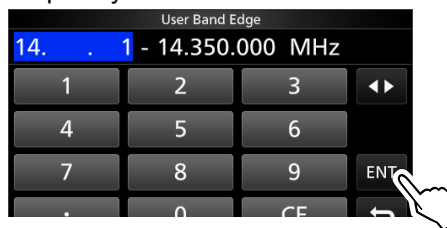

5. Edit the upper band edge frequency.
(Example: 14.25)

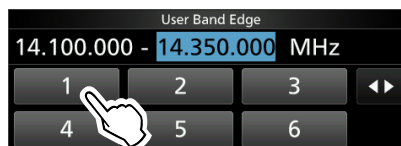

6. Touch [ENT] to save the edited upper band edge frequency.

① The edited band edge is saved and returns to the previous screen.

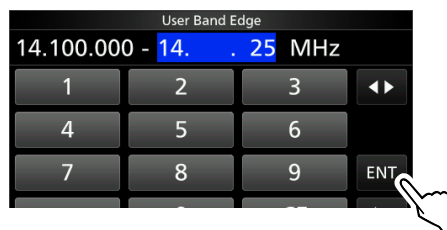

TIP:

- You can also edit the frequency by rotating **MAIN DIAL** or **MULTI**.
- Each band edge must be higher in frequency than the ones above it. If you try to enter a lower frequency than the edges above, the lower frequency edge will be cleared when you push [ENT].

3 BASIC OPERATION

Setting the frequency

◇ Entering a Band Edge

Deleting a Band Edge

To enter a new band edge, first you must delete a preset band edge.

- ① Initially, all band edges are entered. Therefore, you must first edit or delete them to enter a new band edge.
- ① You cannot enter an overlapped frequency or a frequency that is out of the preset transmit frequency.

1. On the FUNCTION set screen, select “User Band Edge.”
2. Touch the desired band edge to delete for 1 second.
(Example: 1: 1.800.000 – 1.999.999 MHz)

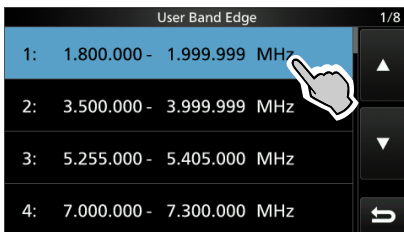

“User Band Edge” screen

3. Touch “Delete.”

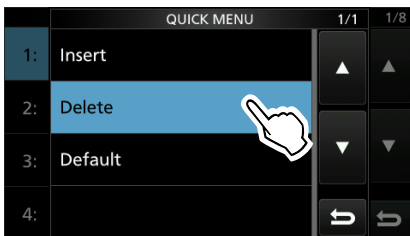

- The selected band edge is deleted and returns to the previous screen.

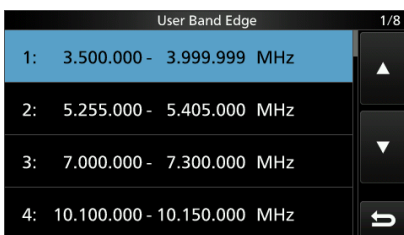

1.800.000 – 1.999.999 MHz is deleted.

Entering a new Band Edge

After you delete or edit the preset band edges, you can enter a new band edge.

1. Open the “User Band Edge” screen.
2. Select a blank band.
(Example: 10)

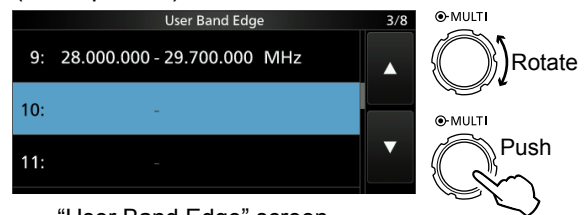

“User Band Edge” screen

3. Enter the lower band edge frequency.
(Example: 51.15)

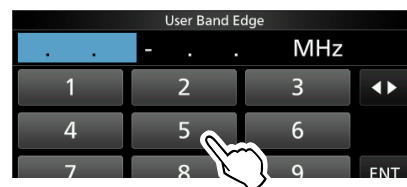

4. Touch [ENT] to save the entered lower band edge frequency.



5. Enter the upper band edge frequency.
(Example: .75)

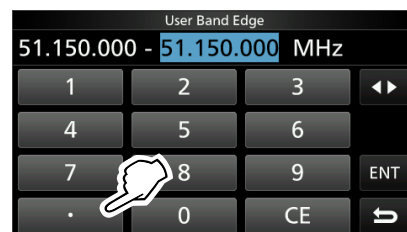

6. Touch [ENT] to save the entered upper band edge frequency.

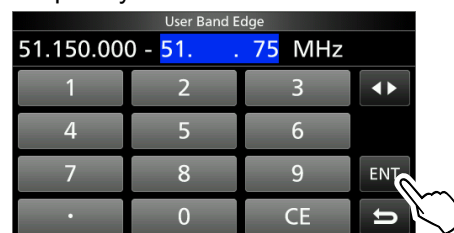

- The entered band edge is saved and returns to the previous screen.

3 BASIC OPERATION

Setting the frequency

◇ Entering a Band Edge

Inserting a Band Edge

After you delete or edit the preset band edges, follow the steps below to insert a band edge.

- ① Initially, all band edges are entered. Therefore, you must first edit or delete them to enter a new band edge.
- ② You cannot enter an overlapped frequency or a frequency that is out of the preset transmit frequency.

1. Open the “User Band Edge” screen.
2. Touch the band edge you want to insert a new band edge above for 1 second.
(Example: 1: 3.500.000–3.999.999 MHz)
③ The new band edge will be inserted above the selected band edge.

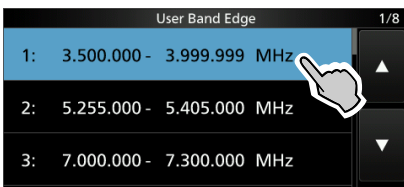

“User Band Edge” screen

3. Touch “Insert.”

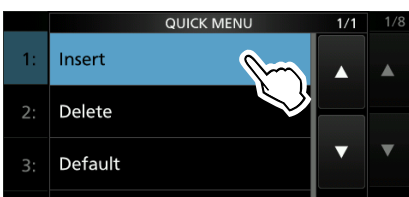

4. Enter the lower band edge frequency.
(Example: 1.85)

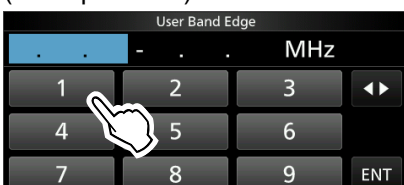

5. Touch [ENT] to save the entered lower band edge frequency.



6. Enter the upper band edge frequency. (Example: .95)

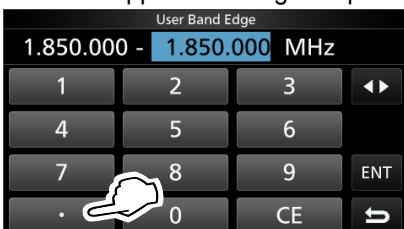

7. Touch [ENT] to save the entered upper band edge frequency.
 - The entered band edge is saved and returns to the previous screen.



Resetting all band edges to presets

The steps below will reset all the band edges to their initial settings. All entered settings will be deleted.

1. Open the “User Band Edge” screen.
2. Touch any band edge for 1 second.

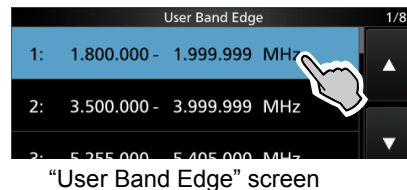

“User Band Edge” screen

3. Touch “Default.”

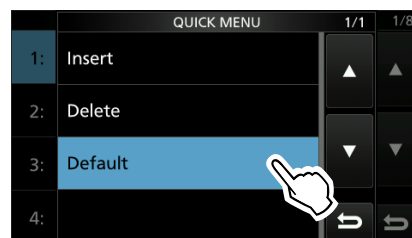

- Displays “Reset All Edges?”

4. Touch [YES].
 - All the band edges reset to the initial settings.

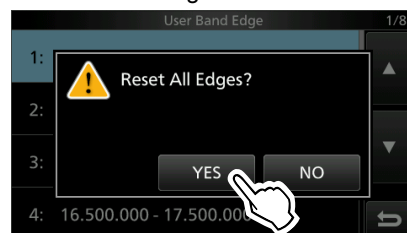

RF gain and SQL level

Rotate (AF/RF/SQL)(outer) to adjust the RF gain and SQL level.

By default, rotating to left (when set to the 12 o'clock position) adjusts the RF gain, and rotating to right adjusts the squelch level as described below.

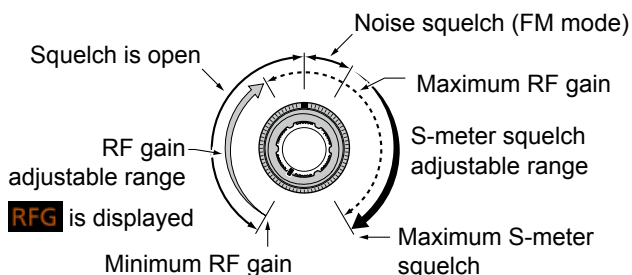

RF gain

Adjust the RF gain to decrease the noise received from a nearby strong station.

- Rotate counterclockwise to reduce the RF gain, which reduces the receive sensitivity. "RFG" appears when (AF/RF/SQL) is set to the counterclockwise from the 11 o'clock position. "RFG" indicates that the RF gain is reduced.
 - ① If a strong signal is received and "OVF" (Overflow) appears, reduce the RF gain until "OVF" disappears.

SQL level

There are 2 types of SQL levels, depending on the operating mode.

Noise squelch

Rotate the (AF/RF/SQL) until the noise just disappears and the TX/RX indicator goes OFF.

S-meter squelch

The S-meter squelch mutes the audio output from the speaker or headphones when the received signal is weaker than the specified S-meter squelch level.

Rotate the (AF/RF/SQL) clockwise from the 12 o'clock position to increase the S-meter threshold level.

- ① You can change the (AF/RF/SQL)(outer) control type in "RF/SQL Control." (p. 12-4)

MENU » **SET > Function > RF/SQL Control**

Dial Lock function

The Dial Lock function prevents frequency changes caused by accidentally moving (MAIN DIAL).

- ① This function electronically locks the dial.

Hold down (SPEECH PO) for 1 second to turn the Dial Lock function ON or OFF.

- "LO" is displayed while the function is ON.
- You can select the Dial lock or Panel lock. (p. 12-6)

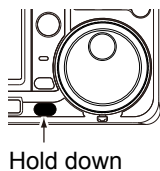

MENU » **SET > Function > Lock Function**

Basic transmission

1. Push (TRANSMIT) or [PTT] to transmit.
 - The TX/RX indicator lights red and TX is displayed while transmitting.
2. Push (TRANSMIT) or release [PTT].
 - Returns to receive.

Adjusting the transmit output power

Before transmitting, monitor your selected operating frequency to make sure you do not cause interference to other stations on the same frequency. It is good amateur practice to listen first, and then, even if nothing is heard, ask if the frequency in use once or twice, before you start operating.

Adjusting the transmit output power

1. Set the operating mode to SSB, CW, RTTY or FM. (p. 3-3)
(Example: USB)
2. Touch the meter to display the Po meter. (p. 3-11)
3. Open the Multi-function menu.

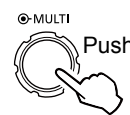

4. Push (TRANSMIT) or hold down [PTT].
 - The Po meter level changes according to your voice level in the SSB mode.
 - The TX/RX indicator lights red and TX is displayed.

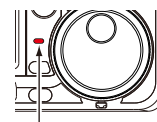

- ① Tune the antenna before you view the power level on the meter. If the antenna is not tuned properly, the meter will not reflect the power level. (p. 11-2)

5. Touch "RF POWER."
6. Adjust the transmit output power to between 0 and 100%.

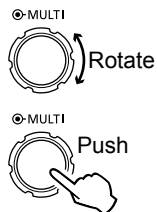
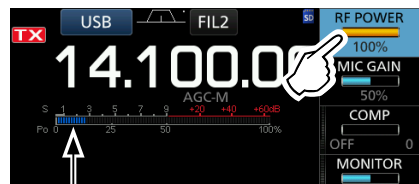

Po meter

- The Po meter displays the RF output power in a percentage. It becomes the S-meter while receiving.
7. Push (TRANSMIT) or release [PTT].
 - Returns to receive.

Meter display

◇ Meter display selection

You can display one of the 6 different transmit parameters (Po, SWR, ALC, COMP, VD and ID) for your convenience.

Touch the parameter to display one of the meters.



◇ Multi-function meter

You can display all the parameters simultaneously.

① The power amplifier temperature (TEMP) meter is also displayed on the Multi-function meter.

Hold down the parameter for 1 second to display the Multi-function meter.

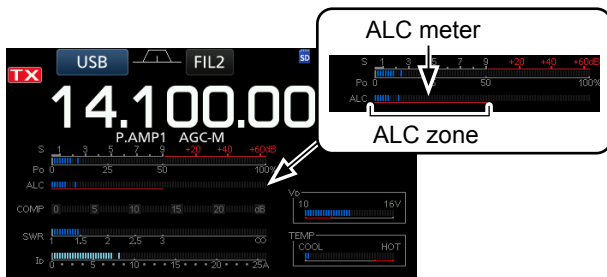

Multi-function meter

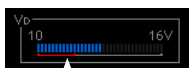

Displays the drain voltage of the final amplifier MOS-FETs.



Displays the temperature of the final amplifier MOS-FETs.

- S:** Displays the receiving signal strength level.
- Po:** Displays the relative RF output power.
- SWR:** Displays the SWR of the antenna at the operating frequency.
- ALC:** Displays the ALC level. When the meter movement shows the input signal level exceeds the allowed level, the ALC limits the RF power. In such cases, decrease the microphone gain level.
- COMP:** Displays the compression level when the speech compressor is used.
- VD:** Displays the drain voltage of the final amplifier MOS-FETs.
- ID:** Displays the drain current of the final amplifier MOS-FETs.
- TEMP:** Displays the temperature of the final amplifier MOS-FETs.

Adjusting the microphone gain

Adjust the microphone gain as described below.

1. Set the operating mode to SSB, AM or FM.
(p. 3-3)
2. Push **(MULTI)** to display the Multi-function menu.
3. Touch "MIC GAIN."

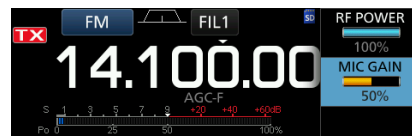

4. Push **(TRANSMIT)** or hold down [PTT] on the microphone.
 - The TX/RX indicator lights red and **TX** is displayed.

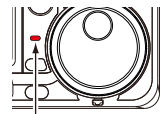

Lights red

① Information

- In the SSB mode, touch the TX meter to select the ALC meter and adjust until the meter reading swings between 30 to 50% of the ALC scale.
- Hold the microphone 5 to 10 cm (2 to 4 inches) from your mouth, then speak at your normal voice level.
- In the AM or FM mode, check the audio clarity with another station, or use the Monitor function (p. 4-11).

5. Rotate **(MULTI)** to adjust the microphone gain.
6. Push **(TRANSMIT)** or release [PTT].
 - Returns to receive

About the 5 MHz frequency band operation (USA version only)

Operation on the 5 MHz frequency band is allowed on 5 discrete frequencies and you must adhere to the following:

- The USB, USB Data, PSK, and CW modes.
- Maximum of 100 watts ERP (Effective Radiated Power)
- Maximum 2.8 kHz bandwidth

It is your responsibility to set all controls so that transmission in this frequency band meets the stringent conditions under which amateur operations may use these frequencies.

TIP: We recommend that you save these frequencies, modes and filter settings into memory channels, for easy recall.

NOTE: To assist you in operating within the rules specified by the FCC, transmission is illegal on any frequencies other than the five shown in the tables below.

For the USB and USB data modes:

The FCC specifies center frequencies on the 5 MHz frequency band. However, the transceiver displays carrier frequency. Therefore, tune the transceiver to 1.5 kHz below the specified FCC channel center frequency.

Transceiver displayed frequency	FCC channel center frequency
5.33050 MHz	5.33200 MHz
5.34650 MHz	5.34800 MHz
5.35700 MHz	5.35850 MHz
5.37150 MHz	5.37300 MHz
5.40350 MHz	5.40500 MHz

For the CW mode:

The transceiver displays the center frequency. Therefore, tune the transceiver to the specified FCC channel frequency when you operate in the CW mode.

Transceiver displayed frequency	FCC channel center frequency
5.33200 MHz	5.33200 MHz
5.34800 MHz	5.34800 MHz
5.35850 MHz	5.35850 MHz
5.37300 MHz	5.37300 MHz
5.40500 MHz	5.40500 MHz

Section 4 RECEIVING AND TRANSMITTING

Convenient for receiving.....	4-2	Operating RTTY (FSK).....	4-22
◇ All operating modes	4-2	◇ About the RTTY reverse mode	4-22
◇ SSB, CW, RTTY, and AM modes	4-2	◇ Twin Peak Filter	4-22
◇ SSB, AM, and FM modes	4-2	◇ Functions on the RTTY DECODE screen.....	4-23
◇ SSB-D, CW and RTTY modes.....	4-2	◇ Setting the decoder threshold level	4-23
◇ CW mode.....	4-2	◇ Transmitting an RTTY memory content	4-24
Convenient for transmitting.....	4-2	◇ Editing an RTTY memory.....	4-25
◇ SSB, AM and FM modes	4-2	◇ Turning ON the RTTY log	4-26
◇ SSB mode.....	4-2	◇ Viewing the RTTY log contents.....	4-26
◇ CW mode.....	4-2	◇ About the RTTY decode log set mode.....	4-27
Preamplifiers.....	4-3	◇ About the RTTY decode set mode.....	4-28
Attenuator.....	4-3	FM repeater operation.....	4-29
RIT function	4-3	◇ Setting the repeater tone frequency	4-29
◇ RIT monitor function.....	4-3	◇ Checking the repeater input signal	4-30
AGC function control	4-4	Tone squelch operation	4-30
◇ Selecting the AGC time constant		Data mode operation.....	4-31
preset value	4-4		
◇ Setting the AGC time constant.....	4-4		
Using the Twin PBT.....	4-5		
Selecting the IF filter.....	4-6		
Selecting the IF filter shape.....	4-6		
IP Plus function.....	4-7		
Noise Blanker	4-8		
◇ Adjusting the NB level and time	4-8		
Noise Reduction	4-9		
◇ Adjusting the Noise Reduction level	4-9		
Notch Filter	4-9		
◇ Auto Notch function	4-9		
◇ Manual Notch function	4-9		
VOX function	4-10		
◇ Adjusting the VOX function	4-10		
◇ Turning ON the VOX function	4-10		
ΔTX function.....	4-11		
◇ ΔTX monitor function	4-11		
Monitor function.....	4-11		
Setting the Speech Compressor.....	4-12		
Split frequency operation.....	4-13		
◇ Using the Quick Split function.....	4-13		
◇ Using the receive and transmit frequencies			
set to VFO A and VFO B	4-13		
Split Lock function	4-14		
Setting the transmit filter width	4-14		
Operating CW.....	4-14		
◇ Setting the CW pitch control	4-14		
◇ Setting the key speed	4-15		
◇ About the Break-in function	4-15		
◇ CW Auto Tuning function	4-16		
◇ About the CW Reverse mode	4-16		
◇ Electronic Keyer function	4-17		
◇ Monitoring the CW side tone	4-17		
◇ Sending from the Memory keyer (KEYER)..	4-18		
◇ Keyer memory edit menu (EDIT)	4-19		
◇ Contest number menu (001 SET).....	4-20		
◇ Keyer set menu (CW-KEY SET).....	4-21		

Convenient for receiving

◇ All operating modes

Preamplifiers and Attenuator (p. 4-3)

Use one of the Preamplifiers when receiving weak signals and use the Attenuator to prevent distortion when receiving strong signals.

Notch Filter (p. 4-9)

Automatically attenuates beat tones, tuning signals, and so on.

- In the SSB or AM mode:
Use the Auto notch or Manual notch.
- In the CW or RTTY mode:
Use the Manual notch.
- In the FM mode:
Use the Auto notch.

RX HPF/LPF (p. 12-3)

Sets the receive audio high-pass filter and low-pass filter cutoff frequency in 100 Hz steps.

MENU » **SET > Tone Control/TBW > RX**

◇ SSB, CW, RTTY, and AM modes

Noise Blanker (p. 4-8)

The Noise Blanker eliminates pulse-type noise.

Noise Reduction (p. 4-9)

The Noise Reduction function reduces random noise components and enhances desired signals that are buried in noise. The DSP (Digital Signal Processor) does the random noise reduction.

AGC (p. 4-4)

The AGC (Auto Gain Control) controls the receiver gain to produce a constant audio output level, even when the received signal strength greatly varies.

Twin PBT (p. 4-5)

To reject interference, the Twin PBT (Passband Tuning) electronically narrows the IF passband width by shifting the IF frequency slightly outside of the IF filter passband.

◇ SSB, AM, and FM modes

Receive Audio Tone Control (p. 12-3)

You can adjust the received audio bass and treble.

MENU » **SET > Tone Control/TBW > RX**

◇ SSB-D, CW, and RTTY modes

1/4 function (p. 3-5)

The dial speed is reduced to 1/4 of the normal speed, for finer tuning control.

◇ CW mode

Auto Tuning (p. 4-16)

The transceiver automatically tunes the desired signal within the ± 500 Hz range.

Convenient for transmitting

◇ SSB, AM, and FM modes

VOX function (p. 4-10)

The VOX (Voice-Operated Transmission) function switches between transmitting and receiving with your voice. This function provides hands-free operation.

Transmit Monitor (p. 4-11)

The Monitor function enables you to monitor your transmitted audio.

Audio Tone Control (p. 12-3)

You can adjust the transmit audio bass and treble.

MENU » **SET > Tone Control/TBW > TX**

◇ SSB mode

Speech compressor (p. 4-12)

The speech compressor increases average RF output power, improving signal strength and readability.

Transmitter Filter Width (p. 4-14)

You can select WIDE, MID, and NAR compression bandwidths.

MENU » **SET > Tone Control/TBW > TX**

◇ CW mode

Break-in function (p. 4-15)

You can use the Break-in function to automatically switch the transceiver between transmit and receive when keying. The IC-7300 is capable of Full Break-in and Semi Break-in mode.

Preamplifiers

The preamps amplify received signals in the receiver front end to improve the signal-to-noise ratio and sensitivity. A preamp is used when receiving weak signals.

① Each band memorizes the Preamplifier setting.

Push **[P.AMP/ATT]** (P.AMP).

① Each push changes between “P.AMP1,” “P.AMP2,” and OFF (no icon).



Displayed when the preamp is ON.
(Example: P.AMP1)

P.AMP1	Wide dynamic range preamplifier. It is most effective for the HF low bands.
P.AMP2	High-gain preamplifier. It is most effective for the 50 MHz bands.

NOTE: When you use the preamp while receiving strong signals, the signal may be distorted. In such a case, turn OFF the preamp.

Attenuator

The Attenuator prevents a desired signal from becoming distorted when a very strong signal is near the frequency, or when a very strong electric field, such as from a broadcasting station, is near your location.

① Each band memorizes the Attenuator setting.

Hold down **[P.AMP/ATT]** (ATT) for 1 second to turn ON the Attenuator.

① Pushing **[P.AMP/ATT]** turns OFF the Attenuator (no icon).



Displayed when the Attenuator is ON

RIT function

The RIT (Receive Increment Tuning) function compensates for differences in frequencies of other stations.

The function shifts the receive frequency up to ± 9.99 without shifting the transmit frequency.

1. Push **[RIT]**.

• The RIT function turns ON.

① When using the Fine Tuning function (p. 3-4), the RIT frequency is displayed in 4 digits, instead of 3.

① Pushing **[RIT]** again turns OFF the RIT function.

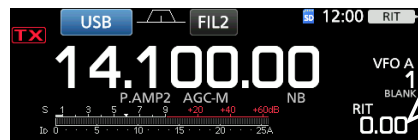

RIT frequency (3 digits)

2. Set the RIT frequency to match the receiving station's frequency.

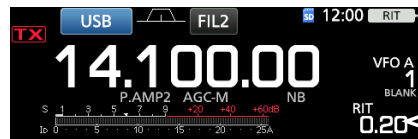

Rotate

Set RIT frequency.

① You can reset the RIT frequency to “0.00” by holding down **[CLEAR]** for 1 second.

① You can add the frequency shift to the operating frequency by holding down **[RIT]** for 1 second.

3. After communicating, push **[RIT]** to turn the RIT function OFF.

◇ RIT monitor function

When the RIT function is ON, you can directly monitor the operating frequency by holding down **[XFC]**.

① While monitoring, the RIT function is temporarily OFF.

① While monitoring, the settings for the Noise Reduction, Notch filter and Twin PBT are temporarily OFF.

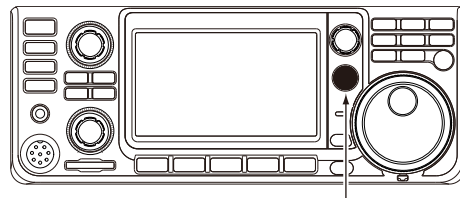

While holding down **[XFC]**.

AGC function control

The AGC (Automatic Gain Control) controls receiver gain to produce a constant audio output level, even when the received signal strength varies greatly.

◇ Selecting the AGC time constant preset value

The transceiver has 3 preset AGC settings for all modes except the FM mode. The time constants are FAST, MID and SLOW.

1. Select the operating mode.
(Example: SSB)
2. Push **FUNCTION**.
• Opens the FUNCTION screen.
3. Touch [AGC] to select the desired FAST, MID, or SLOW time constant.
①For the FM mode, the FAST time constant is fixed.



FUNCTION screen (SSB mode)

4. To close the FUNCTION screen, **EXIT**.

◇ Setting the AGC time constant

You can set the preset AGC time constant to a desired value.

1. Select the operating mode.
(Example: SSB)
2. Push **FUNCTION**.
• Opens the FUNCTION screen.
3. Touch [AGC] for 1 second.

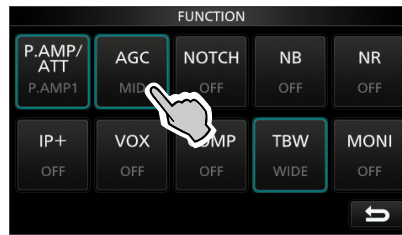

FUNCTION screen (SSB mode)

- Opens the AGC (SSB) screen.

4. Touch either FAST, MID, or SLOW to select the desired AGC time constant.
(Example: MID)



AGC (SSB) screen (SSB mode)

You can reset to the default setting by touching this key for 1 second.

5. Rotate **MAIN DIAL** to set the time constant.
①The adjustable time constants are described in the table below.
6. To close the AGC (SSB) screen, push **EXIT**.

• Selectable AGC Time constant (unit: seconds)

Mode	Default	Adjustable time constant
SSB	0.3 (FAST)	OFF, 0.1, 0.2, 0.3, 0.5, 0.8, 1.2, 1.6, 2.0, 2.5, 3.0, 4.0, 5.0 or 6.0
	2.0 (MID)	
	6.0 (SLOW)	
CW/RTTY	0.1 (FAST)	OFF, 0.1, 0.2, 0.3, 0.5, 0.8, 1.2, 1.6, 2.0, 2.5, 3.0, 4.0, 5.0 or 6.0
	0.5 (MID)	
	1.2 (SLOW)	
AM	3.0 (FAST)	OFF, 0.3, 0.5, 0.8, 1.2, 1.6, 2.0, 2.5, 3.0, 4.0, 5.0, 6.0, 7.0 or 8.0
	5.0 (MID)	
	7.0 (SLOW)	
FM	0.1 (FAST)	Fixed

NOTE: When you are receiving weak signals, and a strong signal is momentarily received, the AGC function quickly reduces the receiver gain. When that signal disappears, the transceiver may not receive the weak signal because of the AGC action. In that case, select FAST, or touch [AGC] for 1 second to open the AGC screen, and then select OFF the time constant setting.

Using the Twin PBT

SSB, CW, RTTY and AM modes

In general, the Twin PBT (Passband Tuning) electronically narrows the IF passband width by shifting the IF frequency to slightly outside of the IF filter passband, to reject interference. The IC-7300 uses DSP for the PBT function.

You can narrow the IF passband width by rotating both **(TWIN PBT CLR)** inner (PBT1) and outer (PBT2) to the opposite direction from each other.

① You can see the nearby signal using the Spectrum Scope (Section 5).

1. Rotate **(TWIN PBT CLR)** inner (PBT1) and outer (PBT2) to the opposite direction from each other.



① Information

- Match both the **(TWIN PBT CLR)** (inner) (PBT1) and outer (PBT2) filters before operating the Twin PBT.
- Rejects interference of both higher and lower passbands.
- If you rotate the control too much, the received audio may not be heard because the passband width is too narrow.
- Displays the passband width and shift value.
- A dot is displayed to the right of the passband width when you rotate **(TWIN PBT CLR)**.
- Hold down **(TWIN PBT CLR)** for 1 second to clear the PBT setting (the dot disappears).
- The PBT is adjustable in 50 Hz steps in the SSB, CW, and RTTY modes, and 200 Hz in the AM mode. In this case, the center shift value changes in 25 Hz steps in the SSB, CW, and RTTY modes, and 100 Hz in the AM mode.
- Rotating both the inner and outer controls to the same position shifts the IF left or right.

2. Touch the Filter icon for 1 second to display the current passband width and shift frequency.
 - Opens the FILTER screen.

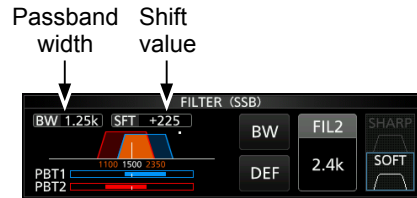

FILTER (SSB) screen (while operating Twin PBT)

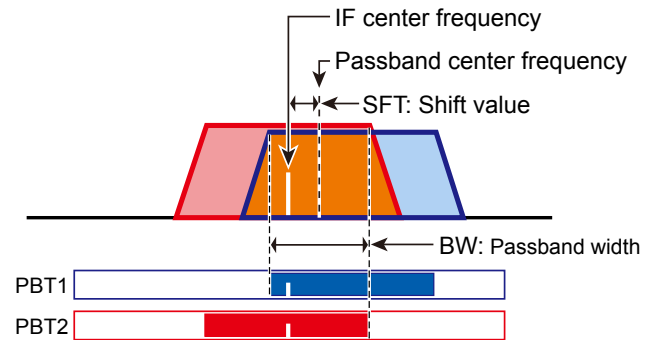

3. To close the FILTER screen, push **(EXIT)**.

NOTE: While rotating **(TWIN PBT CLR)**, you may hear noise. This comes from the DSP unit and does not indicate an equipment malfunction.

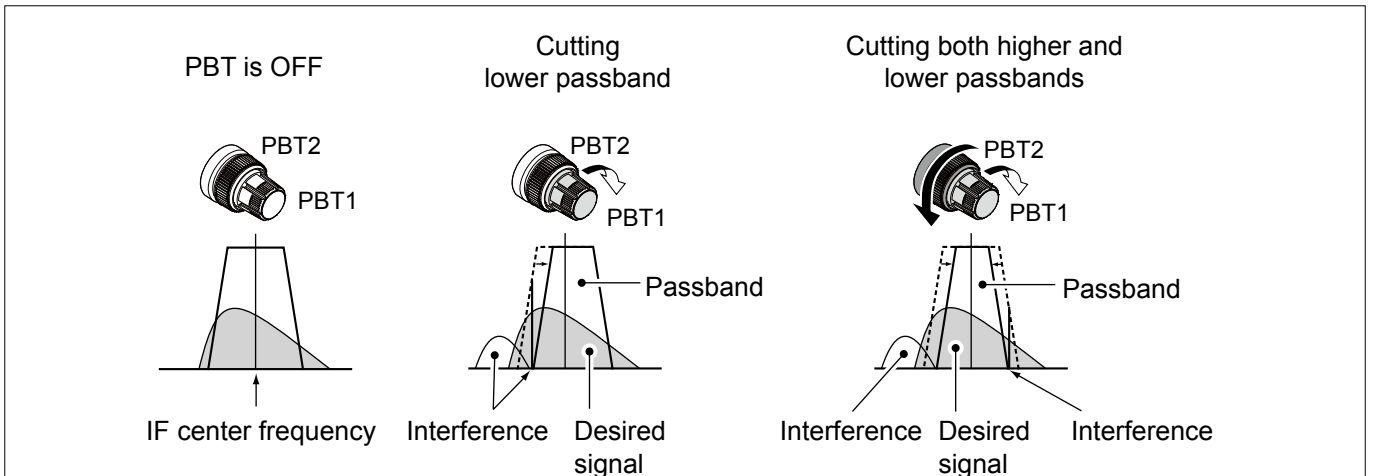

Selecting the IF filter

The transceiver has 3 IF filter passband widths for each mode, and you can select them on the FILTER screen. You can set the IF filter to wide (FIL 1), mid (FIL 2), or narrow (FIL 3).

1. Select the operating mode.
(Example: USB)
2. Touch the filter icon for 1 second.
• Opens the FILTER (SSB) screen.



3. Touch the filter icon more times to select FIL 1 (wide), FIL 2 (mid) or FIL 3 (narrow).
4. Touch [BW].
• Selects the passband width mode.
①When you change the passband width, the Twin PBT setting value is reset to the center position.



FILTER (SSB) screen (when FIL 2 is selected)

5. Rotate **(MAIN DIAL)** to adjust the passband width.
①You cannot change the passband width in the FM or FM-D mode.



Passband width mode

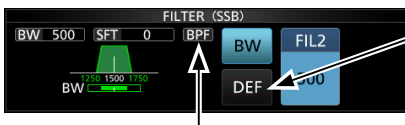

Touch [DEF] for 1 second to reset to default.

Displayed when a band width less than 500 Hz is selected in the SSB or CW mode.

6. Touch [BW].
• Cancels the passband width mode.
7. Repeat steps 2 to 6 to set the passband width for other modes except for the FM and FM-D.
8. To close the FILTER screen, push **(EXIT)**.

TIP: When you set the IF filter to FIL2 or FIL3 in the FM mode, the transceiver will transmit in the FM narrow mode.

Mode	IF filter	Selectable range (steps)
SSB	FIL 1 (3.0 kHz)	50Hz to 500Hz (50 Hz)/ 600Hz to 3.6kHz (100 Hz)
	FIL 2 (2.4 kHz)	
	FIL 3 (1.8 kHz)	
SSB-D	FIL 1 (3.0 kHz)	50Hz to 500Hz (50 Hz)/ 600Hz to 3.6kHz (100 Hz)
	FIL 2 (1.2 kHz)	
	FIL 3 (500 Hz)	
CW	FIL 1 (1.2 kHz)	50Hz to 500Hz (50 Hz)/ 600Hz to 3.6kHz (100 Hz)
	FIL 2 (500 Hz)	
	FIL 3 (250 Hz)	
RTTY	FIL 1 (2.4 kHz)	50Hz to 500Hz (50 Hz) 600Hz to 2.7kHz (100 Hz)
	FIL 2 (500 Hz)	
	FIL 3 (250 Hz)	
AM AM-D	FIL 1 (9.0 kHz)	200Hz to 10.0kHz (200 Hz)
	FIL 2 (6.0 kHz)	
	FIL 3 (3.0 kHz)	
FM FM-D	FIL 1 (15 kHz)	Fixed
	FIL 2 (10 kHz)	
	FIL 3 (7.0 kHz)	

Selecting the IF filter shape

You can independently set the DSP filter shape for operating modes to soft or sharp.

1. Set the operating mode to SSB, SSB-D, or CW.
(Example: USB)
2. Touch the filter icon for 1 second.
• Opens the FILTER screen.



3. Touch the filter icon several times to select FIL1 (wide), FIL2 (mid), or FIL3 (narrow).
4. Touch [SHARP] or [SOFT].



When [SOFT] is selected

5. To close the FILTER screen, push **(EXIT)**.

4 RECEIVING AND TRANSMITTING

Selecting the IF filter shape

• SHARP

This selection is to emphasize the passband width of the filter. The filter has an almost ideal shape factor. Signals of the out of passband are extremely filtered out and it gives you better audio quality.

• SOFT

The filter shoulders are roundly formed as in analog filters. This decreases noise components in the high and low frequencies of the filter passband and increases the S/N of the target signal. These characteristics play an effective role in picking up very weak signals in the 50 MHz band, for example. The shape factor is kept, and the sharpness of the bandpass is excellent.

IP Plus function

The IP Plus function improves the Intermodulation Distortion (IMD) quality by exerting the direct sampling system performance.

This function optimizes the Analog/Digital Converter (ADC) against the distortion when you receive a strong input signal. It also improves the Third-order Intercept Point (IP3) while minimizing the reduction of the receive sensitivity.

1. Push **FUNCTION**.
 - The FUNCTION screen is displayed.
2. Touch **[IP+]**.
 - ① Touch **[IP+]** to turn the IP Plus function ON or OFF.
 - ① Select ON to prioritize the IP quality, and select OFF to prioritize the receive sensitivity.



3. To close the FUNCTION screen, push **EXIT**.
 - "IP+" is displayed when ON is selected.



Noise Blanker

The Noise blanker eliminates pulse-type noise, such as the noise from car ignitions. The Noise blanker cannot be used in the FM mode.

Push **[NB]** to turn the Noise Blanker ON or OFF.



NOTE: When using the Noise Blanker, received signals may be distorted if they are excessively strong or the noise is other than a pulse type. In that case, turn OFF the Noise Blanker, or shallow the DEPTH on the NB menu. See the description below for details.

◇ **Adjusting the NB level and time**
To deal with various type of noise, you can adjust the attenuation level and noise width in the NB menu.

1. Hold down **[NB]** for 1 second.
 - Turns ON the Noise Blanker and opens the NB menu.
2. Touch the adjusting item.
(Example: DEPTH)

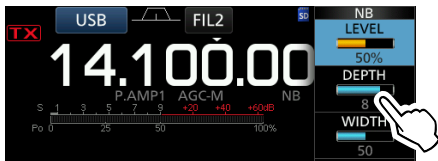

3. Adjust the level.
(Example: 8)



LEVEL (Default: 50%)

Adjust the level where the Noise Blanker activates between 0 and 100%.

DEPTH (Default: 8)

Adjust the noise attenuation level to between 1 and 10.

WIDTH (Default: 50)

Adjust the blanking duration time to between 1 and 100.

Noise Blanker OFF

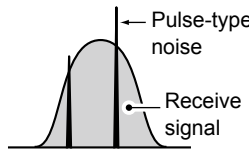

Noise Blanker ON

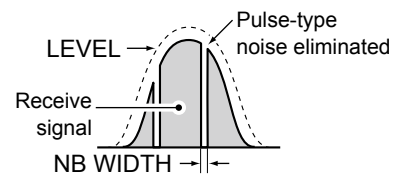

Noise Blanker ON
(Not enough DEPTH)

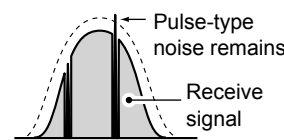

Noise Blanker ON
(WIDTH set too long)

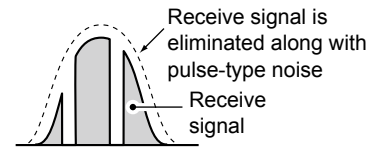

Noise Reduction

The Noise Reduction function reduces random noise components and enhances desired signals that are buried in noise. The Noise Reduction function uses the DSP circuit.

Push **[NR]** to turn the Noise Reduction function ON or OFF.



Adjusting the Noise Reduction level

Adjust the Noise Reduction level to where noise is reduced and the received signal is not distorted.

- Hold down **[NR]** for 1 second.
 - Turns ON the Noise Reduction function and opens the NR menu.
- Adjust the Noise Reduction level to between 0 and 15.
 - Adjust to a higher level to increase the reduction level, and a lower level to decrease it.



Noise Reduction OFF
NR level 0

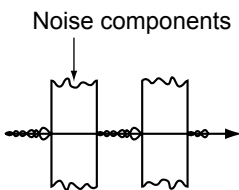

Noise Reduction ON
NR level 4

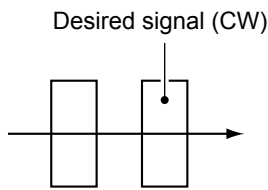

Notch Filter

The IC-7300 has Auto Notch and Manual Notch functions.

Auto Notch: Used in the SSB, AM, and FM modes.
Manual Notch: Used in the SSB, CW, RTTY, and AM modes.

Auto Notch function

Auto Notch automatically filters out beat tones, tuning signals and so on.

Push **[NOTCH]** until "AN (Auto Notch)" is displayed.
Pushing **[NOTCH]** changes between "AN (Auto Notch)," "MN (Manual Notch)" and OFF.



Manual Notch function

The Manual Notch filters out beat tones, tuning signals and so on by adjusting a frequency in the NOTCH menu.

- Hold down **[NOTCH]** for 1 second to display the NOTCH menu.
 - The Manual Notch is automatically selected and "MN" is displayed.
 - Pushing **[WIDTH]** sets the Manual Notch filter width to "WIDE," "MID," or "NAR."
- Slowly adjust the POSITION to manually attenuate the frequency.

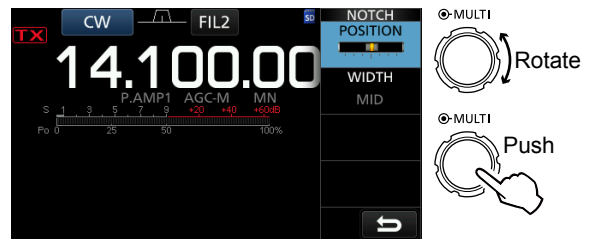

NOTE: While adjusting, noise may be heard. This comes from the DSP unit and does not indicate an equipment malfunction.

VOX function

The VOX (Voice-Operated Transmission) function switches between transmit and receive with your voice. This function enables a hands-free operation.

◇ Adjusting the VOX function

Before using the VOX function, adjust the following items.

- VOX GAIN
- ANTI VOX
- DELAY
- VOICE DELAY

1. Hold down **VOX/BK-IN** for 1 second.
 - Opens the VOX menu.
2. Touch the adjusting item.
(Example: ANTI VOX)

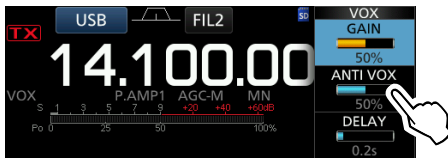

3. Adjust the selected item.
 - ① Adjust to the point where the transceiver does not switch to transmit due to the sound from the speaker or other devices.
 - ② Touching VOICE DELAY selects “SHORT,” “MID,” “LONG,” or “OFF.”



VOX GAIN (Default: 50%)

Adjust the transmit/receive switching threshold level to between 0% and 100% for VOX operation. Higher values make the VOX function more sensitive to your voice.

ANTI VOX (Default: 50%)

Adjust the ANTI VOX level to between 0% and 100% to prevent unwanted VOX activation from the speaker or other sounds. Higher values make the VOX function less sensitive.

DELAY (Default: 0.2s)

Adjust the DELAY to between 0 and 2.0 seconds, for a convenient interval for normal pauses in speech before returning to receive.

VOICE DELAY (Default: OFF)

Set the VOICE DELAY to prevent cutting off your first word or words when switching to transmit. Select “SHORT,” “MID,” “LONG,” or OFF.

◇ Turning ON the VOX function

1. Set the operating mode to SSB, AM, or FM.
(Example: USB)
2. Push **VOX/BK-IN** to turn ON the VOX function.
 - ① Pushing **VOX/BK-IN** again turns OFF the VOX function.



ΔTX function

The ΔTX function shifts the transmit frequency up to ±9.99 kHz without shifting the receive frequency.

1. Push **[ΔTX]**.
 - The ΔTX function turns ON.
 - ① Pushing **[ΔTX]** turns the ΔTX function ON or OFF.
 - ① While using the Fine Tuning function (p. 3-4), the ΔTX frequency is displayed in 4 digits, instead of 3.

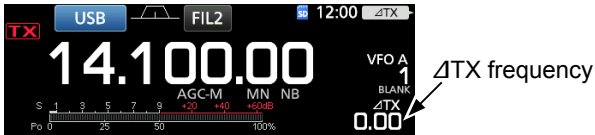

2. Set the ΔTX frequency to match the receiving station's frequency.

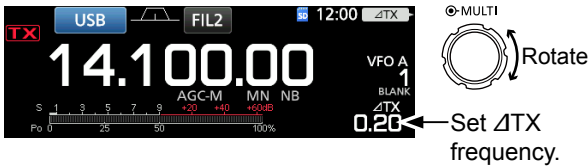

- ① To reset the ΔTX frequency to "0.00," hold down **[CLEAR]** for 1 second.
 - ① You can add the frequency shift to the operating frequency by holding down **[ΔTX]** for 1 second.
3. After communicating, push **[ΔTX]** to turn the ΔTX function OFF.

◇ ΔTX monitor function

When the ΔTX function is ON, you can directly monitor the operating frequency by holding down **[XFC]**.

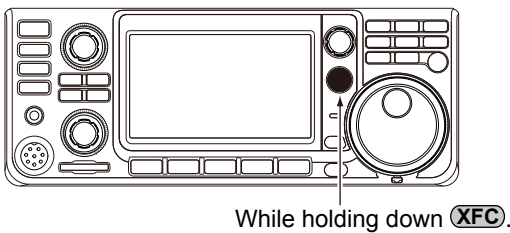

Monitor function

The Monitor function enables you to monitor your transmit audio. Use this function to check the voice characteristics while adjusting transmit audio parameters.

① You can hear the CW sidetone regardless of the Monitor function setting.

1. Select the mode that you want to monitor. (Example: USB)
2. Push **[FUNCTION]**.
 - Opens the FUNCTION screen.
3. Touch **[MONI]** to turn ON the Monitor function.
 - ① Touching **[MONI]** turns the Monitor function ON or OFF.



FUNCTION screen (USB mode)

4. Touch **[MONI]** for 1 second.



5. Adjust MONITOR to the clearest audio output between 0% and 100%, while speaking at your normal voice level.

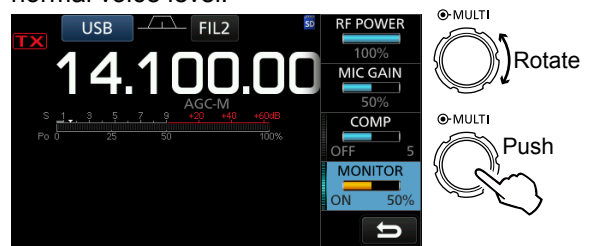

NOTE: When using the VOICE DELAY (p. 4-10), turn OFF the Monitor function. Otherwise, the transmitted audio will echo.

Setting the Speech Compressor

SSB mode

The Speech Compressor increases the average RF output power, improving readability at the receiving station. This function compresses the transmitter audio input to increase the average audio output level.

① The function is effective for long-distance communication, or when propagation conditions are poor.

1. Select the SSB mode.
(Example: USB)
2. Push **[FUNCTION]**.
• Opens the FUNCTION screen.
3. Be sure that the Speech Compressor is OFF.
① If the Speech Compressor is ON, touch **[COMP]** to turn it OFF.

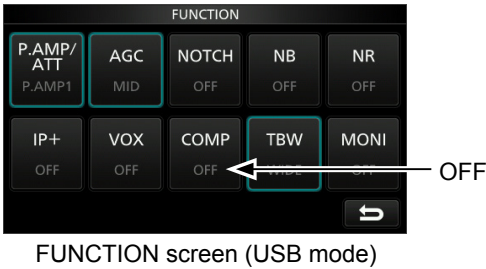

4. Touch **[EXIT]** to close the FUNCTION screen.
5. Touch the Multi-function meter to display the ALC meter.
① Touching the Multi-function meter sets the meter to Po, SWR, ALC, COMP, Vd or Id.



6. Adjust the MIC GAIN (p. 3-11) to where the ALC meter reads within the 30 to 50% range of the ALC zone.
7. Touch the Multi-function meter again to display the COMP meter.
8. Push **[FUNCTION]**.
• Opens the FUNCTION screen.
9. Touch **[COMP]** to turn it ON.

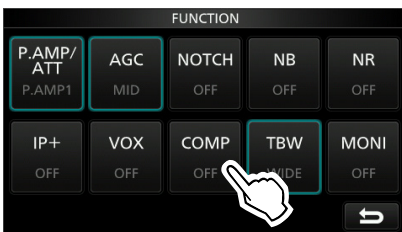

10. Touch **[COMP]** for 1 second.



11. While speaking into the microphone at your normal voice level, adjust the Speech Compressor level to where the COMP meter reads within the COMP zone (10 to 20 dB range).
① When the COMP meter peaks exceed the COMP zone, your transmitted voice may be distorted.

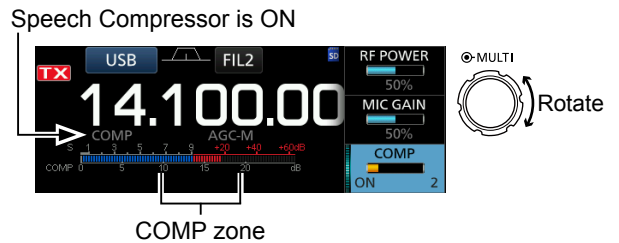



Split frequency operation

Split frequency operation enables you to transmit and receive on different frequencies in the same or different bands.

There are 2 ways to use the Split frequency operation.

- Use the Quick Split function
- Use the receive and transmit frequencies set to VFO A and VFO B.

Another station		My station	
Transmit frequency	USB mode 21.29000 MHz	VFO A Receive frequency	
Receive frequency	USB mode 21.31000 MHz	VFO B Transmit frequency	

◇ Using the Quick Split function

The Quick Split function enables you to automatically equalize the frequency and mode of VFOs to the displayed VFO, and activate the Split function.

1. Set VFO A's receive frequency and operating mode.
(Example: 21.29000 MHz in the USB mode)
2. Hold down **[SPLIT]** for 1 second.
 - The Quick Split function is turned ON and the VFO A settings are set to VFO B.
 - The VFO B frequency is displayed in the bottom right corner of the main screen.

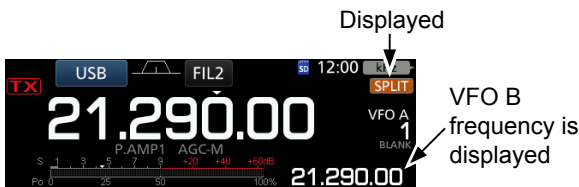

3. While holding down **[XFC]**, set the operating frequency offset between transmit and receive.



The offset between transmit and receive while holding down **[XFC]**.

◇ Using the receive and transmit frequencies set to VFO A and VFO B

1. Set VFO A's receive frequency and operating mode.
(Example: 21.29000 MHz in the USB mode)

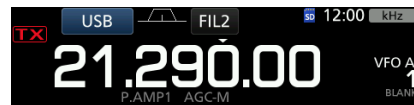

2. Push **[A/B]** to select VFO B, and then set the receive frequency and the operating mode.
(Example: 21.31000 MHz in the USB mode)

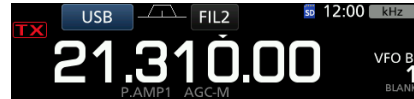

3. Push **[SPLIT]** to turn ON the Split function.
① Pushing **[SPLIT]** turns the Split function ON or OFF.

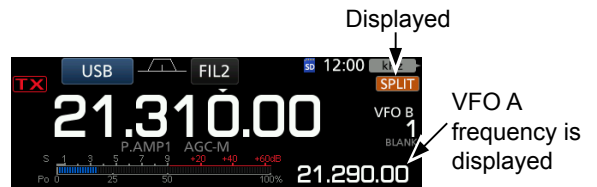

4. Push **[A/B]** to return to VFO A.
① The Split frequency operation is ready.



Split Lock function

The Split Lock function is convenient for changing only the transmit frequency but not changing the receive frequency.

1. Turn ON the Split Lock function.
MENU » **SET > Function > SPLIT > SPLIT LOCK**
2. Turn ON the Split function.
3. Hold down **[SPEECH]** for 1 second to turn ON the Dial Lock function.
4. While holding down **[XFC]**, set the transmit frequency.



Setting the transmit filter width

The transmit filter width for the SSB and SSB-D mode can be set. Only for the SSB mode, WIDE (wide), MID (middle), or NAR (narrow) can be selected.

① The filter can be independently set on the speech compressor function is ON or OFF.

To change the filter width in the SSB mode:

1. Set the operating mode to USB or LSB mode.
2. Push **[FUNCTION]**.
 • Opens the FUNCTION screen.
3. Touch **[TBW]**.
 ① Touching **[TBW]** sets the filter width to WIDE, MID, or NAR.

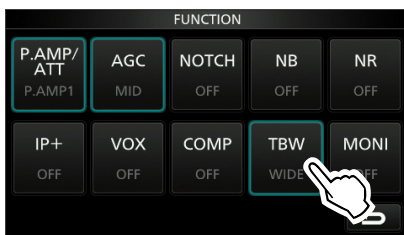

FUNCTION screen (SSB mode)

The transmit filter widths are set to the following values by default.

- SSB (WIDE): 100 Hz to 2900 Hz
- SSB (MID): 300 Hz to 2700 Hz
- SSB (NAR): 500 Hz to 2500 Hz
- SSB-D: 300 Hz to 2700 Hz

① You can change the filter width values in the following settings. (p. 12-3)

MENU » **SET > Tone Control/TBW > TX > SSB > TBW (WIDE)**

MENU » **SET > Tone Control/TBW > TX > SSB > TBW (MID)**

MENU » **SET > Tone Control/TBW > TX > SSB > TBW (NAR)**

MENU » **SET > Tone Control/TBW > TX > SSB-D > TBW**

Operating CW

◇ Setting the CW pitch control

You can set the received CW audio pitch and the CW side tone to suit your preference without changing the operating frequency.

1. Select the CW mode.
2. Display the Multi-function menu.

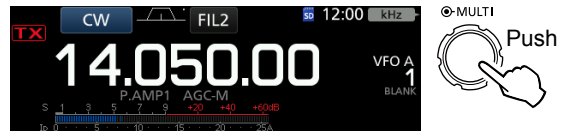

3. Touch **[CW PITCH]**.

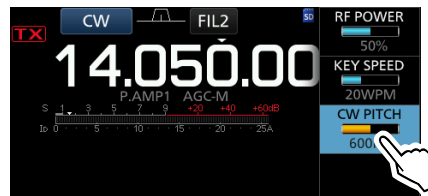

4. Set the CW pitch to between 300 and 900 Hz



4 RECEIVING AND TRANSMITTING

Operating CW (Continued)

◇ Setting the key speed

You can set the key speed of the internal electric keyer.

1. Select the CW mode.
2. Display the Multi-function menu.

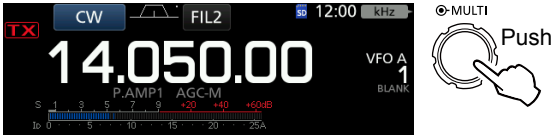

3. Touch [KEY SPEED].



4. Set the key speed to between 6 and 48 Words Per Minute (WPM).



◇ About the Break-in function

Use the Break-in function in the CW mode to automatically switch between transmit and receive when keying. The IC-7300 is capable of Semi Break-in and Full break-in modes.

TIP: The key type is set to “Paddle” by default. You can select the keyer type on the CW-KEY SET screen. (p. 4-21)

Semi Break-in mode

In the Semi Break-in mode, the transceiver transmits when keying, and then automatically returns to receive after a preset time after you stop keying.

1. Select the CW mode.
2. Push **VOX/BK-IN** to display “BKIN.”
 ① Pushing **VOX/BK-IN** selects “BKIN (Semi Break-in),” “F-BKIN (Full Break-in),” or OFF (no indication).

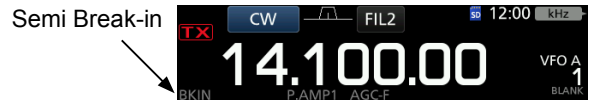

3. To adjust the Break-in delay time, hold down **VOX/BK-IN** for 1 second.
 • Opens the BKIN menu.
4. Set to where the transceiver does not return to receive while keying.



- ① When you are using a paddle, push **MULTI** to display the Multi-function menu, and then adjust the KEY SPEED while operating the paddle.

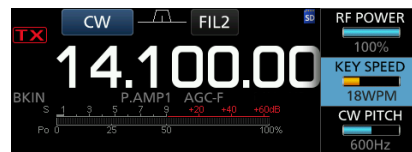

5. To close the BKIN menu, push **EXIT**.

4 RECEIVING AND TRANSMITTING

Operating CW

◇ About the Break-in function

Full Break-in mode

In the Full Break-in mode, the transceiver automatically transmits while keying down, and then immediately returns to receive after keying up.

1. Select the CW mode.
2. Push **VOX/BK-IN** until "F-BKIN" is displayed.
① Pushing **VOX/BK-IN** selects "BKIN (Semi Break-in)," "F-BKIN (Full Break-in)," or OFF (no indication).

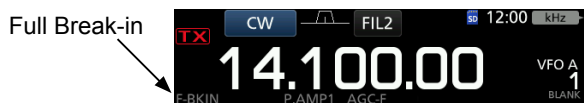

3. Using a straight key or paddle.
① In the Full break-in mode, the transceiver automatically returns to receive without a preset break-in delay time after you stop keying. The transceiver receives while keying up.

◇ CW Auto Tuning function

You can tune in a CW signal you are receiving using the Auto Tuning function. You can automatically tune by pushing **AUTO TUNE**. This function is active in only the CW mode.

- ① While using the RIT, the RIT frequency is automatically tuned by this function.



NOTE: When receiving a weak signal, or receiving a signal with interference, the Auto Tuning function may tune the receiver to an undesired signal, or may not start to tune. In such case, a warning beep sounds.

◇ About the CW Reverse mode

The CW-R (CW Reverse) mode reverses the received Beat Frequency Oscillator (BFO) to receive CW signals.

Use when interfering signals are near the desired signal and you want to use the CW-R to reduce interference.

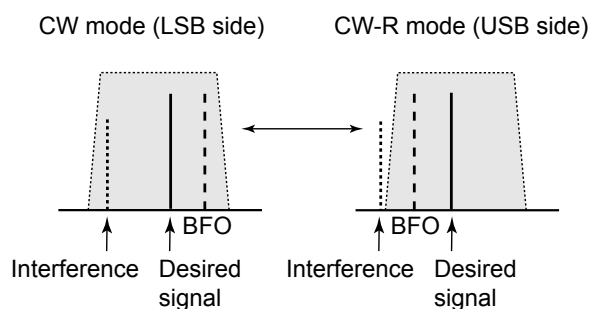

TIP: Reversing the carrier point

The carrier point of the CW mode is LSB by default. You can change it to USB in the "CW Normal Side" item of the OTHERS set screen. (p. 12-6)

MENU » **SET > Function > CW Normal Side**

- ① When this setting is set to "USB," the CW and CW-R modes are reversed.

4 RECEIVING AND TRANSMITTING

Operating CW

◇ Electronic Keyer function

You can set the Memory Keyer function settings, paddle polarity settings, and so on of the Electronic Keyer.

1. Open the KEYER screen in the CW mode.

MENU » **KEYER**

① You can select [KEYER] on the MENU screen only in the CW mode.

2. Touch [EDIT/SET].

• Opens the EDIT/SET screen.



KEYER screen

3. Select the desired item to set.



EDIT/SET screen

4. To close the KEYER screen, push **EXIT** several times.

Keyer memory edit menu (p. 4-19)

You can edit the Keyer memories.

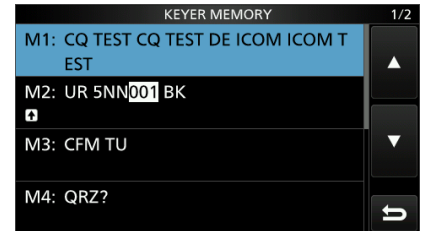

Contest number menu (p. 4-20)

You can set the number style, count up trigger, and present number.

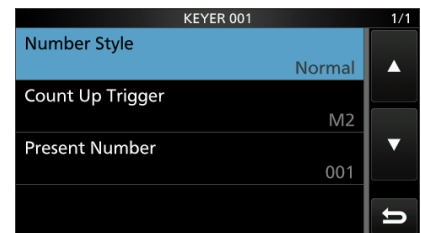

Key set menu (p. 4-21)

You can set the memory keyer repeat time, dot/dash ratio, paddle polarity, key type, and so on.

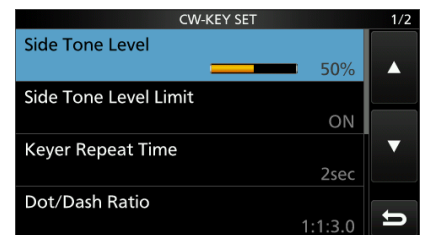

◇ Monitoring the CW side tone

When the transceiver is in standby and the Break-In function is OFF, you can listen to the CW side tone without actually transmitting.

① Information

- This enables you to match your transmit frequency exactly to another station's by matching the audio tone.
- You can also use the CW side tone (make sure the Break-in function is OFF (p. 4-15)) to practice CW sending.
- You can adjust the CW side tone level in "Side Tone Level."

MENU » **KEYER > EDIT/SET > CW-KEY SET > Side Tone Level**

4 RECEIVING AND TRANSMITTING

Operating CW

◇ Sending from the Memory keyer (KEYER)

You can send preset characters using the Memory keyer function.

Sending

1. Open the KEYER screen in the CW mode.

MENU » **KEYER**

2. Push **TRANSMIT**.
 - The TX status indicator lights red.
 - ① If you want to automatically switch between transmit and receive, turn the Break-in function ON. (p. 4-15)
3. Touch a desired memory keyer between [M1] and [M4].
 - The touched keyer contents are sent.
4. To stop sending, push **EXIT**.



Sending contents

KEYER screen while sending
(Example: sending M1)



Displayed

KEYER screen while sending
(Example: Repeatedly sending M1)

Key	Action	
M1~M8	Touch	Sends the Memory keyer contents
	Touch for 1 second	<p>↻ is displayed and repeatedly sends the Memory keyer contents.</p> <p>① You can change the repeat interval setting in "Keyer Repeat Time" in the CW-KEY SET menu. (p. 4-21)</p>
-1 001	<p>Reduces the contest number counter by 1 (001).</p> <p>① You can change or reset the number in "Present Number" in the KEYER 001 menu. (p. 4-20)</p>	
EDIT/SET	Touch to display the EDIT/SET screen.	

Count up trigger

The count up trigger enables the serial number to be automatically increased after each complete serial number exchange is sent. (Default: M2)



Count up trigger icon

Present number counter

- ① ↕ is displayed on the Memory keyer set to the count up trigger.
- ① You can change the count up trigger setting in the KEYER 001 menu. (Default: M2) (p. 4-20)

Preset Memory keyer contents

Memory keyer	Contents
M1	CQ TEST CQ TEST DE ICOM ICOM TEST
M2	UR 5NN 001 BK
M3	CFM TU
M4	QRZ?

- ① "001" is the CW contest number.
- ① If you want to set the Count up trigger to different keyer, delete "*" (asterisk) from the Memory keyer M2. See "Keyer memory edit menu (EDIT)" (p. 4-19) for details.

TIP: When you are using an external keypad, you can send the preset contents without opening the KEYER screen. See page 18-3 for details.

4 RECEIVING AND TRANSMITTING

Operating CW

◇ Keyer memory edit menu (EDIT)

Edit the Memory keyer contents in the EDIT menu.

① You can use up to a total of 8 Memory keyers (M1 to M8), and you can enter up to 70 characters in each memory.

Editing

(Example: Entering “QSL TU DE JA3YUA TEST” to M3)

1. Open the KEYSER MEMORY screen in the CW mode.

MENU » **KEYER > EDIT/SET > EDIT**

2. Touch “CFM TU” for 1 second.



3. Touch “Edit.”

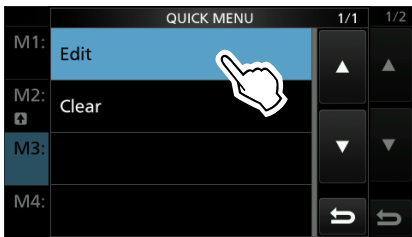

4. Touch [CLR] until the preset contents are cleared.

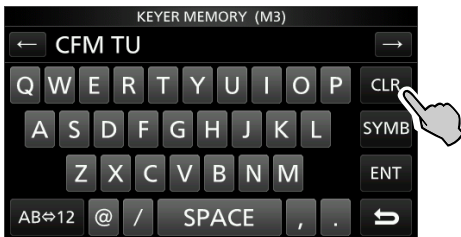

5. Enter “QSL TU DE JA3YUA TEST,” and then touch [ENT] to save.

① See “Keyboard entering and editing” (p. 1-9) for details.

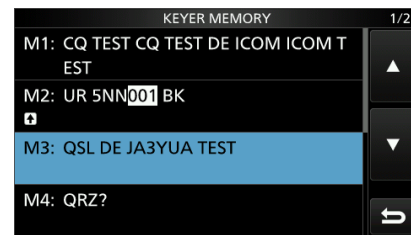
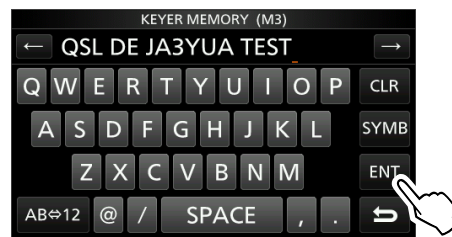

6. To close the KEYSER screen, push **EXIT** several times.

Selectable characters	
Alphabets	ABCDEFGHIJKLMNOPQRSTUVWXYZ
Symbols	/ ? ^ . , @ *
Numbers	1234567890

About the symbols

- Enter “^” to send a string of characters with no intercharacter space. Put “^” before a text string such as ^AR, and the string “ar” is sent with no space.
- Enter “*” (asterisk) to insert the CW contest number. The number automatically advances by 1. You can use this for only 1 Memory keyer at a time. “*” is used in Memory keyer M2 by default.

4 RECEIVING AND TRANSMITTING

Operating CW

◇ Contest number menu (001 SET)

You can set the number style, count up trigger and preset number.

Setting

1. Open the KEYER 001 menu in the CW mode.

MENU » **KEYER > EDIT/SET > 001 SET**

2. Select the setting item.
(Example: Number Style)

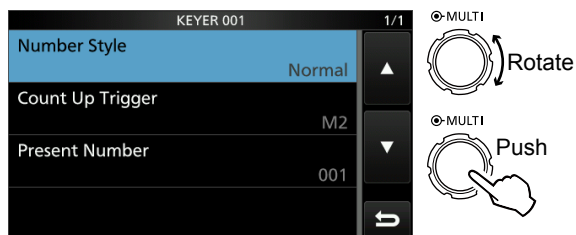

KEYER 001 menu

3. Select the desired setting option.



- Returns to the KEYER 001 menu.

4. To close the “Number Style” screen, push **EXIT** several times.

TIP: How to reset to the default setting

Touching the item or its option for 1 second displays the Quick menu, and then touch “Default” to reset to the default setting.

Number Style (Default: Normal)

Set the numbering system used for contest (serial) numbers— normal or short morse numbers.

- Select Normal, 190→ANO, 190→ANT, 90→NO or 90→NT.

Count Up Trigger (Default: Normal)

Select which of the 8 memories will contain the contest serial number exchange.

- Select between M1 and M8.

Present Number (Default: 001)

Set the current number for the Count Up Trigger.

- Set to between 001 and 9999.

4 RECEIVING AND TRANSMITTING

Operating CW

◇ Keyer set menu (CW-KEY SET)

In this menu, you can set the memory keyer repeat time, dash weight, paddle specifications, key type, and so on.

Setting example

1. Open the CW-KEY SET menu in the CW mode.

MENU » **KEYER > EDIT/SET > CW-KEY SET**

2. Select the setting item.
(Example: Side Tone Level)

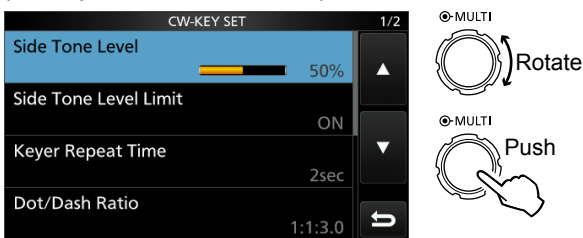

CW-KEY SET menu

3. Adjust the Side Tone Level.
(Example: 80%)

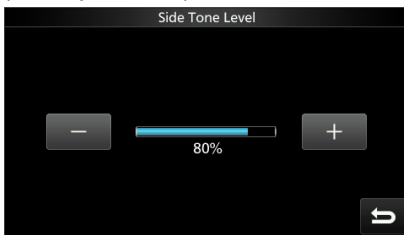

4. To close the KEYER screen, push **EXIT** several times.

Side Tone Level (Default: 50%)

Adjust the CW side tone output level.

- Adjust to between 0 and 100%.

Side Tone Level Limit (Default: ON)

Turn the CW side tone level limit ON or OFF. This disables the CW side tone when you rotate **(AF→RF/SQL)** (inner) above the side tone level.

Keyer Repeat time (Default: 2sec)

Set the time between Memory keyer transmissions.

- Set to between 1 and 60 seconds.

Dot/Dash Ratio (Default: 1:1:3.0)

Set the dot/dash ratio.

- Set to between 1:1:2.8 to 1:1:4.5 in 0.1 steps.

Keying weight example: Morse code “K”

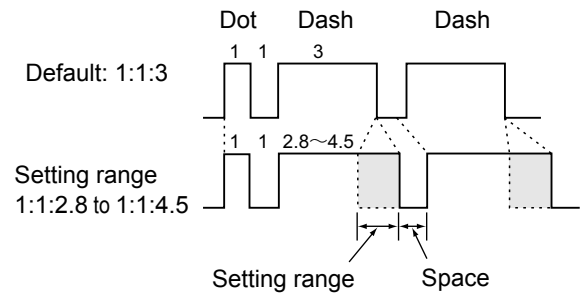

Rise Time (Default: 4ms)

Set the rise time of the transmitted CW envelope.

- Set to 2, 4, 6 or 8 milliseconds.

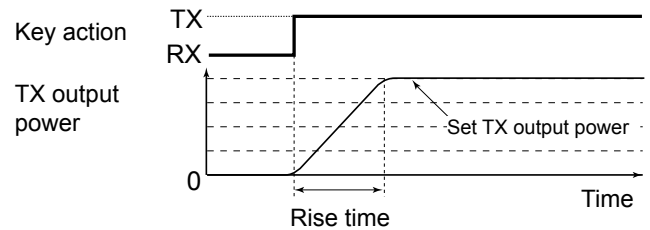

Paddle Polarity (Default: Normal)

Set the paddle dot-dash polarity to Normal or Reverse.

- Normal: Right = dash, Left = dot
- Reverse: Right = dot, Left = dash

Key Type (Default: Paddle)

Set the key type for the [KEY] connector on the rear panel.

- Set to Straight, Bug or Paddle.

MIC Up/Down Keyer (Default: OFF)

Set the microphone [UP]/[DN] keys to use as a CW key.

- ON: Use the [UP]/[DN] keys as a CW key.
- OFF: Do not use the [UP]/[DN] keys as a CW key.

- ① The [UP]/[DN] keys do not work as a “squeeze key.”
- ① When “ON” is selected, you cannot change the frequency and the Memory channels using the [UP]/[DN] keys.

TIP: How to reset to the default setting

Touching the item or its option for 1 second displays the Quick menu, and then touch “Default” to reset to the default setting.

Operating RTTY (FSK)

With the built-in RTTY decoder and the contents set in the RTTY TX memory, you can operate the basic RTTY operation without using an external device.

① If you are using PSK software, refer to the software manual.

1. Select the RTTY mode.
2. Open the RTTY DECODE screen.

MENU » **DECODE**

① You can select [DECODE] on the MENU screen only while in the RTTY mode.



RTTY DECODE screen

3. Rotate **MAIN DIAL** to tune the desired signal.

Information

- Aim for a symmetrical wave form, and be sure the peak points align with the mark (2125 Hz) and shift (170 Hz) frequency lines in the FFT scope.
- The S-meter displays the received signal strength, when a signal is received.
- If you cannot decode correctly, try in the RTTY-R mode.
- Tune to where both “◀” and “▶” are displayed in the tuning indicator.

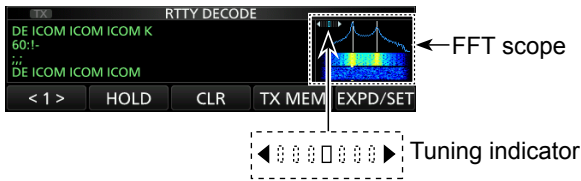

4. Transmit the RTTY memory.

- The TX status indicator lights red and the Po meter swings.



Contents being transmitted are displayed.
(Example: transmitting the RT1's TX memory)

About the RTTY reverse mode

If you are receiving an RTTY signal but cannot decode correctly, try in the RTTY-R (reverse) mode.

Select the RTTY-R mode by touching [RTTY] on the MODE screen.

① Touching [RTTY] toggles between the RTTY mode and the RTTY-R mode.

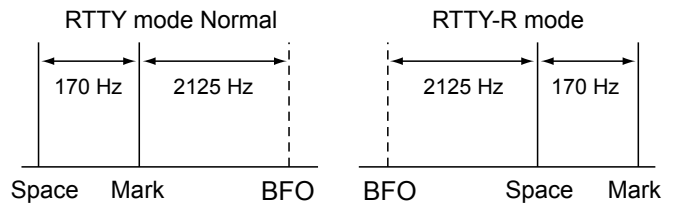

Twin Peak Filter

The Twin Peak Filter (TPF) changes the audio frequency response by boosting the mark and space frequencies for better reception of RTTY signals, or for decoding the external AF output on a PC.

1. While in the RTTY mode, display the Multi-function menu.

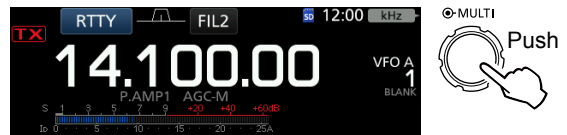

2. Touch [TPF].
① Touching [TPF] turns the function ON or OFF.

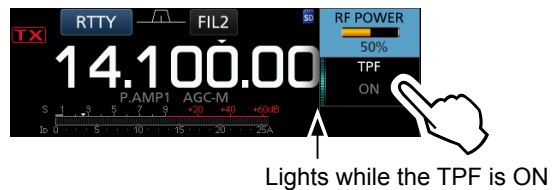

Lights while the TPF is ON

3. To close the Multi-function menu, push **EXIT**.

NOTE: When you are using the Twin Peak Filter, the received audio output may increase. This is not a malfunction.

4 RECEIVING AND TRANSMITTING

Operating RTTY (FSK)

◆ Functions on the RTTY DECODE screen

Open the RTTY DECODE screen in the RTTY mode.

MENU » **DECODE**

TIP: Touching [EXPD/SET] toggles between the Normal screen and Expanded screen.



Normal screen

RTTY DECODE screen

When tuned to an RTTY signal, the decoded characters are displayed.



Expanded screen

RTTY DECODE screen

Key	Action	
<1>	Selects the function menu.	
<2>	Selects the function menu.	
HOLD	Turns the Hold function ON or OFF. ① "[HOLD]" is displayed, and the RTTY DECODE screen stops.	
CLR	Touch for 1 second to clear the displayed characters. • While the Hold function is ON, this clears the characters and cancels the Hold function.	
TX MEM	Opens the RTTY MEMORY screen.	
LOG	Opens the RTTY DECODE LOG screen. • Starts/Stops logging, selects the file type or the time stamp.	
LOG VIEW	Opens the RTTY DECODE LOG VIEW screen. • You can check the saved RTTY log files.	
ADJ	Opens the THRESHOLD screen. • You can set the threshold level.	
EXPD/SET	Touch	Selects the Expanded or Normal screen.
	Touch for 1 second	Opens the RTTY DECODE SET screen.

◆ Setting the decoder threshold level

Adjusting the RTTY decoder threshold level prevents characters been decoded from noise, even though you have not received an RTTY signal.

1. Open the RTTY DECODE screen.

MENU » **DECODE**

2. Touch [<1>].



RTTY DECODE screen

- The function menu <2> is displayed.

3. Touch [ADJ].

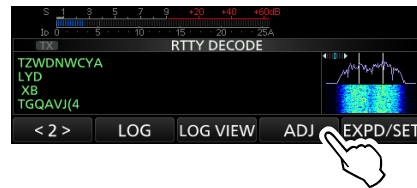

- The THRESHOLD setting screen is displayed.

4. Checking the RTTY DECODE, rotate **MAIN DIAL** to adjust the threshold level to where the characters are not displayed from noise.

① If the threshold level adjusted is too high, you cannot receive weak signals.

① Touch [DEF] for 1 second to reset to the default setting.



5. To close the THRESHOLD setting screen, touch [ADJ].

4 RECEIVING AND TRANSMITTING

Operating RTTY (FSK)

◇ Transmitting an RTTY memory content

You can transmit the preset characters on the RTTY MEMORY screen.

① You can edit the characters by touching [EDIT] on the RTTY MEMORY screen.

1. Open the RTTY DECODE screen in the RTTY mode.

MENU » **DECODE**

2. Touch [TX MEM].



RTTY DECODE screen

- Opens the RTTY MEMORY screen.

3. Touch the desired RTTY memory between [RT1] and [RT8] to transmit.

(Example: RT1)

① To cancel the transmission and to return to the RTTY DECODE screen, push **EXIT**.



RTTY MEMORY screen

- The TX status indicator lights red and the Po meter swings.

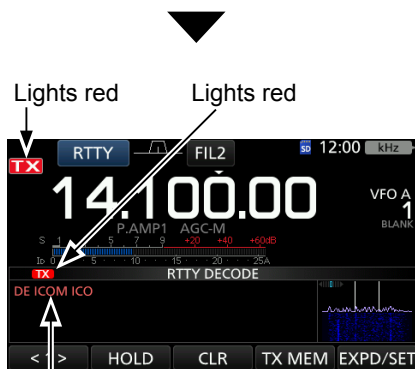

Transmitting contents are displayed.
(Example: RT1)

Memory	Preset characters by default
RT1	↓ DE ICOM ICOM K ↓
RT2	↓ DE ICOM ICOM ICOM K ↓
RT3	↓ QSL UR 599-599 BK ↓
RT4	↓ QSL DE ICOM ICOM UR 599-599 BK ↓
RT5	↓ 73 GL SK ↓
RT6	↓ CQ CQ CQ DE ICOM ICOM ICOM K ↓
RT7	↓ MY TRANSCEIVER IS IC-7300 & ANTENNA IS A 3-ELEMENT TRIBAND YAGI. ↓
RT8	↓ MY RTTY EQUIPMENT IS INTERNAL FSK UNIT & DEMODULATOR OF THE IC-7300. ↓

TIP: When an external keypad is connected to the [MIC] jack, you can transmit the RTTY memories using the external keypad. See page 18-3 for details.

4 RECEIVING AND TRANSMITTING

Operating RTTY (FSK)

◇ Editing an RTTY memory

You can edit the characters in the RTTY memories.
You can save and transmit 8 RTTY memories for often-used RTTY messages.
Each RTTY memory contains up to 70 characters.

1. Open the RTTY MEMORY screen.

MENU » **DECODE > TX MEM > EDIT**

2. Touch the memory for 1 second.
(Example: RT3)

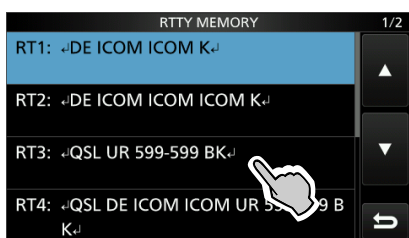

RTTY MEMORY screen

3. Touch "Edit."

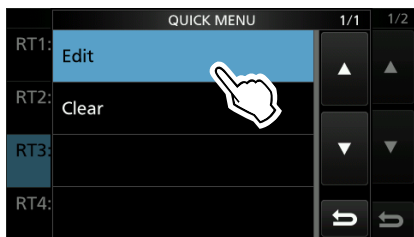

QUICK MENU screen

4. Touch [CLR] until the characters are cleared.

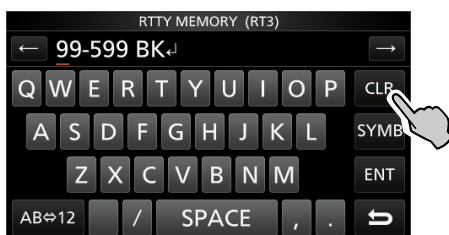

5. Enter the desired characters, and then touch [ENT] to save.

① See "Keyboard entering and editing" (p. 1-9) for details.

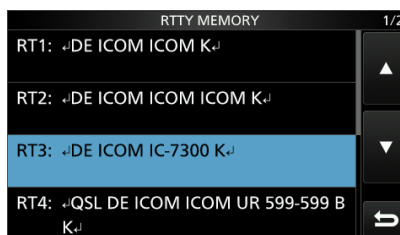

6. To close the RTTY DECODE screen, push **EXIT** several times.

4 RECEIVING AND TRANSMITTING

Operating RTTY (FSK)

◇ Turning ON the RTTY log

Turn ON the RTTY log to save your TX and RX RTTY operating record onto an SD card (user supplied).

1. Insert an SD card into the IC-7300. (p. 8-2)
2. Open the RTTY DECODE LOG screen in the RTTY mode.

MENU » **DECODE > <1> > LOG**

3. Select "Decode Log."

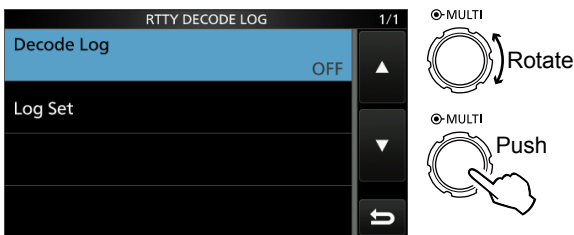

4. Select "ON."

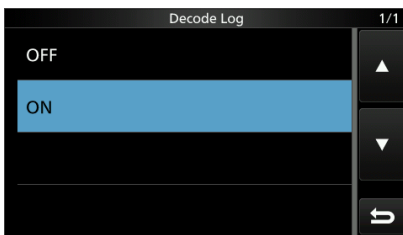

5. Push **EXIT**.
 - "●" is displayed on the RTTY DECODE screen when the RTTY log is ON.



6. To turn OFF the RTTY log, select "OFF" in step 4.

TIP: How to reset to the default setting

Touching the item or its option for 1 second displays the Quick menu, and then touch "Default" to reset to the default setting.

◇ Viewing the RTTY log contents

You can check the RTTY log contents.

1. Insert an SD card with the desired log. (p. 8-2)
2. Open the RTTY DECODE LOG VIEW screen in the RTTY mode.

MENU » **DECODE > <1> > LOG VIEW**

3. Select the desired log file to view.
 - ① The file with "●" is logging. You cannot check this log's contents.

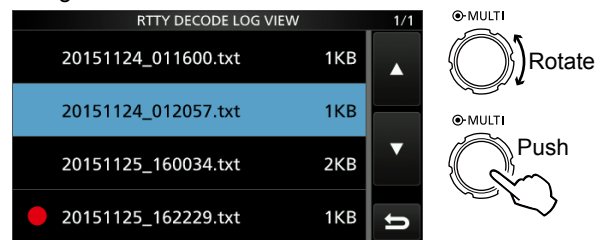

RTTY DECODE LOG VIEW screen

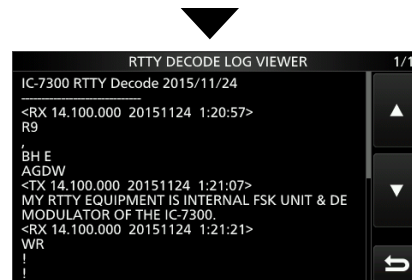

Example of a log saved in the text format.

4. To close the RTTY DECODE screen, push **EXIT** several times.

4 RECEIVING AND TRANSMITTING

Operating RTTY (FSK)

◇ About the RTTY decode log set mode

This mode is for the log file type, time stamp setting, and other RTTY settings.

1. Open the RTTY DECODE LOG screen in the RTTY mode.

MENU » **DECODE > <2> > LOG**

2. Select “Log Set.”

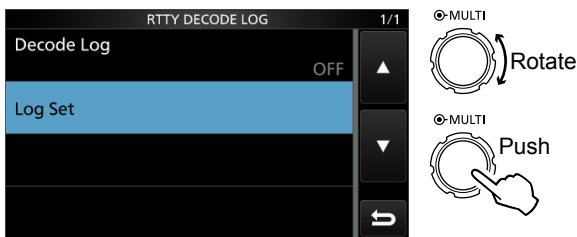

3. Select the desired item.
(Example: File Type)

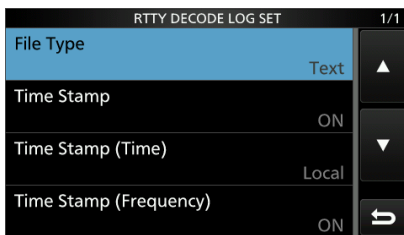

4. Select the desired setting, item or value.
(Example: HTML)



5. To close the RTTY DECODE screen, push **EXIT** several times.

TIP: How to reset to the default setting

Touching the item or its option for 1 second displays the Quick menu, and then touch “Default” to reset to the default setting.

File Type (Default: Text)

Select the file type to save a log onto an SD card to Text or HTML.

① You cannot change the file type while logging.

Time Stamp (Default: ON)

Select whether or not to add the time stamp (date, transmission time and reception time) in the log.

- ON: Adds the time stamp in the log
- OFF: Does not add the time stamp

Time Stamp (Time) (Default: Local)

Select whether to save the log with the local time or with the UTC time.

Time Stamp (Frequency) (Default: ON)

Select whether or not to add the frequency in the log.

- ON: Adds the frequency
- OFF: Does not add the frequency

4 RECEIVING AND TRANSMITTING

Operating RTTY (FSK)

◇ About the RTTY decode set mode

This set mode is for the FFT scope setting, USOS function, and so on.

1. Open the RTTY DECODE screen in the RTTY mode.

MENU » **DECODE**

2. Touch [EXPD/SET] for 1 second.
 - Opens the RTTY DECODE SET screen.

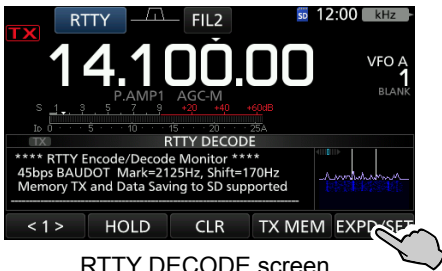

RTTY DECODE screen

3. Select the desired item to set (Example: FFT Scope Averaging)

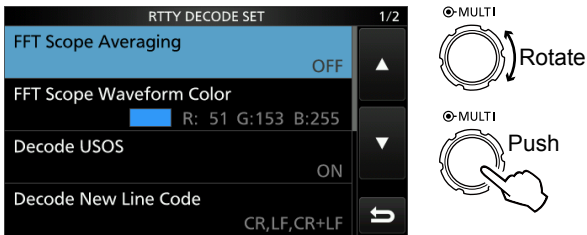

RTTY DECODE SET screen

4. Select the desired option or setting. (Example: 2)

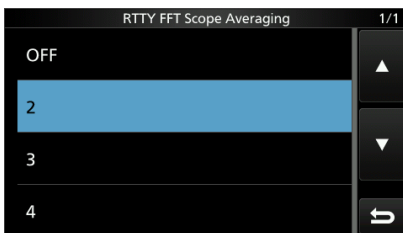

5. To close the RTTY DECODE screen, push **EXIT** several times.

TIP: How to reset to the default setting

Touching the item or its option for 1 second displays the Quick menu, and then touch "Default" to reset to the default setting.

FFT Scope Averaging (Default: OFF)

Set the FFT scope waveform averaging function to between 2 and 4 or to OFF.

- ① Use the default or smaller FFT scope waveform number for tuning.

FFT Scope Waveform Color

(Default: R: 51, G: 153, B: 255)

Set the color of the FFT scope waveform.

- ① Touch and select the R (Red), G (Green) or B (Blue) scale, and then rotate **MULTI** to adjust the ratio to between 0 and 255.

- ① The color is displayed in the box above the RGB scale.

Decode USOS (Default: ON)

Turn the letter code decoding capability ON or OFF after receiving a "space."

- ① USOS stands for UnShift On Space function.

- ON: Decodes as a letter code.
- OFF: Decodes as a character code.

Decode New Line Code

(Default: CR, LF, CR+LF)

Select the internal RTTY decoder new line code.

- ① CR stands for Carriage Return, and LF stands for Line Feed.

- CR,LF,CR+LF: Makes a new line with any codes.
- CR+LF: Makes a new line with only CR+LF code.

TX USOS (Default: ON)

Explicitly inserts the FIGS character, even though it is not required by the receiving station.

- ON: Inserts FIGS
- OFF: Does not insert FIGS

Font Color (Receive)

(Default: R: 128, G: 255, B: 128)

Set the text font color for received characters.

- ① Touch and select the R (Red), G (Green) or B (Blue) scale, and then rotate **MULTI** to adjust the ratio to between 0 and 255.

- ① The color is displayed in the box above the RGB scale.

Font Color (Transmit)

(Default: R: 255, G: 106, B: 106)

Set the text color for transmitted characters.

- ① Touch and select the R (Red), G (Green) or B (Blue) scale, and then rotate **MULTI** to adjust the ratio to between 0 and 255.

- ① The color is displayed in the box above the RGB scale.

FM repeater operation

A repeater receives your radio's signals and simultaneously retransmits them on a different frequency to provide a greater communication range. When using a repeater, the transmit frequency shifts from the receive frequency by an offset amount. You can access a repeater using the split function.

1. Select the desired operating band. (p. 3-3)
(Example: 28 MHz band)
2. Rotate **(MAIN DIAL)** to set the operating frequency.

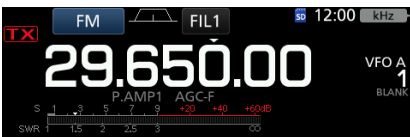

(Example: 29.650.00 MHz)

3. Select the FM mode.
4. Hold down **(SPLIT)** for 1 second.
 - Turns the Split function ON.
 - Turns the Tone function ON and "TONE" is displayed.
 - Displays the transmit frequency.

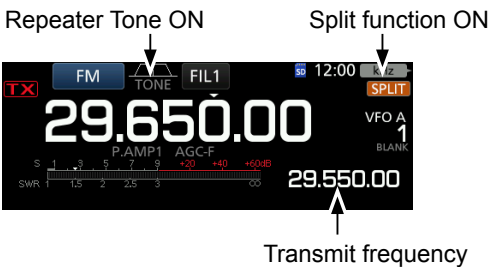

① You can set the frequency offset for the HF band.
(p. 12-5)

(MENU) » SET > Function > SPLIT > FM SPLIT Offset (HF)

① You can set the frequency offset for the 50 MHz band.
(p. 12-5)

(MENU) » SET > Function > SPLIT > FM SPLIT Offset (50M)

◇ Setting the repeater tone frequency

Some repeaters require a subaudible tone to be accessed. Subaudible tones are superimposed on your signal, and must be set in advance. Do the following steps to set the tone frequency.

1. Select the FM mode.
2. Push **(FUNCTION)**.
 - Opens the FUNCTION screen.
3. Touch [TONE] for 1 second.

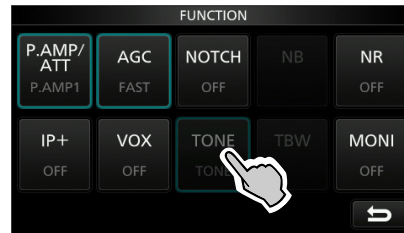

FUNCTION screen (FM mode)

4. Rotate **(MAIN DIAL)** to select the desired subaudible tone frequency.

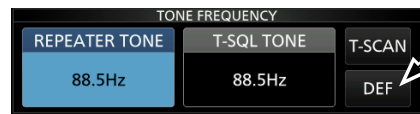

TONE FREQUENCY screen

Touch for 1 second to reset to the default.

• Selectable tone frequencies

67.0	88.5	114.8	151.4	177.3	203.5	250.3
69.3	91.5	118.8	156.7	179.9	206.5	254.1
71.9	94.8	123.0	159.8	183.5	210.7	
74.4	97.4	127.3	162.2	186.2	218.1	
77.0	100.0	131.8	165.5	189.9	225.7	
79.7	103.5	136.5	167.9	192.8	229.1	
82.5	107.2	141.3	171.3	196.6	233.6	
85.4	110.9	146.2	173.8	199.5	241.8	

Checking the repeater tone frequency

You can check the tone frequency by receiving the repeater's input frequency and tone scanning. To receive the input signals, the transceiver detects the subaudible tone frequency using the tone scan function.

1. Touch [T-SCAN].
 - The scan starts, and then stops when the matching tone frequency as the repeater is received.



2. To close the TONE FREQUENCY screen, push **(EXIT)**.

4 RECEIVING AND TRANSMITTING

FM repeater operation

◇ Checking the repeater input signal

You can check whether you can directly receive another station's transmit signal or not, by listening to the repeater input frequency.

While receiving, hold down **(XFC)** to listen the repeater input frequency.

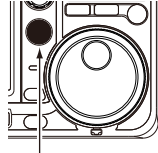

While holding down

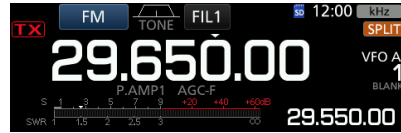

Split function ON

While holding down **(XFC)**. Release **(XFC)**.

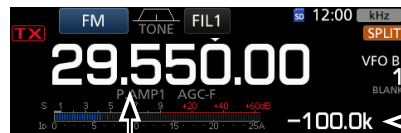

Another station's transmit frequency

Frequency offset

Tone squelch operation

The Tone squelch opens only when you receive a signal that includes a matching subaudible tone in the FM mode. You can silently wait for calls from other stations using the same tone.

When you transmit, the tone frequency is superimposed on your own signal.

1. Select the desired operating band.
(Example: 28 MHz)
2. Select the FM mode.
3. Rotate **(MAIN DIAL)** to set the operating frequency.
(Example: 29.550.00 MHz)



4. Push **(FUNCTION)**.
• Opens the FUNCTION screen.
5. Touch **[TONE]** several times to select the Tone squelch mode.
• "TSQL" is displayed.
① Touching **[TONE]** selects "TONE," "TSQL" or OFF.



FUNCTION screen (FM mode)

6. Touch **[TONE]** again for 1 second.

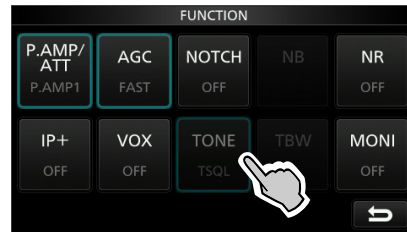

- Opens the TONE FREQUENCY screen.

7. Rotate **(MAIN DIAL)** to set the tone frequency.

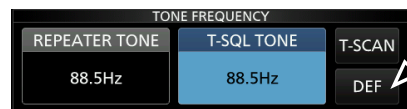

TONE FREQUENCY screen

Touch for 1 second to reset to the default.

• Selectable tone frequencies

67.0	88.5	114.8	151.4	177.3	203.5	250.3
69.3	91.5	118.8	156.7	179.9	206.5	254.1
71.9	94.8	123.0	159.8	183.5	210.7	
74.4	97.4	127.3	162.2	186.2	218.1	
77.0	100.0	131.8	165.5	189.9	225.7	
79.7	103.5	136.5	167.9	192.8	229.1	
82.5	107.2	141.3	171.3	196.6	233.6	
85.4	110.9	146.2	173.8	199.5	241.8	

Checking another station's tone frequency

You can check another station's tone frequency by tone scanning while the station is transmitting.

1. Touch **[T-SCAN]**.

- The scan starts, and then stops when the matching tone frequency as another station is received.



Blinks while scanning

2. To close the TONE FREQUENCY screen, push **(EXIT)**.

Data mode operation

You can operate the data mode using AFSK (Audio Frequency Shift Keying).

①When operating RTTY in the AFSK mode, PSK31, SSTV, JT65, or FT8 with a PC application software, refer to the software's instruction manual.

1. Connect a PC or other device to the transceiver.
①See "FSK and AFSK connections" (p. 2-5) for connection details.
2. Select the operating band.
(Example: 51 MHz)
3. Set the data operating mode to LSB-D, USB-D, AM-D or FM-D.
(Example: FM-D)

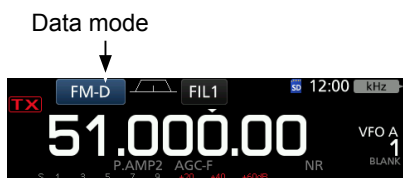

4. Refer to the application software for communication details.
①When operating in the SSB data mode, adjust the device's output level within the ALC zone.

TIP: The carrier point is displayed when operating AFSK in the SSB data mode.
See the illustration below for a tone-pair example.

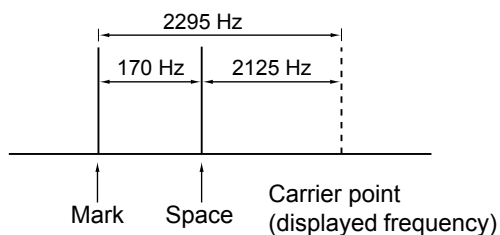

Section 5 SCOPE OPERATION

Spectrum scope screen.....	5-2
◇ Using the Spectrum Scope	5-2
◇ Center mode	5-3
◇ Fixed mode	5-3
◇ Scroll mode	5-3
◇ Marker.....	5-3
◇ Touch screen operation	5-4
◇ Mini scope screen.....	5-4
◇ Adjusting the Reference level	5-5
◇ Sweep speed	5-5
◇ Scope set screen	5-6
Audio scope screen.....	5-9
◇ Audio scope set screen	5-9

Spectrum scope screen

This spectrum scope enables you to display the activity on the selected band, as well as the relative strengths of various signals.

The IC-7300 has two spectrum scope modes. One is the Center mode, and another one is the Fixed mode. You can also turn the Waterfall display ON or OFF. In addition, you can select a Mini scope screen to save screen space.

• Center mode screen

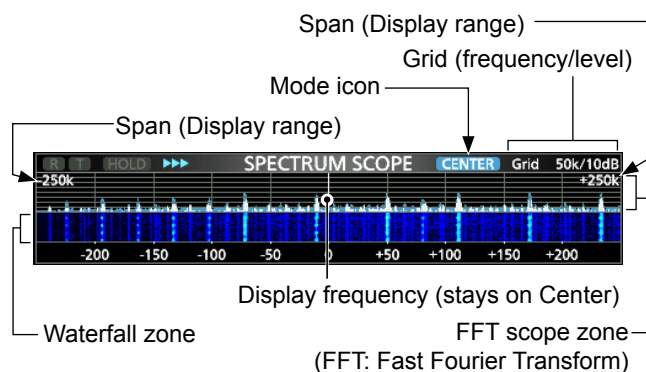

• Fixed mode screen

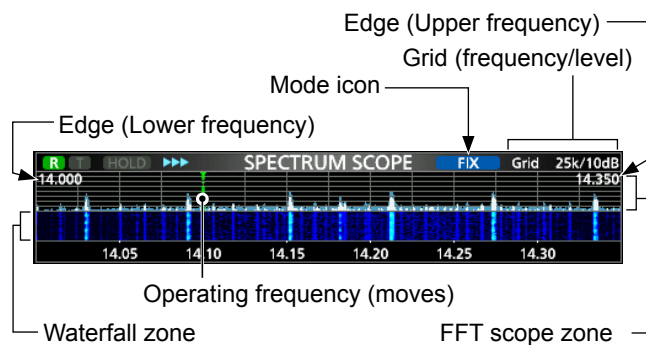

• Scroll mode screen

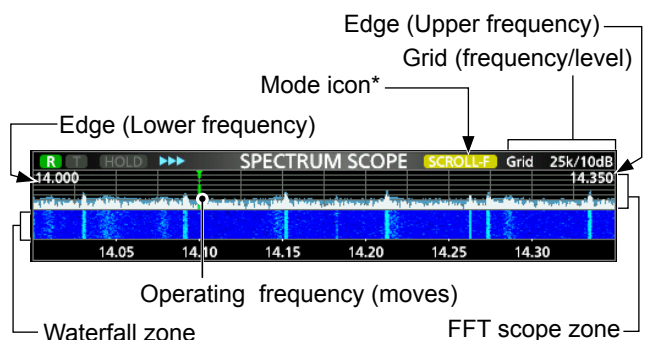

* When in the SCROLL-C mode, **SCROLL-C** is displayed.

◇ Using the Spectrum Scope

- Open the SPECTRUM SCOPE screen.

MENU » **SCOPE**

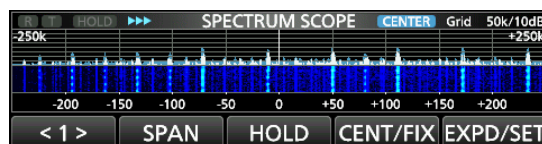

MENU 1: Center/Scroll-C mode



MENU 1: Fixed/Scroll-F mode



MENU 2: Center/Fixed/Scroll-C/Scroll-F mode

Key	Action	
< 1 > < 2 >	Selects the Function menus.	
SPAN	Touch	In the Center mode and the Scroll mode, selects the scope span. • ±2.5, 5.0, 10, 25, 50, 100, 250 and 500 kHz
	Touch for 1 second	Resets to the ±2.5 kHz span.
EDGE	In the Fixed mode and the Scroll mode, selects the Edge frequencies. ① You can set the Upper and lower Edge frequencies in the SCOPE SET screen by touching [EXPD/SET] for 1 second. (p. 5-6 ~ p. 5-8)	
HOLD	Touch	Turns the Hold function to ON or OFF. • “[HOLD]” and the Marker are displayed. Freezes the current spectrum.
	Touch for 1 second	Clears the Peak Hold level.
CENT/FIX	Touch	Selects the Center or Fixed mode.
	Touch for 1 second	Selects the Scroll mode.
EXPD/SET	Touch	Selects the Expanded or Normal screen.
	Touch for 1 second	Enters the SCOPE SET screen. ① See the Full Manual for details.
REF	Displays the Reference level window. ① Rotate (MAIN DIAL) to adjust the Reference level. ① Touch again to close the window.	
SPEED	Selects the sweep speed. • “▶▶▶” (FAST), “▶▶” (MID), or “▶” SLOW.	
MARKER	Selects the Marker.	

- To exit the SPECTRUM SCOPE screen, push **EXIT**.

5 SCOPE OPERATION

Spectrum scope screen

◇ Center mode

Displays signals around the operating frequency within the selected span. The operating frequency is always displayed in the center of the screen.

1. Open the SPECTRUM SCOPE screen.

MENU » **SCOPE**

2. Touch [CENT/FIX].
 - ① Touch [CENT/FIX] to toggle between the Center and Fixed modes.
3. Touch [SPAN] several times to select the scope span.
 - Selectable span: $\pm 2.5, 5.0, 10, 25, 50, 100, 250$ and 500 kHz
 - ① Touch [SPAN] for 1 second to select the ± 2.5 kHz span.

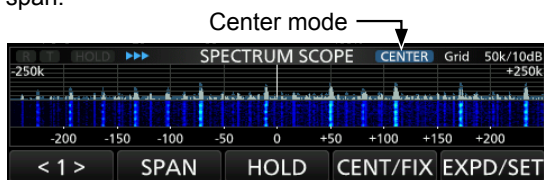

◇ Fixed mode

Displays signals within a specified frequency range. The selected frequency band activity can easily be observed using this mode. Four Fixed Edge bands can be set for each amateur frequency band covered by the transceiver. See page 5-7 for setting details.

1. Open the SPECTRUM SCOPE screen.

MENU » **SCOPE**

2. Touch [CENT/FIX].
 - “**FIX**” is displayed when the Fixed mode is selected.
 - ① Touch [CENT/FIX] to toggle between the Center and Fixed modes.
 3. Touch [EDGE] several times until the desired Fixed Edge frequency band is selected.
 - ① When the operating frequency moves outside the upper or lower Edge frequency, “<<” or “>>” is displayed in the upper side corners of the SPECTRUM SCOPE screen.
 - <<: The frequency is outside the lower edge.
 - >>: The frequency is outside the higher edge.
- When the frequency goes further away, “Scope Out of Range” is displayed.

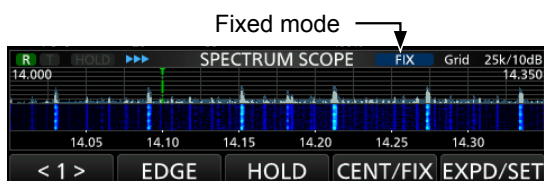

◇ Scroll mode

Displays signals within a selected span. When the operating frequency moves outside of the screen, the displayed frequency range is automatically scrolled.

1. Display the SPECTRUM SCOPE screen.

MENU » **SCOPE**

2. Touch [CENT/FIX] for 1 second to select the Scroll mode.
 - When changing the Center mode to the Scroll mode, “SCROLL-C” is displayed. You can change the scope span by touching [SPAN].
 - When changing the Fixed mode to the Scroll mode, “SCROLL-F” is displayed. You can change the Edge frequencies by touching [EDGE].
3. Touch [CENT/FIX] to return to the previous mode.
 - When returning to the Center mode, the scope span does not return to the previous setting.
 - When returning to the Fixed mode, the Edge frequencies return to the last selected “Fixed Edges.” If the operating frequency is above the upper Edge frequency, or below the lower Edge frequency, “<<” or “>>” is displayed in the upper side corners of the SPECTRUM SCOPE screen.

◇ Marker

The Marker displays the operating frequency in the SPECTRUM SCOPE screen.

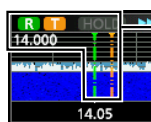

- R: The RX marker
- Marks the receive frequency.
- T: The TX marker
- Marks the transmit frequency.

• About RX Marker

In the Fixed mode and the Scroll mode, the RX Marker displays the operating frequency within a specified frequency range. So, the transceiver always displays the RX marker in the scope screen. In the Center mode, the operating frequency stays on the Center of the screen. Thus, the transceiver does not display the RX Marker.

- ① When the Hold function is ON, the RX Marker is displayed to indicate the operating frequency's location.

5 SCOPE OPERATION

Spectrum scope screen

◇ Touch screen operation

When you touch the FFT scope zone or the waterfall zone in the SPECTRUM SCOPE screen, the area will be zoomed in. Then you touch the signal in the zoomed area, you can directly tune your frequency to the signal in the SPECTRUM SCOPE screen.

① Holding down **[XFC]** changes the transmit frequency.

1. Open the SPECTRUM SCOPE screen.

[MENU] » **[SCOPE]**

2. Touch the Scope screen.

- A section around the touched area is zoomed in.

① Touch only the FFT scope zone or Waterfall zone.

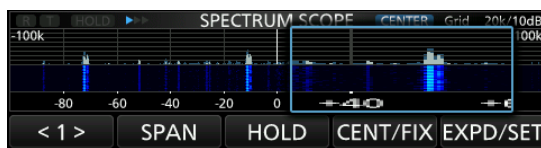
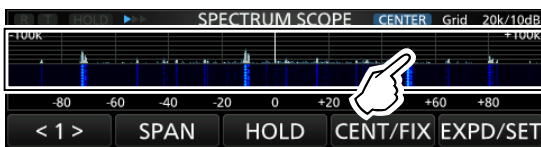

3. Touch the signal in the zoomed area.

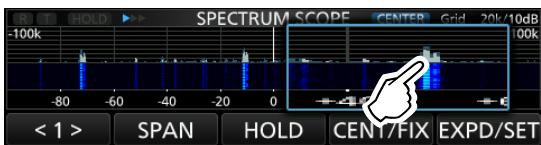

① Information

- In the Center mode, the operating frequency changes to the touched point, and the point moves to the screen center.
 - In the Fixed mode, the operating frequency and marker change to the touched point.
 - Touch out of the zoomed area to close the zoomed window.
4. To exit the SPECTRUM SCOPE screen, push **[EXIT]**.

◇ Mini scope screen

The Mini scope screen can be simultaneously displayed with another function displays, such as the RTTY DECODE screen and the AUDIO SCOPE screen.

Push **[M.SCOPE]** to turn the Mini scope screen ON or OFF.

① Hold down **[M.SCOPE]** for 1 second to display the SPECTRUM SCOPE screen.

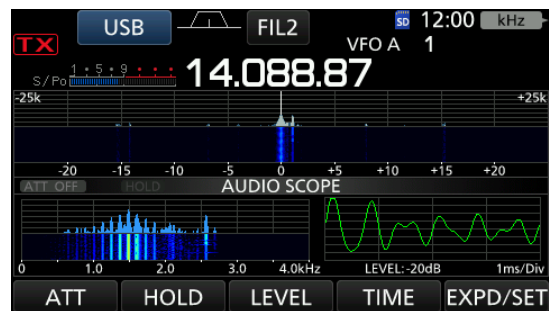

Mini scope screen with the AUDIO SCOPE screen

Spectrum scope screen

◇ Adjusting the Reference level

When monitoring a weak signal that is buried in the noise floor, or monitoring a strong signal but some stronger signals are nearby, adjusting the Reference level of the screen helps to see these signals.

- Even if this setting is changed, it does not affect the scope input level.
- When you adjust the Reference level, the signal strength for the waterfall also appears to change.

1. Open the SPECTRUM SCOPE screen.



2. Touch [**<1>**].

- The function menu changes to Menu 2.

3. Touch [**REF**].

- Opens the Reference level window.

① Touch [**REF**] to open or close the window.

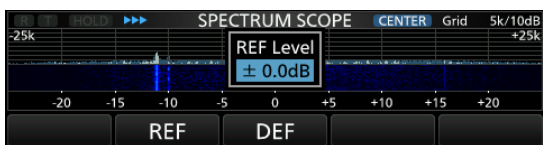
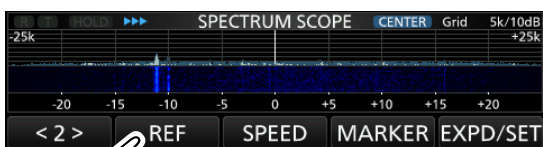

4. Rotate (**MAIN DIAL**) to adjust the level.

- Adjustable range: -20.0 dB ~ +20.0 dB

① Touch [**REF**] for 1 second to select ±0.0 dB.

Difference spectrum (+20.0, ±0.0, -20.0 dB)

Reference level
(+20.0 dB)

Reference level
(-20.0 dB)

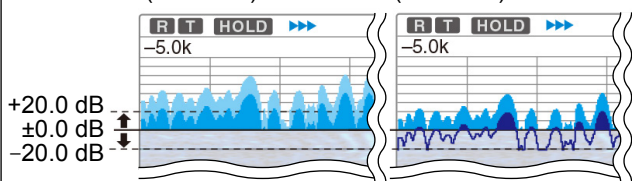

① If you adjust this setting to a positive level, all signal levels appear stronger.

Or, if you adjust to a negative level, all signal levels appear weaker.

5. Touch [**REF**].

- Closes the Reference level window.

6. To exit the SPECTRUM SCOPE screen, push (**EXIT**).

◇ Sweep speed

Select the sweep speed to change the FFT scope refresh speed and the waterfall speed.

① To change only the waterfall speed, select “Slow,” “Mid,” or “Fast” in the Scope set screen. (p. 5-7)

1. Open the SPECTRUM SCOPE screen.



2. Touch [**<1>**].

- The function menu changes to Menu 2.

3. Touch [**SPEED**] several times until the desired sweep speed is selected.

- Selectable speeds: FAST, MID, or SLOW

① “▶▶▶,” “▶▶,” or “▶” indicates FAST, MID, or SLOW.

① A popup window appears in the center of SPECTRUM SCOPE screen and displays the selected sweep speed for 1 second.

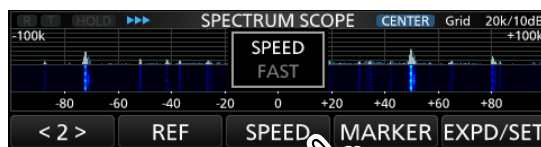

Sweep speed (FAST)

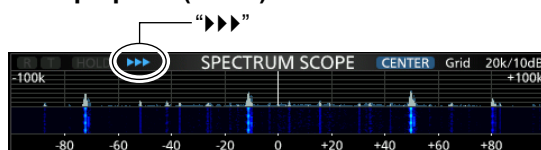

Sweep speed (MID)

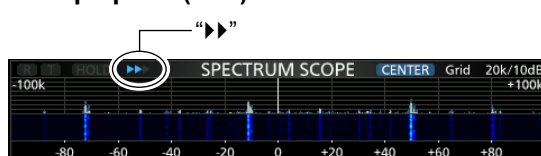

Sweep speed (SLOW)

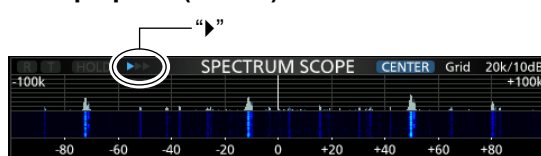

4. To exit the SPECTRUM SCOPE screen, push (**EXIT**).

5 SCOPE OPERATION

Spectrum scope screen

◇ Scope set screen

This Set screen is used to set the waveform color, Scope range for the Fixed mode, and so on.

1. Open the SPECTRUM SCOPE screen.

MENU » **SCOPE**

2. Touch [EXPD/SET] for 1 second.
3. Select the desired item.

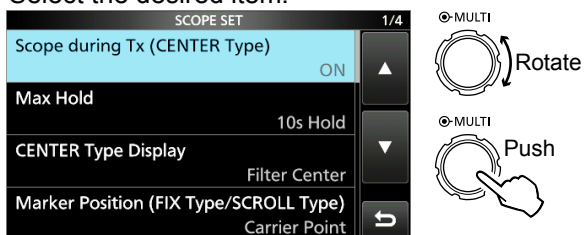

4. Select the option or set the level.
① See below for details of the setting items and their options.

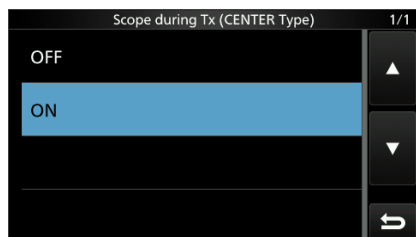

5. To exit the SPECTRUM SCOPE screen, push **EXIT** several times.

TIP: How to reset to the default setting

Touching the item or its option for 1 second displays the Quick menu, and then touch "Default" to reset to the default setting.

Scope during TX (CENTER TYPE) (Default: ON)

Set the TX signal display to ON or OFF.

Max Hold (Default: 10s Hold)

Select the peak level holding function.

- OFF: Turns OFF the peak level holding function.
- 10s Hold: Holds the peak spectrum for 10 seconds.
- ON: Continuously holds the peak spectrum.

CENTER Type Display (Default: Filter Center)

Select the center frequency of the SPECTRUM SCOPE screen. (Only in the Center mode)

- Filter Center: Displays the selected filter's center frequency at the center of the SPECTRUM SCOPE screen.
- Carrier Point Center: Displays the carrier point frequency of the selected operating mode at the center of the SPECTRUM SCOPE screen.
- Carrier Point Center (Abs. Freq.): In addition to the carrier point center setting above, the actual frequency is displayed at the bottom of the scope.
① Abs. Freq. : Absolute Frequency

Marker Position (Fix Type/Scroll Type)

(Default: Carrier Point)

Select the marker position on the SPECTRUM SCOPE screen. (Only in the Fixed mode and the Scroll mode)

- Filter Center: Displays the Marker on the selected filter's center frequency.
- Carrier Point: Displays the Marker on the carrier point frequency of the selected operating mode.

VBW (Default: Narrow)

Select the Video Band Width (VBW).

- Narrow: Sets the VBW to narrow.
- Wide: Sets the VBW to wide.
- ① When "Wide" is selected, the line drawn on the receive spectrum becomes wide. However, the small edge cannot be drawn.

Averaging (Default: OFF)

Set the FFT scope waveform averaging function to between 2 and 4, or OFF.

- OFF: The FFT scope screen refreshes at each sweep time. This setting displays the critical spectrum view.
- 2, 3, 4: The FFT scope screen averages 2 to 4 sweeps to smoothly display the spectrum.

Waveform Type (Default: Fill)

Select the outline waveform display for the FFT scope screen.

- Fill: The waveform is drawn only in color.
- Fill + Line: The waveform is drawn in color with an outline.

5 SCOPE OPERATION

Spectrum scope screen

◇ Scope set screen

Waveform Color (Current)

(Default: (R) 172 (G) 191 (B) 191)

Set the waveform color for the currently received signals.

- ① Touch and select the R (Red), G (Green) or B (Blue) scale, and then rotate **(MULTI)** to adjust the ratio from 0 to 255.
- ① The color is displayed in the box above the RGB scale.

Waveform Color (Line)

(Default: (R) 56 (G) 24 (B) 0)

Set the waveform outline color for the currently received signals.

- ① Touch and select the R (Red), G (Green) or B (Blue) scale, and then rotate **(MULTI)** to adjust the ratio from 0 to 255.
- ① The color is displayed in the box above the RGB scale.

Waveform Color (Max Hold)

(Default: (R) 45 (G) 86 (B) 115)

Set the waveform color for the received signals maximum level.

- ① Touch and select the R (Red), G (Green) or B (Blue) scale, and then rotate **(MULTI)** to adjust the ratio from 0 to 255.
- ① The color is displayed in the box above the RGB scale.

Waterfall Display

(Default: ON)

Turn the Waterfall display ON or OFF for the normal scope or Mini scope screens.

- ① In the Expanded scope screen, the Waterfall is always displayed.
- OFF: Turns OFF the Waterfall display.
- ON: Turns ON the Waterfall display.

Waterfall Speed

(Default: Mid)

Select the Waterfall speed.

- Slow: Sets the waterfall speed to Slow.
- Mid: Sets the waterfall speed to Mid.
- Fast: Sets the waterfall speed to Fast.

Waterfall Size (Expand Screen)

(Default: Mid)

Select the Waterfall height in the Expand scope screen.

- Small: The same height with the Normal scope screen, only the FFT scope expands.
- Mid: The Waterfall height expands at the same ratio with the FFT scope.
- Large: Only the Waterfall height expands.

Waterfall Peak Color Level

(Default: Grid 8)

Select the signal level that the Waterfall displays a peak color.

Higher signal levels are Red, Yellow, Green, Light-blue, Blue and Black, in that order.

- Selection: Grid 1 ~ Grid 8

Waterfall Marker Auto-hide

(Default: ON)

Set the Waterfall Marker Auto-hide function to ON or OFF.

- OFF: The marker in the Waterfall zone stays ON.
- ON: The marker in the Waterfall zone is hidden 2 seconds after you have stopped it in place.

Fixed Edges

0.03 – 1.60

(Default: No.1 0.500–1.500 MHz)

(Default: No.2 0.500–1.500 MHz)

(Default: No.3 0.500–1.500 MHz)

(Default: No.4 0.500–0.550 MHz)

Set the Upper and Lower Edge frequencies for the Fixed mode. Four edges are assigned to each band.

NOTE:

- First set the lower Edge frequency.
- Set the upper Edge frequency within 1 MHz of the lower frequency.

- Settable range: 0.030 ~ 1.600 MHz



- ① Touch **◀▶** to select the Upper or Lower frequency, and then rotate **(MULTI)** to select the frequency.
- ① You can also directly enter the edge frequency using the keypad.

5 SCOPE OPERATION

Spectrum scope screen

◇ Scope set screen

1.60 – 2.00 (Default: No.1 1.800–2.000 MHz)
(Default: No.2 1.800–1.830 MHz)
(Default: No.3 1.900–1.930 MHz)
(Default: No.4 1.800–1.850 MHz)

- Settable range: 1.600 ~ 2.000 MHz

2.00 – 6.00 (Default: No.1 3.500–4.000 MHz)
(Default: No.2 3.500–3.575 MHz)
(Default: No.3 3.750–3.850 MHz)
(Default: No.4 3.500–3.550 MHz)

- Settable range: 2.000 ~ 6.000 MHz

6.00 – 8.00 (Default: No.1 7.000–7.300 MHz)
(Default: No.2 7.000–7.030 MHz)
(Default: No.3 7.030–7.200 MHz)
(Default: No.4 7.000–7.050 MHz)

- Settable range: 6.000 ~ 8.000 MHz

8.00 – 11.00 (Default: No.1 10.100–10.150 MHz)
(Default: No.2 10.100–10.130 MHz)
(Default: No.3 10.130–10.150 MHz)
(Default: No.4 10.100–10.150 MHz)

- Settable range: 8.000 ~ 11.000 MHz

11.00 – 15.00 (Default: No.1 14.000–14.350 MHz)
(Default: No.2 14.000–14.100 MHz)
(Default: No.3 14.100–14.350 MHz)
(Default: No.4 14.000–14.050 MHz)

- Settable range: 11.000 ~ 15.000 MHz

15.00 – 20.00 (Default: No.1 18.068–18.168 MHz)
(Default: No.2 18.068–18.110 MHz)
(Default: No.3 18.110–18.168 MHz)
(Default: No.4 18.000–18.050 MHz)

- Settable range: 15.000 ~ 20.000 MHz

20.00 – 22.00 (Default: No.1 21.000–21.450 MHz)
(Default: No.2 21.000–21.150 MHz)
(Default: No.3 21.150–21.450 MHz)
(Default: No.4 21.000–21.050 MHz)

- Settable range: 20.000 ~ 22.000 MHz

22.00 – 26.00 (Default: No.1 24.890–24.990 MHz)
(Default: No.2 24.890–24.930 MHz)
(Default: No.3 24.930–24.990 MHz)
(Default: No.4 24.900–24.950 MHz)

- Settable range: 22.000 ~ 26.000 MHz

26.00 – 30.00 (Default: No.1 28.000–29.000 MHz)
(Default: No.2 28.000–28.200 MHz)
(Default: No.3 28.200–29.000 MHz)
(Default: No.4 28.000–28.100 MHz)

- Settable range: 26.000 ~ 30.000 MHz

30.00 – 45.00 (Default: No.1 30.000–31.000 MHz)
(Default: No.2 30.000–31.000 MHz)
(Default: No.3 30.000–31.000 MHz)
(Default: No.4 30.000–30.100 MHz)

- Settable range: 30.000 ~ 45.000 MHz

45.00 – 60.00 (Default: No.1 50.000–51.000 MHz)
(Default: No.2 50.000–50.100 MHz)
(Default: No.3 50.100–50.300 MHz)
(Default: No.4 50.000–50.100 MHz)

- Settable range: 45.000 ~ 60.000 MHz

60.00 – 74.80 (Default: No.1 70.000–70.500 MHz)
(Default: No.2 70.000–70.250 MHz)
(Default: No.3 70.250–70.500 MHz)
(Default: No.4 70.000–70.100 MHz)

- Settable range: 60.000 ~ 74.800 MHz

Audio scope screen

This audio scope enables you to display the received signal's frequency component on the FFT scope, and its waveform components on the Oscilloscope. The FFT scope also has a waterfall.

1. Open the AUDIO SCOPE screen.

MENU » **AUDIO**



AUDIO SCOPE screen

Key	Action	
ATT	Touch	Selects the attenuator for the FFT scope. • 0 (OFF), 10, 20, or 30 dB
	Touch for 1 second	Turns OFF the attenuator. (0 dB)
HOLD	Sets the Hold function to ON or OFF. • "[HOLD]" is displayed and freezes the current audio spectrum.	
LEVEL	Selects the Oscilloscope level. • 0, -10, -20, or -30 dB	
TIME	Selects the Oscilloscope sweep time. • 1, 3, 10, 30, 100, or 300 ms/Div	
EXPD/ SET	Touch	Selects the Expanded or Normal screen.
	Touch for 1 second	Enters the AUDIO SCOPE SET screen.

2. To exit the AUDIO SCOPE screen, push **EXIT**.

• **AUDIO SCOPE screen**

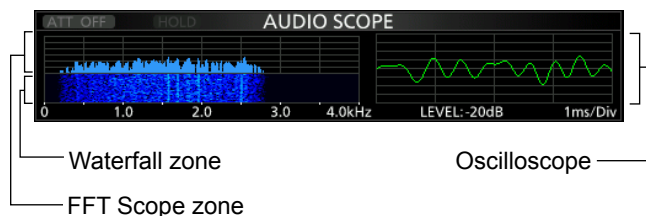

TIP: How to reset to the default setting
Touching the item or its option for 1 second displays the Quick menu, and then touch "Default" to reset to the default setting.

◇ **Audio scope set screen**

This Set mode is used to set the FFT scope waveform type, color, Waterfall display and oscilloscope waveform color.

1. Open the AUDIO SCOPE screen.

MENU » **AUDIO**

2. Touch [EXPD/SET] for 1 second.
3. Select the desired item.

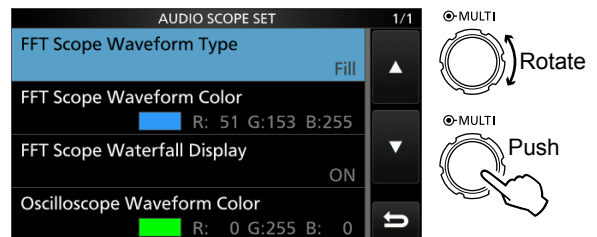

4. Rotate **(MULTI)** to select the option or set the level, and then push **(MULTI)**.
 - See below for details of the setting items and their options.
5. To exit the AUDIO SCOPE screen, push **EXIT** several times.

FFT Scope Waveform Type (Default: Fill)

Select the type of waveform for the FFT scope.

- Fill: The full waveform is drawn in color.
- Line: Only the waveform outline is drawn.

FFT Scope Waveform Color

(Default: (R) 51 (G) 153 (B) 255)

Set the waveform color for the FFT scope.

- ① Touch and select the R (Red), G (Green) or B (Blue) scale, and then rotate **(MULTI)** to adjust the ratio from 0 to 255.
- ① The color is displayed in the box above the RGB scale.

FFT Scope Waterfall Display (Default: ON)

Turn the Waterfall display ON or OFF.

- OFF: Turns OFF the Waterfall display.
- ON: Turns ON the Waterfall display.

Oscilloscope Waveform Color

(Default: (R) 0 (G) 255 (B) 0)

Set the waveform color for the Oscilloscope.

- ① Touch and select the R (Red), G (Green) or B (Blue) scale, and then rotate **(MULTI)** to adjust the ratio from 0 to 255.
- ① The color is displayed in the box above the RGB scale.

Recording a QSO audio	6-2
◇ Quick recording.....	6-2
◇ Basic recording	6-2
Playing back a QSO audio	6-3
Operation while playing back.....	6-3
◇ Fast forward while playing	6-3
◇ Rewind while playing	6-3
◇ Pause while playing	6-3
◇ Playing the previous file.....	6-3
◇ Playing the next file.....	6-3
◇ Moving to the beginning of the previous file	6-3
◇ Moving to the beginning of the next file	6-3
◇ VOICE PLAYER screen	6-4
Checking the file information	6-4
Checking the folder information.....	6-5
Deleting a file.....	6-5
◇ Deleting all files.....	6-5
Deleting a folder	6-6
◇ Deleting all folders	6-6
SD Card information	6-6
Playing back the recorded file on the PC	6-7
RECORDER SET screen	6-8
PLAYER SET screen.....	6-9

Recording a QSO audio

This transceiver is equipped with a QSO recorder not only for the receive audio, but also for the transmit audio.

This function is useful to make a QSO record or to confirm your QSO with a rare entity's station or on a DX'pedition. You can also use the function to repeatedly send the same message.

The recorded contents are saved onto an SD card. There are 2 ways to record the communication.

NOTE:

- To record a QSO, an SD card (user supplied) is required.
- If your SD card does not have an "IC-7300" folder, back up any data on the SD card, insert it in the transceivers card slot and then format it using the built-in format function. See "Formatting an SD card" (p. 8-3) for details.
- Once the recording starts, it continues, even if the transceiver is turned OFF and ON again.
- The recording continues until you touch <<REC Stop>> or the free space on the SD card has run out.
- When the recording file's content becomes 2 GB, the transceiver continues to record, but to a new file.

TIP: When the PTT Automatic Recording function is set to ON in the Voice set mode, the recording automatically starts when you push [PTT]. (p. 6-8)

TIP: About recording

- After the recording starts, a folder and file are automatically created on the SD card.
 - ① The folder name is formatted yyyyymmdd (yyyy: year, mm: month, dd: day).
 - ① The file name is formatted yyyy-mm-dd hh:mm:ss (yyyy: year, mm: month, dd: day, hh: hour, mm: minute, ss: second).
 - ① The audio files recorded on the same day are saved in the same folder.
- While recording, ● is lit and  blinks.
- While standing by, the recording pauses.
- While pausing, || blinks.
- When you touch ●, "Stop recording?" is displayed.
 - ① If you touch [YES], the recording stops and the dialogue box disappears.
 - ① If you touch [NO], the dialogue box disappears and the recording continues.
- After the recording stops, ● turns OFF.

◇ Quick recording

You can quickly record receive audio.

1. Push **QUICK**.
 - Opens the QUICK MENU screen.
2. Touch "<<REC Start>>."

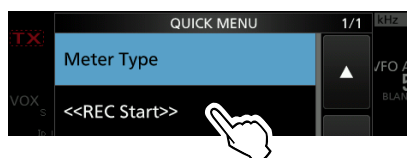

- Starts recording.
 - "Recording started." is briefly displayed.
3. Push **QUICK** again.
 - Opens the QUICK MENU screen.
 4. Touch "<<REC Stop>>."

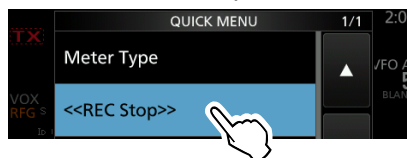

- Stops recording.
- "Recording stopped." is briefly displayed.

◇ Basic recording

You can record both receive and transmit audio.

1. Open the QSO RECORDER screen.
 - MENU** » **RECORD**
2. Touch "<<REC Start>>."



- Starts recording.
 - "Recording started." is briefly displayed.
3. Touch "<<REC Stop>>."



- Stops recording.
 - "Recording stopped." is briefly displayed.
4. To close the QSO RECORDER screen, push **EXIT**.

Playing back a QSO audio

You can playback the recorded QSO audio.

1. Open the PLAY FILES screen.
MENU » **RECORD > Play Files**
 - The folder list is displayed.
2. Touch the folder that the file you want to playback is saved.
 - ① The folder is named in the following manner, “yyyymmdd” (yyyy: Year, mm: month, dd: day).

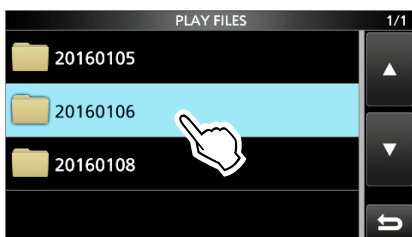

3. Touch the desired file.

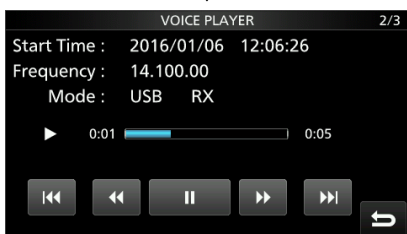
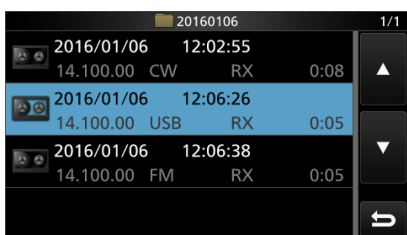

- Starts a playback.
 - ① Playback continues to the next file, and stops when the last file in the folder is played back.
4. To close the PLAY FILES screen, push **EXIT** several times.

Operation while playing back

You can fast forward or rewind while playing back. You can change the skip time in the PLAYER SET screen. (Default: 10 seconds)

MENU » **RECORD > Player Set > Skip Time**

◇ Fast forward while playing

Touch **▶▶** to fast forward to the skip time point. (Default: 10 seconds)

◇ Rewind while playing

Touch **◀◀** to rewind to the skip time point. (Default: 10 seconds)

① If you touch **◀◀** within the first 1 second of the file, at the end of the previously recorded file will play back.

◇ Pause while playing

Touch **⏸**.

① **▶** is displayed while pausing.

① To cancel the pausing, touch **▶**.

◇ Playing the previous file

Touch **◀◀** to play the previous file.

① If there are other files in the folder, while the oldest file is playing back, touch **◀◀** to start playing the beginning of the file.

◇ Playing the next file

Touch **▶▶** to play the next file.

① If there are other files in the folder, while the most recent file is playing back, touch **▶▶** to stop the playback.

◇ Moving to the beginning of the previous file

● While paused, touch **◀◀** to move to the beginning of the previous file.

① To playback the file, touch **▶**.

● While paused, touch **◀◀** to return to the beginning of the file.

① To playback the file, touch **▶**.

◇ Moving to the beginning of the next file

While paused, touch **▶▶** to move to the beginning of the next file.

① To playback the file, touch **▶**.

Operation while playing back

◇ VOICE PLAYER screen

Start Time
The recording start time of the file being played back.

The number of file
The number of the file being played back, and the total number of recorded files.

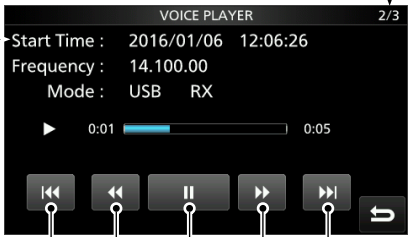

⏮️

Rewind

Play the previous file

⏸️

Pause

Touch to pause or playback

⏭️

Forward

Play the next file

Recording Information
Operating frequency, operating mode, and audio type: Receive (RX) or Transmit (TX).

Playback process
Displays progress of the file currently playing back.

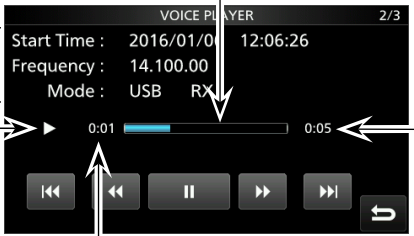

Playback icon
Displayed while playing back.
ⓘ Not displayed while paused.

Total time
The total time of the recorded file.

Checking the file information

The transceiver can display the recorded file's operating frequency, operating mode, date, and so on.

1. Open the PLAY FILES screen.
MENU » **RECORD > Play Files**
 - The folder list is displayed.
2. Select a folder that contains the file you want to playback.

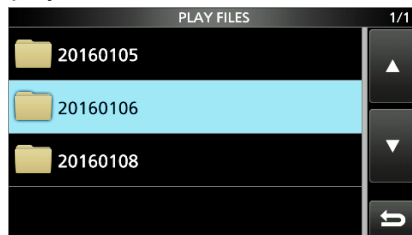

⊙MULTI

Rotate

⊙MULTI

Push

- The file list is displayed.
3. Touch the desired file to check for 1 second.

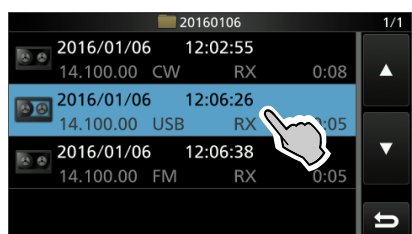

- Opens the QUICK MENU screen.
4. Touch "File Information."

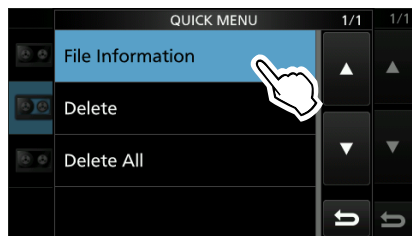
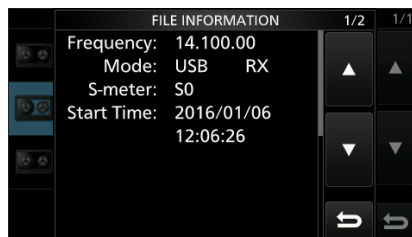



5. To close the PLAY FILES screen, push **EXIT** several times.

Checking the folder information

The transceiver can display the folder's name, number of the files in the folder, total capacity of the files and date.

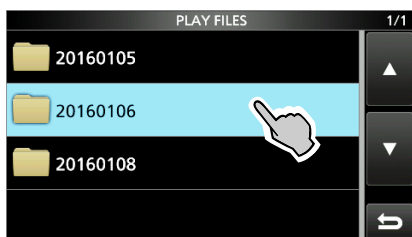
1. Open the PLAY FILES screen.
MENU » **RECORD > Play Files**
 - The folder list is displayed.
2. Touch the desired folder you want to check the contents of for 1 second.



- Opens the QUICK MENU screen.
3. Touch "Folder Information."

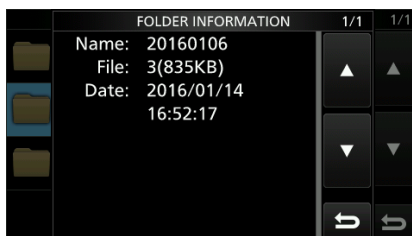
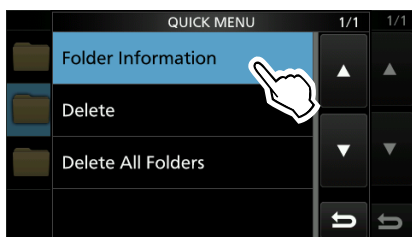

4. To close the PLAY FILES screen, push **EXIT** several times.

Deleting a file

You can delete the recorded audio file.

1. Open the PLAY FILES screen.
MENU » **RECORD > Play Files**
 - The folder list is displayed.
2. Touch a folder that contains the file you want to delete.

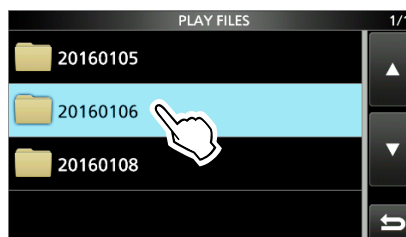

- The file list is displayed.
3. Touch the desired file to delete for 1 second.

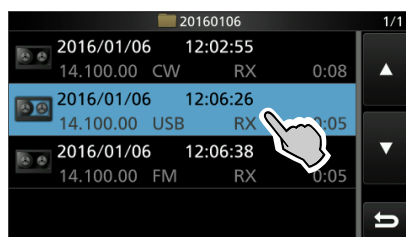

- Opens the QUICK MENU screen.
4. Touch "Delete."

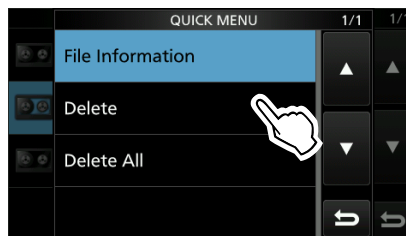

- "Delete file?" is displayed.
5. Touch [YES].

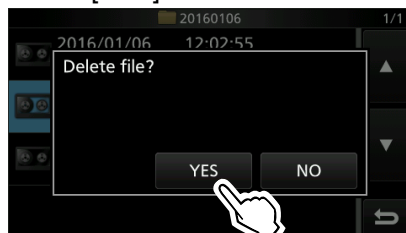

- The selected file is deleted.
6. To close the PLAY FILES screen, push **EXIT** several times.

◇ Deleting all files

If you want to delete all audio files in the folder at one time, select "Delete All" in step 4 above.

Deleting a folder

You can delete the recorded audio folders.

NOTE: All the files in the folder are also deleted.

1. Open the PLAY FILES screen.

MENU » **RECORD > Play Files**

- The folder list is displayed.

2. Touch the desired folder to delete for 1 second.

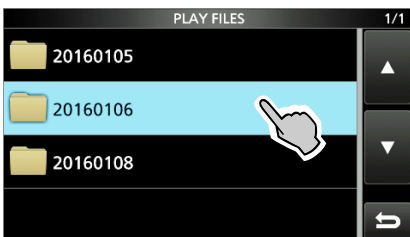

- Opens the QUICK MENU screen.

3. Touch "Delete."

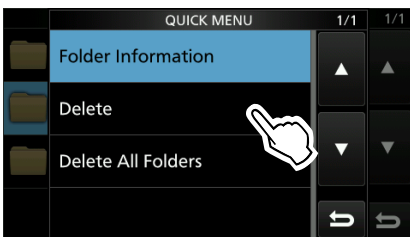

- "Delete folder?" is displayed.

4. Touch [YES].

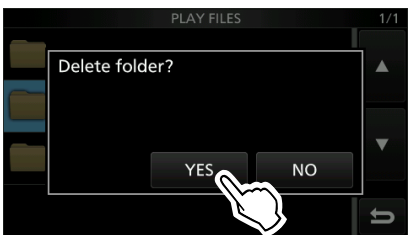

- The selected folder is deleted.

5. To close the PLAY FILES screen, push **EXIT** several times.

◇ Deleting all folders

If you want to delete all folders at one time, select "Delete All Folders" in step 3 above.

SD Card information

1. Open the SD CARD screen.

MENU » **SET > SD Card**

2. Select "SD Card Info."

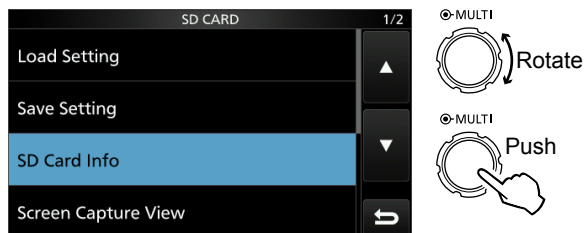

- The SD CARD INFO screen is displayed.

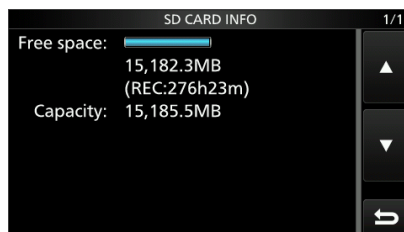

The SD CARD INFO screen

3. To close the SD CARD screen, push **EXIT** several times.

Playing back the recorded file on a PC

You can also playback the voice memory data on a PC.

- ① The recorded information (frequency, date, and so on) is not displayed.
- ① Microsoft Windows 10 is used for the description below.

1. Insert the SD card into your PC's SD card slot.
 - ① If your PC does not have an SD card drive, connect a memory card reader (user supplied) to the PC, and then insert the SD card into the reader.
2. Open the SD card folder view.
 - The "IC-7300" folder is displayed.
3. Double-click the "IC-7300" folder.

NOTE:

- The operations while playing back may differ, depending on the application. Refer to the application's instruction manual for details.
- When the file does not playback, even if you double click the file, download an appropriate software. (Example: Windows Media® Player)

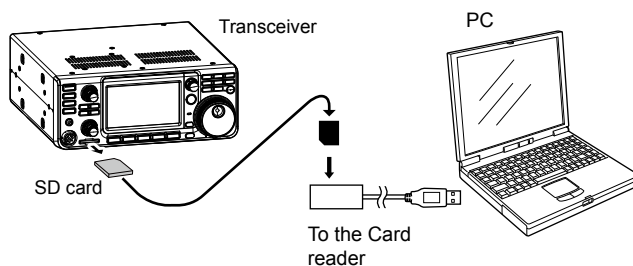

4. Double-click the "Voice" folder.
5. Double-click the folder where the file you want to playback is saved. (Example: 20160106 folder)
6. To playback the file, double-click it. (Example: 20160106_120255.wav)

The diagram illustrates the step-by-step navigation in Windows File Explorer to reach the audio file. It shows the path: USB Drive (F:) → IC-7300 → Voice → 20160106. In each screenshot, the folder or file being selected is highlighted with a black box, and an arrow points to it with the label "Double-click".

RECORDER SET screen

You can change the RECORDER SET settings. Details on each setting item are described below.

(Example: Setting the REC mode.)

1. Open the QSO RECORDER screen.

MENU » **RECORD**

2. Touch “Recorder Set.”

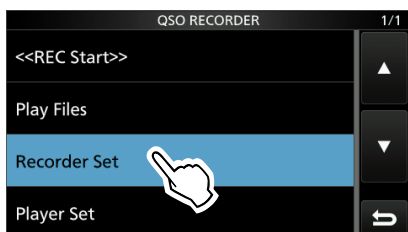

3. Select “REC Mode”.

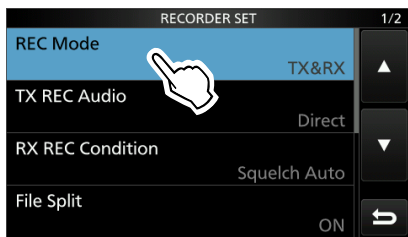

4. Select the REC mode “TX&RX” or “RX Only.”

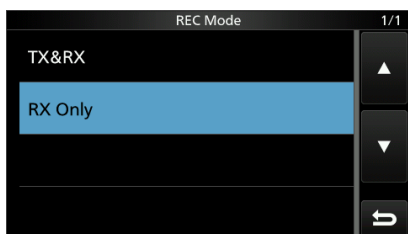

5. To close the RECORDER SET screen, push **EXIT** several times.

REC Mode (Default: TX&RX)

Select the recording mode to record a QSO audio.

- TX&RX: Records both the transmitted and received audio.
- RX Only: Records only the received audio.

TX REC Audio (Default: Direct)

Select the recording audio to transmit.

- Direct: Records the microphone audio.
- Monitor: Records the TX monitor audio.

RX REC Condition (Default: Squelch Auto)

Select the recording condition for receive.

- Always: Records even if no signal is received.
- Squelch Auto: Records only when the squelch opens.
(The recording will be paused when the squelch closes while recording.)

File Split (Default: ON)

Turn the File Split function ON or OFF.

- OFF: The audio is continuously recorded into the file even if you switch between transmit and receive or the squelch status changes between open and closed.
When the recording file’s size becomes 2 GB, the transceiver continues to record, but to a new file.
- ON: While recording, and if you switch between transmit and receive, or the squelch status changes between open and closed, a new file is automatically created in the same folder, and the audio is saved into the new one.

PTT Auto REC (Default: OFF)

Turn the PTT Automatic Recording function ON or OFF.

- OFF: The recording does not start, even if a signal is transmitted.
- ON: The recording automatically starts when a signal is transmitted.

The recording will stop when:

- 10 seconds has passed without transmission after the last transmission.
- 10 minutes has passed with no signal after the last transmission.
 - If you receive a signal within 10 seconds after the last transmission, the received audio is also recorded.
 - If you receive another signal within 10 seconds after the last reception, the received audio is also recorded.
- 10 minutes has past while operating with the squelch is open in the SSB, CW, RTTY, or AM mode.
- The frequency or operating mode is changed.
- The operating method (V/M, M-CH, Band Stacking Register, and so on) is changed.

PRE-REC for PTT Auto REC (Default: 10sec)

Select whether or not record the audio that is received before the PTT Automatic Recording function is activated.

- OFF: Does not record the audio.
- 5sec/10sec/15sec:
Records the audio that is previously received in this set period of time.

TIP: How to reset to the default setting

Touching the item or its option for 1 second displays the Quick menu, and then touch “Default” to reset to the default setting.

PLAYER SET screen

You can fast forward or rewind while playing back. You can change the skip time in the PLAYER SET screen.

1. Open the QSO RECORDER screen.

MENU » **RECORD**

2. Touch "Player Set."

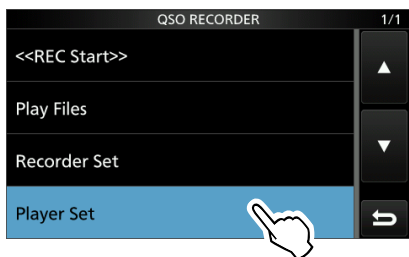

3. Select "Skip Time."

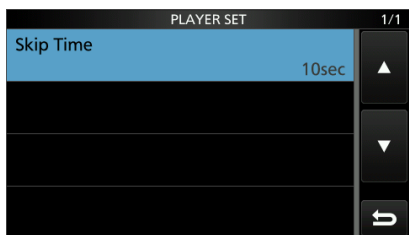

4. Select your desired option.
• Options: 3sec, 5sec, 10sec, or 30sec.



5. To close the RECORD screen, push **EXIT** several times.

TIP: How to reset to the default setting
Touching the item or its option for 1 second displays the Quick menu, and then touch "Default" to reset to the default setting.

Section 7

VOICE TX MEMORY OPERATION

Recording a Voice TX memory.....	7-2
◇ Recording	7-2
◇ Playing back	7-2
Entering a recording name	7-3
Transmitting a Voice memory content	7-4
◇ Transmitting	7-4
◇ Repeatedly transmitting	7-4
◇ Adjusting the output level.....	7-5
VOICE TX SET screen	7-6

Recording a Voice TX memory

You can record up to 8 Voice transmit memories of up to 1 and a half minutes in each memory.

To transmit recorded content using a Voice TX memory, first record the desired message, as described below.

- ① A user supplied SD card is required to use the Voice TX memory function.
- ① You can also transmit the recorded content using an external keypad (pp. 2-2, 12-10).

Recording

1. Open the VOICE TX screen in a Voice mode.

① (Voice mode: SSB, AM or FM modes).

MENU » **VOICE**

① You can select [VOICE] on the MENU screen only while in a Voice mode.

2. Touch [REC/SET].



• Opens the REC/SET screen.

3. Touch the “REC” item.

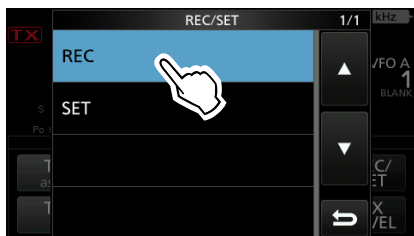

• Opens the VOICE TX RECORD screen.

4. Select the desired Voice memory “T1” ~ “T8.”

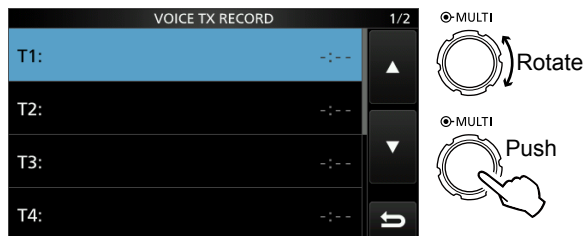

• Opens the selected Voice memory.

5. Touch to start recording.

Information

- You can record up to 1 and a half minutes in each memory.
- Without holding down [PTT], speak into the microphone at your normal voice level.
- Previously recorded content is overwritten.

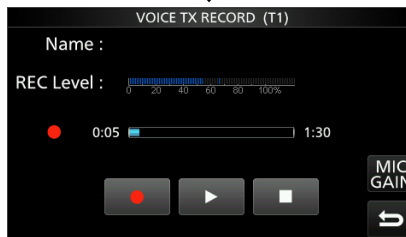

While Recording

Touch to open the MIC GAIN adjustment window

Displays the input audio level

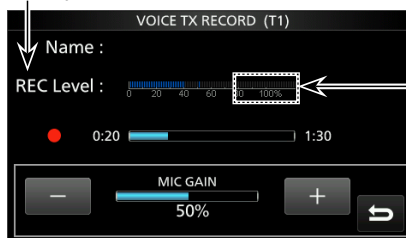

Adjust the Mic gain so that the “REC Level” meter does not reach 100%

6. Touch to stop recording.
7. To close the VOICE TX screen, push **EXIT** several times.

Playing back

1. Do steps 1 ~ 3 as described to the left to display the VOICE TX RECORD screen.
2. Rotate **(MULTI)** to select the desired Voice memory “T1” ~ “T8,” and then push **(MULTI)**.
3. Push to start the playback.
 - ① Playback is automatically terminated when all of the recorded content in the memory is played back.
 - ① To stop while playing back, touch .
4. To close the VOICE TX screen, push **EXIT** several times.

TIP: How to clear the recorded content
Touching the Voice memory for 1 second in step 4 above displays the Quick menu, and then touch “Clear.”

Entering a recording name

You can assign a name of up to 16 characters to each of the Voice memories “T1” ~ “T8.”

You can use upper case letters, lower case letters, numbers, some symbols and spaces.

[Example: Entering “Contest” in Memory T1]

1. Open the VOICE TX screen in a Voice mode.
①(Voice mode: SSB, AM or FM modes).



2. Touch [REC/SET].



- Opens the REC/SET screen.

3. Touch the “REC” item.

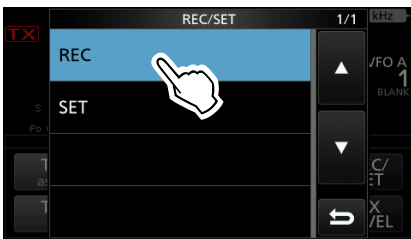

- Opens the VOICE TX RECORD screen.

4. Touch [▲] or [▼] to display the desired Voice memories “T1” ~ “T4” or “T5” ~ “T8,” and then touch the memory for 1 second.

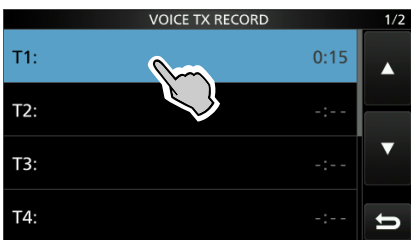

- Opens the QUICK MENU screen.

5. Touch “Edit Name.”

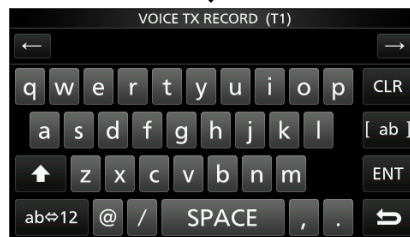

- Opens the Name editing screen.

6. Enter a name of up to 16 characters.
①See “Keyboard entering and editing” (p. 1-9) for details.

7. Touch [ENT] to save the entered name.

- The Name editing screen closes and returns to the VOICE TX RECORD screen.
- The entered name is displayed.

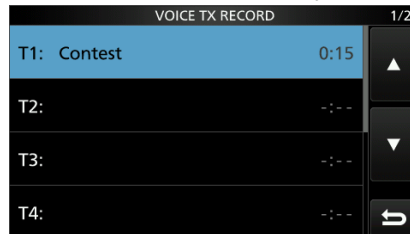

8. To close the VOICE TX RECORD screen, push **EXIT**.



- ①The memory name is also displayed on the VOICE TX screen.

Transmitting a Voice memory content

You can transmit the Voice TX memory contents once or repeatedly. This is useful for transmitting your call sign and contest name in some contests, or repeatedly calling CQ.

◇ Transmitting

Transmits the prerecorded content. (p. 6-2)

1. Open the VOICE TX screen in a Voice mode.
①(Voice mode: SSB, AM or FM modes).

MENU » **VOICE**

2. Touch the desired Voice memory key [T1] ~ [T8].



This icon blinks while transmitting.

- Transmits the recorded content once.

① Information

- The transceiver automatically transmits.
- The Memory Timer counts down.
- The transceiver automatically returns to receive when all of the recorded content in the memory is transmitted.

3. To close the VOICE TX screen, push **EXIT**.

TIP: How to cancel a Voice TX transmission

- Touch any keys other than [TX LEVEL] on the VOICE TX screen
 - Push **EXIT**, **V/M**, **▲**, or **▼**
 - Touch the frequency's MHz digits or the Memory channel number
 - Turn OFF the transceiver
- ①When "PTT Port Function" is set to "PTT Input," you can cancel transmitting the recorded audio by pushing [PTT] on the microphone.

When an external keypad is connected:

You can transmit the preset contents in the Voice TX memory (T1 ~ T4) from an external device by setting the "External Keypad," and then connecting an external keypad to [MIC] on the IC-7300.

①Memory "T5 ~ T8" cannot be sent from the external keypad.

MENU » **SET > Connectors > External Keypad > VOICE**

◇ Repeatedly transmitting

1. Open the VOICE TX screen in a Voice mode.
①(Voice mode: SSB, AM or FM modes).

MENU » **VOICE**

2. Touch the desired Voice memory key [T1] ~ [T8] for 1 second.



This icon blinks while transmitting.

- Repeatedly transmits the recorded content.

① Information

- The transceiver automatically transmits.
- The Memory Timer counts down.
-  is displayed while repeatedly transmitting.
- Repeatedly transmits the recorded content for up to 10 minutes, at the interval specified in the "Repeat Time" item of the VOICE TX SET screen (p. 7-6).
- After 10 minutes have passed, and all of the recorded content in the memory is transmitted, the transceiver automatically returns to receive .
- When a signal is received while in the transmit interval, the transceiver pauses the next transmission until the signal disappears. However, if the squelch is set to open, the transceiver repeatedly transmits following the repeat interval even signals are received.

3. To close the VOICE TX screen, push **EXIT**.

TIP:

- When an external keypad (pp. 2-2, 12-10) is connected, you can transmit the recorded content.
- When pushing one of [S1] to [S4] on the external keypad, the recorded content in T1 to T4 is transmitted once.
 - When holding down a key for 1 second, the recorded content is repeatedly transmitted.

7 VOICE TX MEMORY OPERATION

Transmitting a Voice TX memory (Continue)

◇ Adjusting the output level

Adjusts the Transmit voice level.

1. Open the VOICE TX screen in a Voice mode.
① (Voice mode: SSB, AM or FM modes).

MENU » **VOICE**

2. Touch [TX LEVEL].

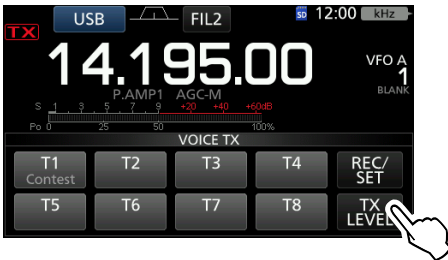

- Opens the “TX LEVEL” window.
3. Touch any desired Voice memory key other than [T4] or [T8]. ([T1], [T2], [T3], [T5], [T6] or [T7])
 - The transceiver automatically transmits.
 - ① To adjust the Transmit voice level using [T4] or [T8], reverse steps 2 and 3 .
 4. While transmitting, rotate **MAIN DIAL** to adjust the transmit voice level.

Touch for 1 second to
reset to the default setting



Rotate **MAIN DIAL**

- ① The transceiver automatically returns to receive when all of the recorded content in the memory is transmitted.
 - ① Adjusting TX LEVEL too high may result in an over modulation and transmit signal distortion.
5. To close the VOICE TX screen, push **EXIT** several times.

TIP: How to cancel a Voice TX transmission

- Touch any keys other than [TX LEVEL] on the VOICE TX screen
- Push **EXIT**, **V/M**, **▲**, or **▼**
- Touch the frequency's MHz digits or the Memory channel number
- Turn OFF the transceiver

VOICE TX SET screen

This Set screen is used to set the Automatic Monitor function and the Transmit Repeat Interval.

1. Open the VOICE TX screen in a Voice mode.
 ①(Voice mode: SSB, AM or FM modes).

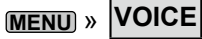

2. Touch [REC/SET].



- Opens the REC/SET screen.

3. Touch the “SET” item.



- Opens the VOICE TX SET screen.

4. Touch the desired item.

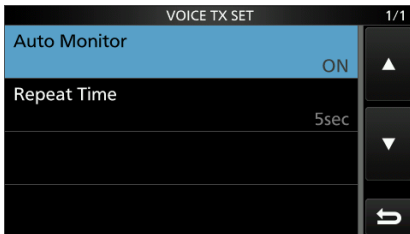

5. Select the option or set the time.

- ①See to the upper right for details of the setting items and their options.

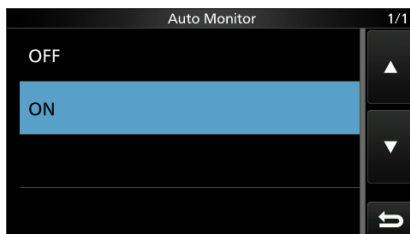

6. To close the VOICE TX screen, push [EXIT] several times.

Auto Monitor (Default: ON)

Turn the Automatic Monitor function for recorded audio contents transmission, ON or OFF.

- ON: Automatically monitors transmit audio when sending a recorded audio.
- OFF: Monitors transmit audio only when the Monitor function is ON.

Repeat Time (Default: 5 sec)

Set the repeat interval to repeat the voice transmission.

The transceiver repeatedly transmits the recorded content at this interval.

- ①Repeatedly transmits the recorded content for up to 10 minutes.
- ①After 10 minutes have passed, and all of the recorded content in the memory is transmitted, the transceiver automatically returns to receive.
- Range: Between 1 and 15 seconds

TIP: How to reset to the default setting

Touching the item or its option for 1 second displays the Quick menu, and then touch “Default” to reset to the default setting.

About the SD card	8-2
Saving data onto the SD card.....	8-2
Inserting or removing the SD card.....	8-2
◇ Inserting	8-2
◇ Removing.....	8-2
Unmounting an SD card	8-3
Formatting an SD card	8-3
Saving the setting data onto an SD card.....	8-4
◇ Saving in the old firmware format	8-4
◇ Saving with a different file name	8-5
Loading the saved data files onto an SD card.....	8-6
Deleting a data file.....	8-7
Displaying the information	8-7
Backing up the data saved on the SD card onto a PC	8-8
◇ About the SD card's folder contents	8-8
◇ Making a backup file on your PC	8-9

About the SD card

The SD and SDHC cards are not supplied by Icom. User supplied.

You can use an SD card of up to 2 GB, or an SDHC of up to 32 GB. Icom has checked the compatibility with the following SD and SDHC cards.

(As of August 2024)

Brand	Type	Memory size
SanDisk®	SD	2 GB
	SDHC	4 GB
		8 GB
		16 GB
		32 GB

- ① The above list does not guarantee the card's performance.
- ① Throughout the rest of this document, the SD card and an SDHC card are simply called the SD card or the card.

TIP: Icom recommends that you save the transceiver's factory default data for backup. (p. 8-4)

NOTE:

- Before using the SD card, thoroughly read the card's instructions.
- If you do any of the following, the card data may be corrupted or deleted.
 - You remove the card from the transceiver while the card is being accessed.
 - A power failure occurs or the power cable is disconnected while the card is being accessed.
 - You drop, impact or vibrate the card.
- Do not touch the contacts of the card.
- The transceiver takes a longer time to recognize a high capacity card.
- The card will get warm if continuously used for a long period of time.
- The card has a certain lifetime, so data reading or writing may not be possible after using it for a long period. When reading or writing data is impossible, the card's lifetime has ended. In that case, use a new one. We recommend you make a separate backup file of the important data onto your PC. (p. 8-8)
- Icom will not be responsible for any damage caused by data corruption of a card.

Saving data onto the SD card

- You can save the following data onto the card:
- Data settings of the transceiver
 - Memory channel and Preset memory contents saved in the transceiver.
 - Communication content
 - The transmitted and received audio.
 - Communication log
 - The communication and receive history log.
 - Voice audio for the Voice TX function
 - Voice audio to use with the Voice TX function.
 - RTTY decode log
 - The transmitted or received RTTY decode history log.
 - Captured screens

Inserting or removing the SD card

NOTE: Format all SD cards to be used with the transceiver with the built-in Format function. Format, even preformatted cards for PCs or other uses. (p. 8-3)

◇ Inserting

- Insert the card into the slot until it locks in place, and makes a 'click' sound.
- Displays the SD card icon when the SD card is inserted.
 - ① Be sure to check the card orientation.

◇ Removing

- Push in the SD card until a click sounds.
- The card is unlocked, and you can pull it out.
 - ① If you remove the SD card while the transceiver's power is ON, be sure to unmount it. (p. 8-3)

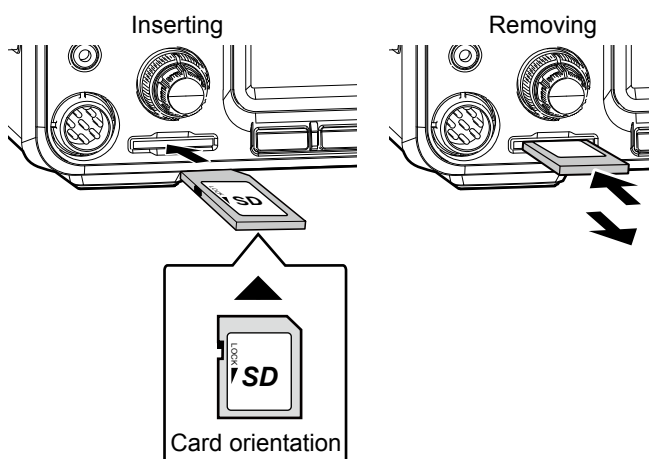

Unmounting an SD card

Before you remove a card when the transceiver is ON, be sure to electrically unmount it, as shown below. Otherwise the data may be corrupted or deleted.

1. Open the SD CARD set screen.

MENU » **SET > SD Card**

2. Select “Unmount.”

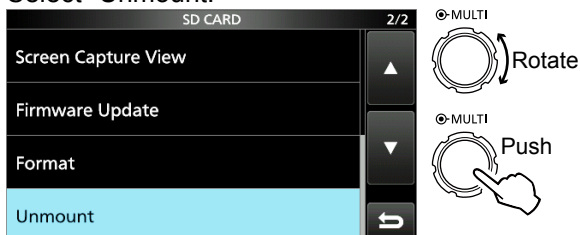

SD CARD set screen

3. Touch [YES] to unmount.
 Ⓜ To cancel unmounting, touch [NO].

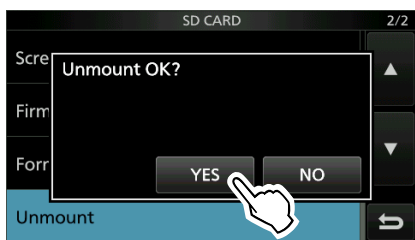

• After unmounting, returns to the SD CARD set screen.

4. To close the SET screen, push **EXIT** several times.
5. Remove the card from the transceiver.

Formatting an SD card

Before using an SD card with the transceiver, be sure to format all SD cards with the built-in Format function. This creates a special folder on the card that you need for operations like updating the firmware. Format all cards, including a brand new SD card, and even preformatted cards for PCs or other uses.

NOTE: Formatting a card erases all its data. Before formatting any used card, back up its data onto your PC. (p. 8-8)

IMPORTANT: Even if you format an SD card, some data may remain in the card. When you dispose the card, be sure to physically destroy it to avoid unauthorized access to any data that remains.

1. Insert an SD card into the card slot.
2. Open the SD CARD set screen.

MENU » **SET > SD Card**

3. Select “Format.”

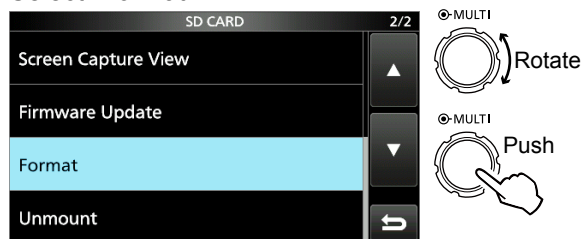

SD CARD set screen

4. Touch [YES] to start formatting.
 Ⓜ To cancel formatting, touch [NO].

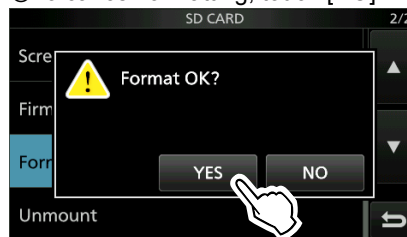

• After formatting, returns to the SD CARD set screen.

5. To close the SET screen, push **EXIT** several times.

Saving the setting data onto an SD card

You can save the Memory channels and the transceiver's settings onto a card.

This function is convenient when:

- Copying the saved data to another IC-7300 to operate with the same data.
- Using one IC-7300 by two or more operators with their own individual data.

1. Insert an SD card into the card slot.
2. Open the SAVE SETTING screen.

MENU » **SET > SD Card > Save Setting**

3. Select "<<New File>>."

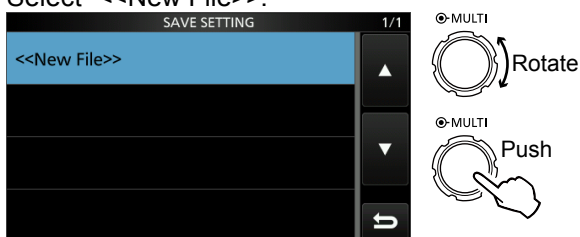

SAVE SETTING screen

① The file name is automatically set in the following format: Setyyyyymmdd_xx (yyyy: Year, mm: month, dd: day, xx: serial number)

① If you want to change the file name, see "Saving with a different file name." (p. 8-5)

TIP: After you update the transceiver's firmware, the "Save Form" item will be added on the SD CARD set screen. If this item is set to the earlier firmware version, the confirmation window is displayed after step 3. When you save the data in the earlier firmware version, touch [YES].

4. Touch [ENT].



5. Touch [YES].

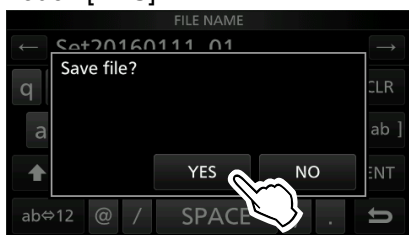

- Saves the data settings.

① While saving to the card, the SD card icon blinks.

① After saving, returns to the SD CARD set screen.

6. To close the SET screen, push **EXIT** several times.

TIP: To overwrite the setting data, select the desired file in step 2.

◇ Saving in the old firmware format

After you update the transceiver's firmware, the "Save Form" item will be added on the SD CARD set screen.

With this item, you can select the firmware version to save the setting data onto an SD card.

You can write the setting file that is saved in an earlier version to an earlier firmware version IC-7300.

MENU » **SET > SD Card > Save Form**

① Depending on the transceiver's firmware version, this item may not be displayed. In that case, save the file in the current version.

① See page 15-2 for details of the firmware update.

NOTE:

- If you select "Old Ver (xxx - xxx)," a function that is added when the transceiver's firmware format is updated will not be saved.

- You cannot load a setting file that is saved in the current version format to an earlier firmware version IC-7300.

Saving the setting data onto an SD card

◇ Saving with a different file name

You can change the file name to one of up to 15 characters. You can use upper case letters, lower case letters, numbers, some symbols and spaces.

*You cannot enter symbols: \ / : ; * ? " < > |

If you enter those symbols, an error message is displayed and you cannot save the file.

(Example: Changing a file name to "My data.")

1. Open the SAVE SETTING screen.

MENU » **SET > SD Card > Save Setting**

2. Select "<<New File>>."

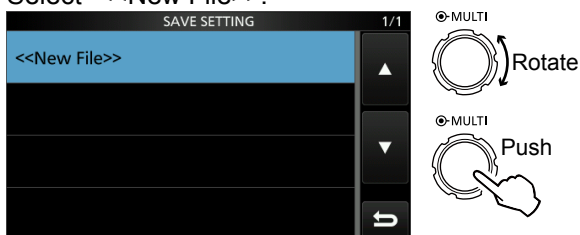

SAVE SETTING screen

3. Touch [CLR] to delete the previously entered character.
 - ① If you continuously touch [CLR], all the characters are deleted.



• The character to the left of the cursor is deleted.

4. Touch the keyboard to enter a desired name, and then touch [ENT].
 - ① See "Keyboard entering and editing" (p. 1-9) for details.

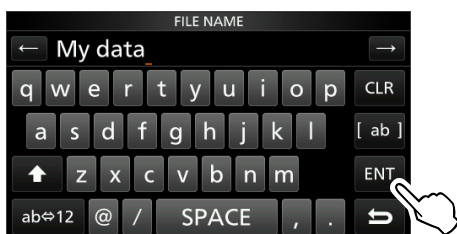

5. Touch [YES].

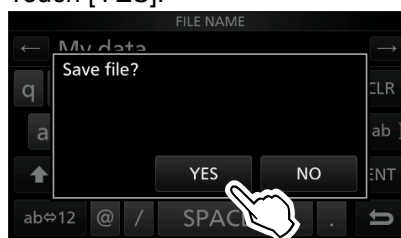

• Saves the data settings.

① While saving, the SD card icon blinks.

① After saving, automatically returns to the SD CARD set screen.

6. To close the SET screen, push **EXIT** several times.

Loading the saved data files onto an SD card

You can load the Memory channels and transceiver's settings from the card to the transceiver.

This function is convenient when:

- Copying the saved data to another IC-7300 to operate with the same data.
- Using one IC-7300 by two or more operators with their own individual data.

① The transceiver has "ALL" and "Select" loading options to choose from.

TIP: Saving the current data is recommended before loading other data into the transceiver.

(Example: Loading the selected data)

1. Open the LOAD SETTING screen.

MENU » **SET > SD Card > Load Setting**

2. Select the desired file to be loaded.

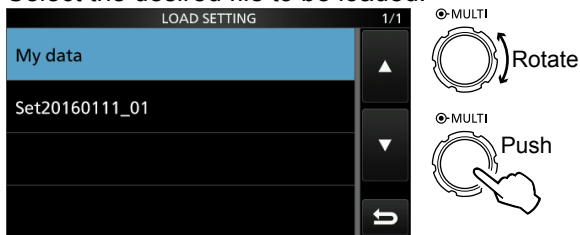

LOAD SETTING screen

3. Select "Select."

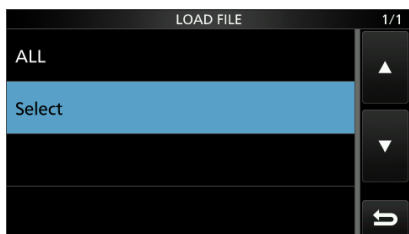

4. Touch the desired loading option.

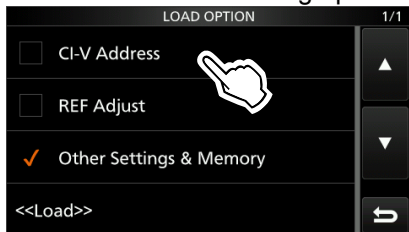

- "✓" is displayed left side of the selected option.
- ① The Set mode settings and Memory channel contents are always loaded.

5. Touch "<<Load>>."

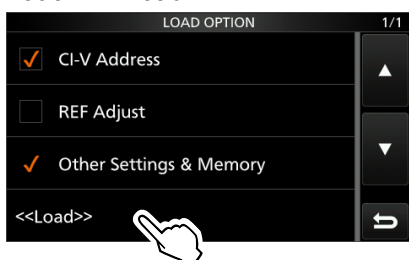

6. Touch [YES].

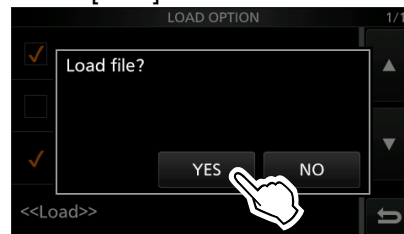

- Starts the file check.
 - ① While checking the file, "Checking the file." and a progress bar are displayed.
 - ① When you select "REF Adjust" in step 4, "The new "REF Adjust" setting will be saved" is displayed.
7. After checking, the file loading starts.
- While loading, "LOADING" and a progress bar are displayed.
8. After loading ends, "Restart the IC-7300" is displayed.
- Turn the transceiver power OFF, then ON again to restart the transceiver.

TIP: When you select "ALL" in step 3, the following contents are loaded.

- CI-V Address
- Setting of the "REF Adjust" item in the Set mode.
- Set mode settings and Memory channel contents

Deleting a data file

Deleting an unnecessary data file shortens the period of time needed to recognize the SD card.

NOTE: Deleted data from a card cannot be recalled. Before deleting any data, back up the card data onto your PC.

1. Open the SAVE SETTING screen.
MENU » **SET > SD Card > Save Setting**
2. Touch the desired file to be deleted for 1 second.

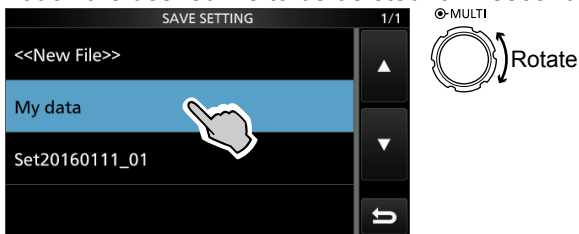

SAVE SETTING screen

3. Touch "Delete."
 ① To delete all files, touch "Delete All."
 ② To cancel deleting, push **EXIT**.

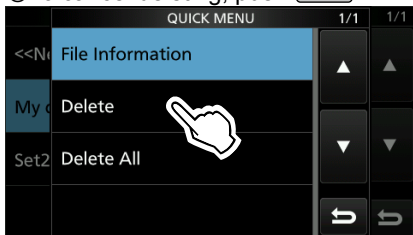

• Opens the confirmation window.

4. Touch [YES].

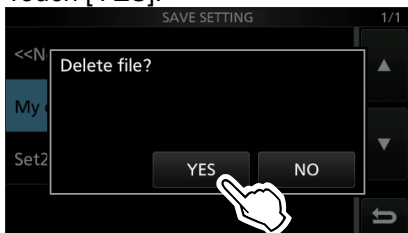

• Deletes the selected file.
 ① After deleting, returns to the SAVE SETTING screen.

5. To close the SET screen, push **EXIT** several times.

Displaying the information

You can display the SD card capacity and the time remaining for voice recording.

1. Open the SD CARD set screen.

MENU » **SET > SD Card**

2. Select "SD Card Info."

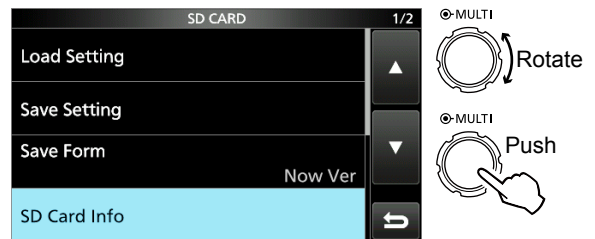

SD CARD set screen

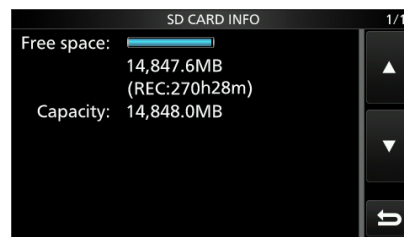

SD CARD INFO screen

• Opens the SD CARD INFO screen.

3. To close the SET screen, push **EXIT** several times.

Backing up the data saved on the SD card onto a PC

You can easily restore data with a backup file even if the setting data in the SD card is accidentally deleted.

◇ About the SD card's folder contents

The folder in the SD card contains the following:

1. IC-7300 folder
The folders created in the IC-7300 are contained in this folder.
2. Capture folder
The captured screen data is saved in the 'png' or 'bmp' format.
3. Decode folder
The RTTY decode log folder is created.
4. RTTY folder
The transmitted or received RTTY decode log data is saved in the 'txt' format*.
*You can change the file format to 'html' in the RTTY DECODE LOG SET screen. (p. 4-27)
5. Setting folder
The transceiver's setting data is saved in the 'dat' format.
6. Voice folder
The recorded QSO audio data folders are created.
7. yyyyymmdd folder
Recorded audio files are saved in the 'wav' format. The folder name is automatically created in the following format: yyyyymmdd (yyyy:Year, mm:month, dd:day)
8. VoiceTx folder
Recorded voice audio data for the Voice TX function is saved in the 'wav' format.

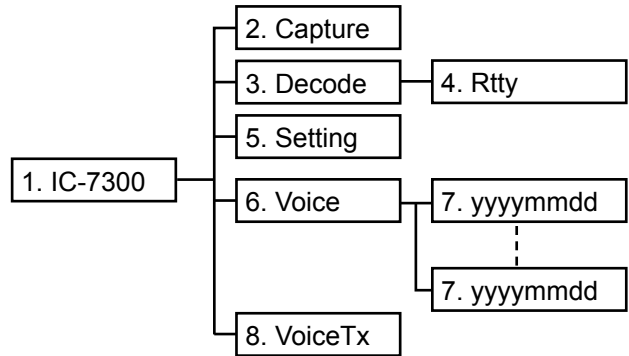

(Example: Selecting the setting data)
When the PC reads the SD card data, the screens shown below are displayed.

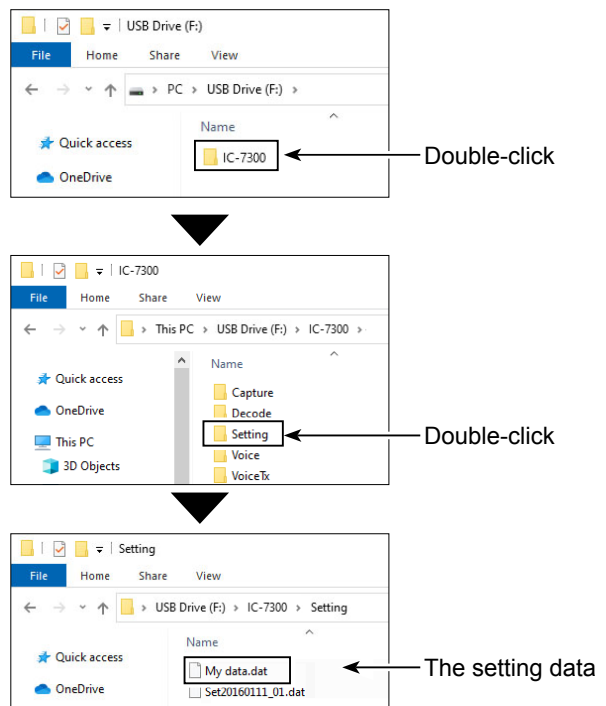

8 USING AN SD CARD

Backing up the data saved on the SD card onto a PC

◇ Making a backup file on your PC

Windows 10 is used for these instructions.

1. Insert the SD card into the SD card drive or a memory card reader* on your PC.
*User supplied.

2. Click the SD card drive
 - Displays the IC-7300 folder.

3. Right-click “USB drive,” and then click “Copy.”

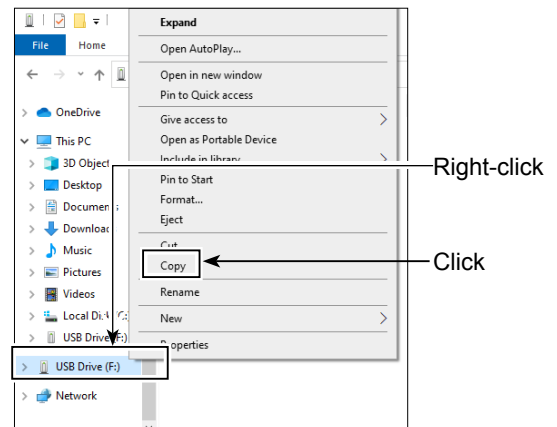

4. Open the desired folder to make a backup file, and then, right-click on the folder. Then, click “Paste.”
 - Pastes the copied SD card data onto the hard disk. (Example: Pasting into the “Backup” folder in the C drive)

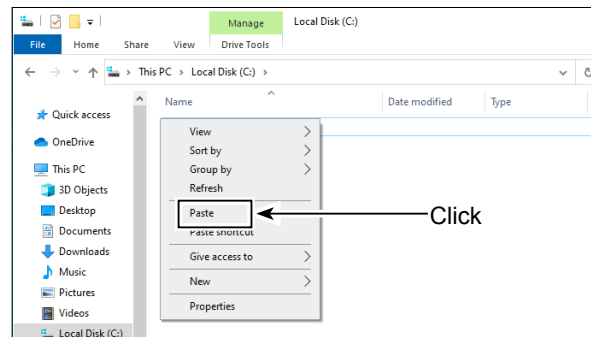

5. When removing the SD card from your PC, be sure to safely remove it.
①The screen shot shows when a memory card reader is inserted.
6. After “Safe To Remove Hardware” is displayed, remove the SD card from your PC.

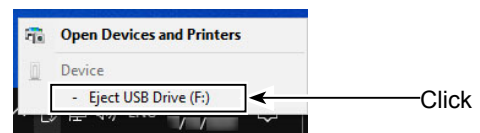

- Memory channels 9-2
- Selecting a memory channel 9-2
 - ◇ Selecting with the up and down keys..... 9-2
 - ◇ Selecting using the keypad..... 9-2
 - ◇ Selecting in the MEMORY screen 9-3
- Entering memory channel contents 9-3
 - ◇ Entering in the VFO mode 9-3
 - ◇ Entering in the Memory mode..... 9-3
- Clearing a memory channel..... 9-4
- Copying the Memory channel contents 9-4
 - ◇ Copying to the other memory channel..... 9-4
 - ◇ Copying to the VFO 9-4
- Entering a memory name 9-5
- About the MEMORY screen 9-5
- Memo Pad 9-6
 - ◇ Saving the displayed contents into a Memo Pad 9-6
 - ◇ Calling up the Memo Pads..... 9-6
 - ◇ Using the Memo Pad list..... 9-6

Memory channels

The transceiver has 101 memory channels. The Memory mode enables you to quickly select often-used frequencies.

You can temporarily tune all 101 memory channel frequencies by rotating **(MAIN DIAL)**.

Memory channel	Memory channel number	Capability	Transfer to VFO	Over-writing	Clear
Regular memory channels	1 to 99	1 frequency and 1 mode in each memory channel.	Yes	Yes	Yes
Scan Edge memory channels	P1 and P2	1 frequency and 1 mode in each memory channel as scan edges for programmed scans.	Yes	Yes	No

Selecting a memory channel

◇ Selecting with the up and down keys

1. Push **[V/M]** to select the Memory mode.
2. Push **[▲]** or **[▼]** to select the desired memory channel.
 - ① You can also select the memory channel with the microphone **[UP]** and **[DN]** keys.

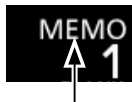

Memory mode
(Example: Memory channel 1)

3. To return to the VFO mode, push **[V/M]** again.

◇ Selecting using the keypad

1. Push **[V/M]** to select the Memory mode.
2. Touch the MHz digit on the operating frequency.
 - The BAND STACKING REGISTER screen is displayed.



3. Touch **[F-INP]**.
 - The F-INP screen is displayed.



4. Enter the desired memory channel number.
(Example: memory channel 2)



5. Touch **[MEMO]** to set the entered memory channel.

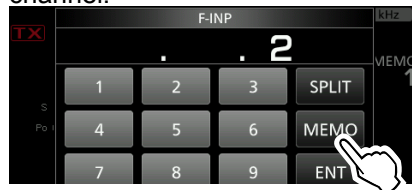



Memory channel 2 is selected

9 MEMORY OPERATION

Memory channel selection (Continue)

◇ Selecting in the MEMORY screen

- Open the MEMORY screen.
 » 
- Select the desired memory channel by rotating and then pushing .
 (Example: memory channel 2)

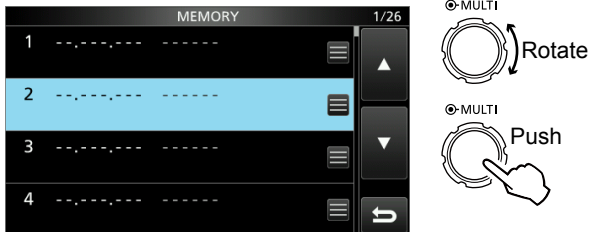



Memory channel 2 is selected

Entering memory channel contents

You can enter memory channel contents in either the VFO mode or the Memory mode.

◇ Entering in the VFO mode

[Example: Entering 7.088 MHz, LSB, into memory channel 2]

- Push  to select the VFO mode.
 - “VFO A” or “VFO B” is displayed.
- Set the frequency, operating mode and filter.
- Push  or  to select the channel to enter.
 - “BLANK” is displayed if the selected channel has no contents.
 - ① If the selected channel was previously entered, the contents will be overwritten.
- Touch the channel number.
 - ① You cannot touch the channel number when the Mini scope screen or expanded screen is displayed.
 - The VFO/MEMORY screen is displayed.

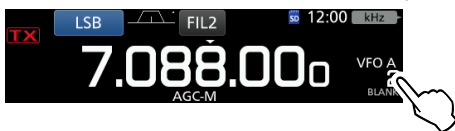



- Touch [MW] for 1 second to save the entered contents into the selected channel.
 - “BLANK” disappears or the selected channel's contents are overwritten.



◇ Entering in the Memory mode

[Example: Entering 21.280 MHz, USB, into memory channel 3]

- Push  to select the Memory mode.
- Push  or  to select the channel to enter.
 - “BLANK” is displayed if the selected memory channel has no contents.
 - ① If the selected channel is previously entered, the contents will be overwritten.
- Set the desired frequency, operating mode, and filter. (p. 3-3)



- Touch the channel number.
 - The VFO/MEMORY screen is displayed.

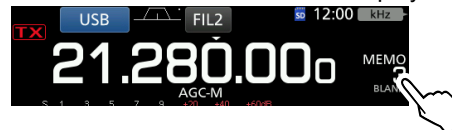

- Touch [MW] for 1 second to save the entered contents into the selected channel.
 - “BLANK” disappears or the selected channel's contents are overwritten.

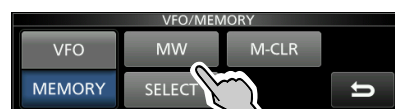

Clearing a memory channel

You can clear any no-longer-used memory channel and set it as a blank channel.

[Example: Clearing Memory channel 3]

1. Push **[V/M]** to select the Memory mode.
2. Push **[▲]** or **[▼]** to select the channel to clear.
3. Touch the channel number.
 - The VFO/MEMORY screen is displayed.

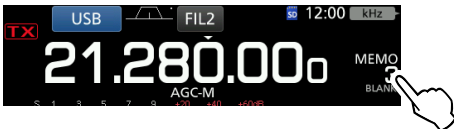

4. Touch **[M-CLR]** for 1 second to clear the memory channel.
 - “BLANK” is displayed.



Copying the Memory channel contents

You can copy a Memory channel contents to the VFO or another memory channel.

◇ Copying to the other memory channel

You can copy the Memory contents to another memory channel.

[Example: Copying the contents of Memory channel 1 to the Memory channel 2]

1. Push **[V/M]** to select the Memory mode.
2. Push **[▲]** or **[▼]** to select the channel to be copied. (Example: memory channel 1)
3. Open the MEMORY screen.
 - [MENU] » [MEMORY]**
4. Select the desired memory channel to be overwritten (Example: memory channel 2), and then touch **[≡]**.
 - The MEMORY MENU is displayed.

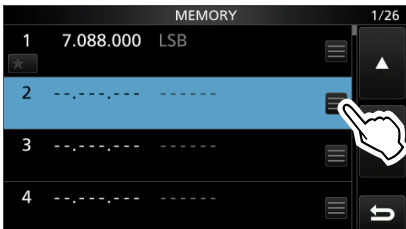

5. Select “Memory Write.”

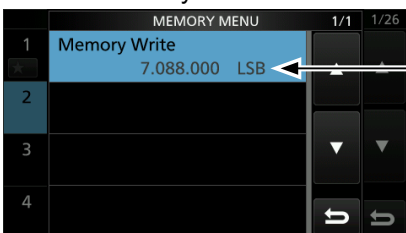

The contents of Memory channel 1

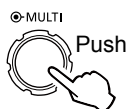
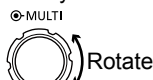

6. Touch **[Yes]**.
 - A beep sounds and the selected memory contents are copied.
 - Returns to the MEMORY screen.

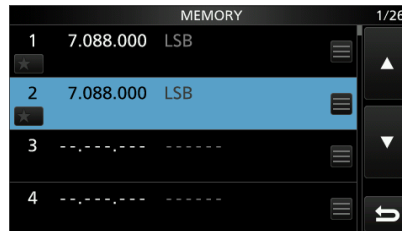

◇ Copying to the VFO

You can copy the Memory contents to the VFO.

[Example: Copying the contents of Memory channel 1 to the VFO]

1. Push **[V/M]** to select the Memory mode.
2. Push **[▲]** or **[▼]** to select the channel to be copied. (Example: memory channel 1)

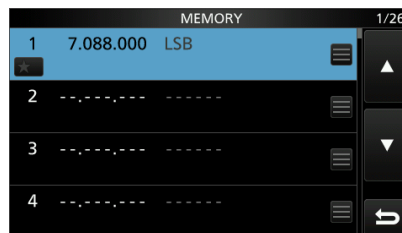

3. Hold down **[V/M]** for 1 second.
 - A beep sounds and the selected memory contents are copied to the VFO.

Entering a memory name

You can assign a name of up to 10 characters to all memory channels, including scan edges.

You can use upper case letters, lower case letters, numbers, some symbols and spaces.

The names you enter will be displayed along with the memory channel contents.

[Example: Entering "Icom 01" in Memory channel 2]

1. Open the MEMORY screen.

MENU » **MEMORY**

2. Select the desired memory channel to enter a name.

① You can only select a channel with memory contents.

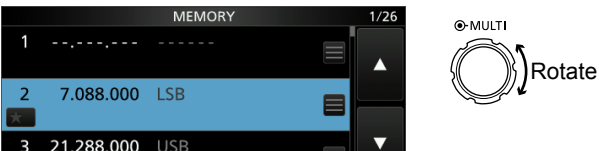

3. While Memory channel 2 is selected, touch **QUICK**.

• The QUICK MENU screen is displayed.

4. Select "Edit Name."

• The "MEMORY NAME" editing screen is displayed.

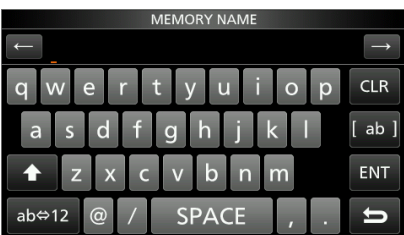
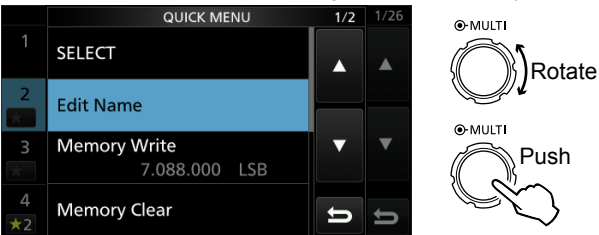

5. Enter a name of up to 10 characters.

① See "Keyboard entering and editing" (p. 1-9) for details.

6. Touch [ENT] to save the entered name.

• The MEMORY NAME screen closes and returns to the MEMORY screen.
• The entered name is displayed.

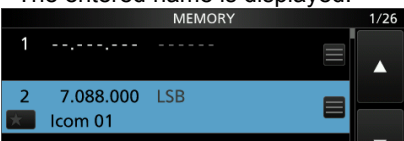

① The memory name is also displayed on the Standby mode screen.



About the MEMORY screen

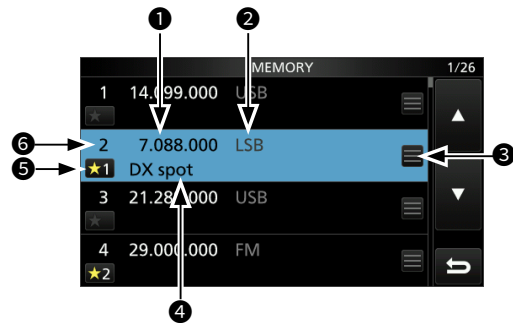

1 Frequency

Displays the entered frequency.

2 Operating mode

Displays the selected operating mode.

3 Memory menu

Touch to display the MEMORY MENU.

① You can select between "Edit Name," "Memory Write" and "Memory Clear" is selectable.

4 Memory name

Displays the memory name, if entered.

① See the left column for details.

5 Select memory icon

Touch this icon to set the select number "★1," "★2," "★3" or OFF.

① You can also touch the icon for 1 second to display the SELECT ALL CLEAR screen, and then select the desired item to reset the select number.

6 Memory channel number

Displays the memory channel number.

① "P1" or "P2" is displayed for the Scan Edge memory channels.

Memo Pad

There are 5 Memo Pads as the default to save frequencies and operating modes for easy write and recall. You can increase the Memo Pads to 10 in “Memopad Numbers” (p. 12-6).

MENU » **SET > Function > Memo Pad Quantity**

① The Memo Pads are separate from memory channels.

◇ Saving the displayed contents into a Memo Pad

Save the displayed content by touching **MPAD** for 1 second.

① When you save the 6th Memo Pad, the oldest Memo Pad is automatically cleared to make room for the new Memo Pad.

NOTE:

Each Memo Pad must have its own unique contents. The Memo Pads with identical content cannot be saved.



Operating frequency of the VFO mode or Memory mode

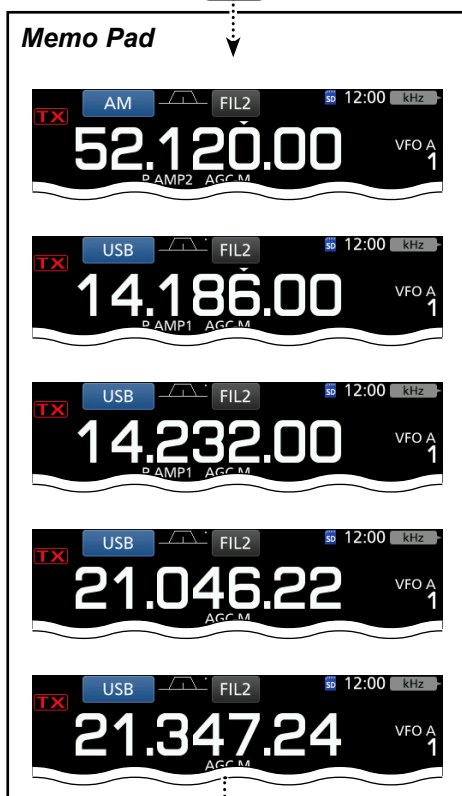

Newest Pad

Oldest Pad

Cleared

Memo Pads are convenient when you want to temporarily memorize a frequency and operating mode, such as when you find a DX station in a pile-up, or when the desired station is busy for a long time and you want to temporarily search for other stations. You can use the Memo Pads in both the VFO and Memory modes. Use Memo Pads instead of relying on hastily scribbled notes that are easily misplaced.

◇ Calling up the Memo Pads

You can call up the saved Memo Pads. Push **MPAD** several times until the desired Pad is displayed.

① The calling up starts with the most recently saved contents.

TIP: When you call up a Memo Pad, the contents that were previously displayed is automatically saved in a temporary pad. You can recall the temporary pad by pushing **MPAD** several times until the desired Pad is displayed.

• You may think there are 6 Memo Pads because 6 different frequencies are called up. However, 5 are in Memo Pads and 1 is in a temporary pad).

◇ Using the Memo Pad list

1. Open the MEMO PAD list screen.
MENU » **MPAD**
2. Touch **[▲]** or **[▼]** to select the desired Memo Pad.
① Touch **[DEL]** for 1 second to delete the selected Memo Pad.
① Touch **[DEL ALL]** for 1 second to delete all the Memo Pads.
3. Touch **[EXIT]** to close the MEMO PAD list screen.



TIP: If you change the frequency or operating mode called up from Memo Pads, the contents are automatically updated in a temporary Pad.

Section 10 SCANS

Scan types.....	10-2
Preparation.....	10-2
◇ Squelch status	10-2
Scan Set mode	10-2
Programmed scan and Fine Programmed scan (VFO mode)	10-3
◇ Programmed scan operation	10-3
◇ Fine Programmed scan operation	10-3
Memory scan and Select Memory scan (Memory mode)	10-4
◇ Memory scan operation	10-4
◇ Select Memory scan operation	10-5
◇ Setting Select Memory channel	10-5
◇ Canceling all Select Memory channel settings	10-5
Δ F scan and Fine Δ F scan (VFO and Memory modes)	10-6
◇ Δ F scan operation	10-6
◇ Fine Δ F scan operation	10-6
Tone scan operation	10-7

Scan types

The IC-7300 has several scan types as listed below.

Scan types	Operation
Programmed scan (p.10-3)	Repeatedly scans between 2 Scan Edge frequencies (Scan Edge memory channels P1 and P2). The scan starts from the lower edge frequency.
Memory scan (p.10-4)	Repeatedly scans all entered Memory channels.
Select Memory scan (p.10-4)	Repeatedly scans all or one of 3 select Memory channels.
ΔF scan (p.10-6)	Repeatedly scans within the ΔF span area. The scan starts from the center frequency.

Preparation

◇ Squelch status

Scans work with the squelch status.

Be sure to adjust the squelch level according to your operating conditions.

- ① When **[AF⇄RF/SQL]** operates as only an RF gain control, you cannot adjust the squelch level.
- ① Normally, set **[AF⇄RF/SQL]** to the point where noise disappears, and the TX/RX indicator goes off.

When the scan starts with the squelch open:

• For a Programmed scan

When the tuning step is 1 kHz or less, the scan continues until it is manually stopped—it does not pause* even if signals are detected.

*The scan pauses when the squelch is closed and then opened. The scan resumes after 10 seconds has passed when the Scan Resume function is ON. It is cancelled when the function is OFF.

When the tuning step is 5 kHz or more, the scan pauses on each step when the Scan Resume function is ON. It does not pause when the function is OFF.

• For a memory scan

The scan pauses on each channel when the Scan Resume function is ON. The scan does not pause when the function is OFF.

When the scan starts with the squelch closed:

The scan stops when a signal is detected.

- When the Scan Resume function is ON, the scan pauses for 10 seconds after detecting a signal, then resumes 2 seconds after the signal disappears.

Scan Set mode

You can set the Scan speed and the Scan Resume function in the Scan Set mode.

1. Open the SCAN screen.

[MENU] » **[SCAN]**

2. Touch **[SET]**.

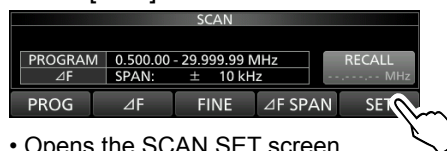

• Opens the SCAN SET screen.

3. Select the desired item.

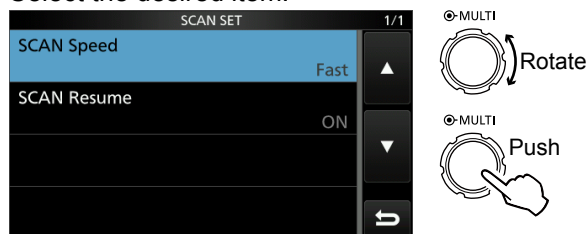

SCAN SET screen

4. Select the desired option.

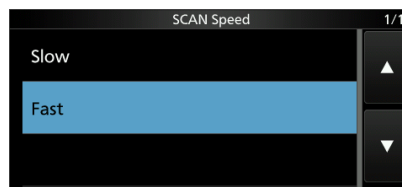

① See below for details of the setting items and their options.

5. To close the SCAN screen, push **[EXIT]** several times.

SCAN Speed (Default: Fast)

Set the desired scan speed to slow or fast.

- Slow: Scan speed is slow.
- Fast: Scan speed is fast.

SCAN Resume (Default: ON)

Set the scan resume function to ON or OFF.

- OFF: When a signal is detected, cancels the scan.
- ON: When a signal is detected, scan pauses for 10 seconds, then resumes. Two seconds after the signal disappears, the scan resumes.

TIP: How to reset to the default setting

Touching the item or its option for 1 second displays the Quick menu, and then touch "Default" to reset to the default setting.

Programmed scan and Fine Programmed scan (VFO mode)

Programmed scan and Fine Programmed scan

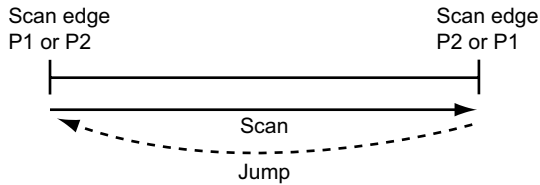

Repeatedly scans between two Scan Edge frequencies. The edge frequencies are preset in P1 and P2 as the default.

P1: 0.500000 MHz P2: 29.999999 MHz

- ① To change the P1 and P2 Scan Edge Memory channels, see “Entering memory channel contents” (p.9-3) for details.
- ① If the same frequencies are entered into P1 and P2, the Programmed scan does not start.
- ① In the Fine Programmed scan, the scan speed decreases when the squelch opens, but the transceiver keeps scanning. The scan tuning step changes to 10 Hz when the squelch opens.

◇ Programmed scan operation

1. Push **[V/M]** to select the VFO mode.
2. Select the operating mode in the MODE screen.
 - ① You can change the operating mode while scanning.
3. Select the desired tuning step in the TS screen.
 - ① You can change the tuning step while scanning.
4. Open the SCAN screen.

[MENU] » **[SCAN]**

5. Touch **[PROG]** to start the Programmed scan.

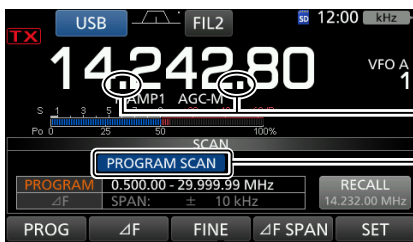
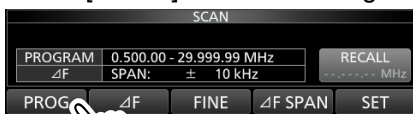

While programmed scanning

① “PROGRAM SCAN” and the decimal points blink while scanning.

6. Touch **[PROG]** to cancel the scan.

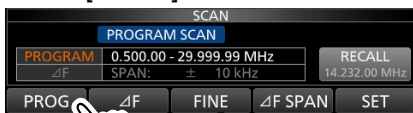

7. To close the SCAN screen, push **[EXIT]**.

◇ Fine Programmed scan operation

1. Start the Programmed scan.
 - ① See steps 1 ~ 5 in “Programmed scan operation” to the left for details.
2. While Programmed scanning, touch **[FINE]** to switch to the File Programmed scan.

While Programmed scanning



Blinks



While Fine Programmed scanning



Blinks

① While Fine Programmed scanning, “FINE PROGRAM SCAN” blinks instead of “PROGRAM SCAN.”

① Each time you touch **[FINE]**, the Programmed scan and the Fine Programmed scan are switched.

3. Touch **[PROG]** to cancel the scan.

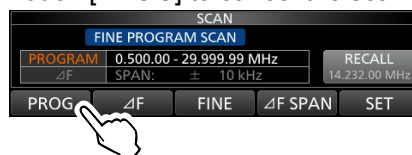

4. To close the SCAN screen, push **[EXIT]**.

Memory scan and Select Memory scan (Memory mode)

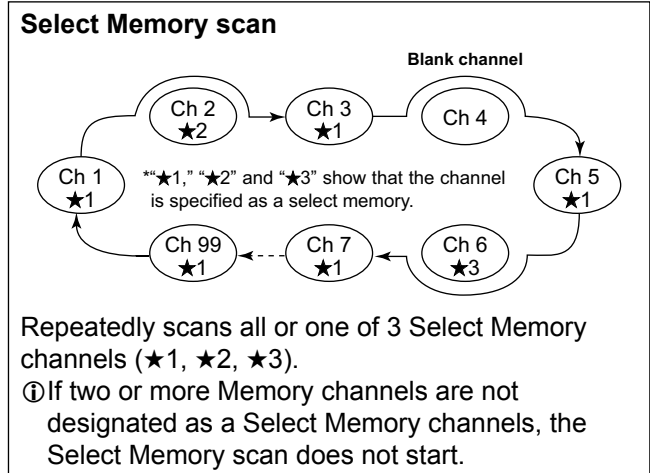
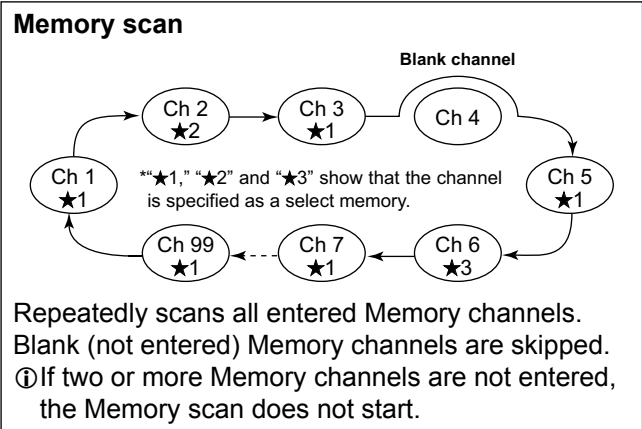

◇ Memory scan operation

1. Push **[V/M]** to select the Memory mode.
2. Open the SCAN screen.
[MENU] » **[SCAN]**
3. Touch **[MEMO]** to start the Memory scan.

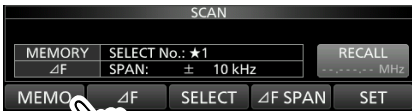

[SEL No.] is displayed instead of [ΔF SPAN].

While Memory scanning

- ① "MEMO SCAN" and decimal points blink while scanning.
 - ① [SEL No.] is displayed instead of [ΔF] while scanning.
4. Touch **[MEMO]** to cancel the scan.

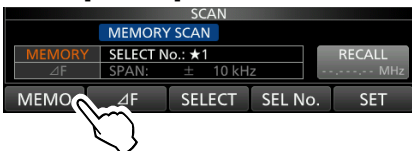

5. To close the SCAN screen, push **[EXIT]**.

Memory scan and Select Memory scan (Memory mode)

◇ Select Memory scan operation

- Start the Memory scan.
 - ① See steps 1 ~ 3 in “Memory scan operation” (p.10-4) for details.
- While scanning, touch [SEL No.] to select the Select scan number.
 - ① Each time you touch [SEL No.], “★1,” “★2,” “★3,” and “★1,2,3” are alternately displayed.
 - ★1: Channels specified as ★1 are scanned.
 - ★2: Channels specified as ★2 are scanned.
 - ★3: Channels specified as ★3 are scanned.
 - ★1,2,3: Channels specified as ★1, ★2, or ★3 are scanned.
- While scanning, touch [SELECT] to switch to the Select Memory scan.

While Memory scanning



While Select Memory scanning

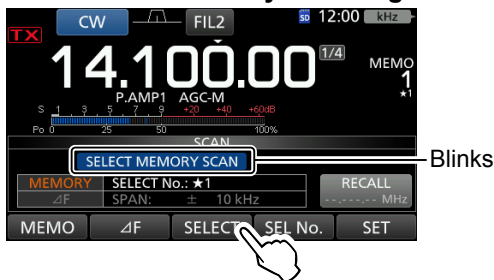

① While Select Memory scanning, “SELECT MEMORY SCAN” blinks instead of “MEMORY SCAN.”

① Each time you touch [SELECT], the Memory scan and the Select Memory scan are switched.

- Touch [MEMO] to cancel the scan.

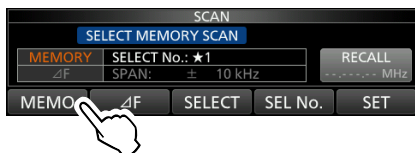

- To close the SCAN screen, push **EXIT**.

◇ Setting Select Memory channel

- Open the SCAN screen.
 - ① See steps 1 ~ 2 in “Memory scan operation” (p.10-4) for details.
- Push **▲** or **▼** to select the desired Memory channel to be set as the Select Memory channel.
- Touch [SELECT] to set the Select scan number.
 - ① Each time you touch [SELECT], “★1,” “★2,” “★3,” and “(no icon)” are alternately displayed.
- To close the SCAN screen, push **EXIT**.



Displayed

◇ Canceling all Select Memory channel settings

- Open the SCAN screen.
 - ① See steps 1 ~ 2 in “Memory scan operation” (p.10-4) for details.
- Touch [SELECT] for 1 second.



• Opens the SELECT ALL CLEAR screen.

- Touch the desired option to clear all Select memory channel settings.

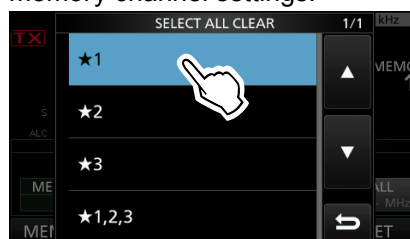

- Touch [YES] to cancel the Select setting.

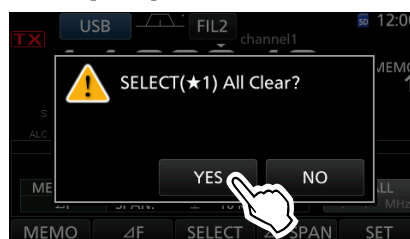

- To close the SCAN screen, push **EXIT**.

ΔF scan and Fine ΔF scan (VFO and Memory modes)

ΔF scan and Fine ΔF scan

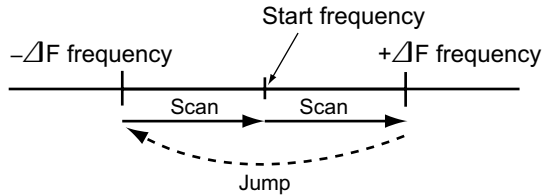

Repeatedly scans within the ΔF span area. The scan starts from the center frequency.

① In fine scan (programmed or ΔF), the scan speed decreases when the squelch opens, but the transceiver keeps scanning. The scan tuning step changes to 10 Hz when the squelch opens.

◇ ΔF scan operation

1. Push **[V/M]** to select the VFO or Memory mode.
2. Open the SCAN screen.
[MENU] » **[SCAN]**
3. Touch **[F SPAN]** several times until the desired span is selected.
 - Options: ±5 kHz, ±10 kHz, ±20 kHz, ±50 kHz, ±100 kHz, ±500 kHz, or ±1 MHz

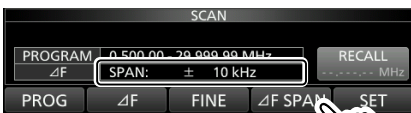

4. Set the center frequency.
 - In the VFO mode: Rotate **(MAIN DIAL)**.
 - In the Memory mode: Push **[▲]** or **[▼]** to select the desired Memory channel.
5. Touch **[ΔF]** to start the ΔF scan.



While ΔF scanning

① "ΔF SCAN" and decimal points blink while scanning.

6. Touch **[ΔF]** to cancel the scan.

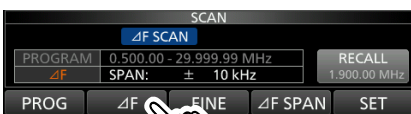

7. To close the SCAN screen, push **[EXIT]**.

◇ Fine ΔF scan operation

1. Start the ΔF scan.
 - ① See steps 1 ~ 5 in "ΔF scan operation" to the left for details.
2. While ΔF scanning, touch **[FINE]** to switch to the Fine ΔF scan.

While ΔF scanning



While Fine ΔF scanning



① While Fine ΔF scanning, "FINE ΔFSCAN" blinks instead of "ΔF SCAN."

① Each time you touch **[FINE]**, the ΔF scan and the Fine ΔF scan are switched.

3. Touch **[ΔF]** to cancel the scan.

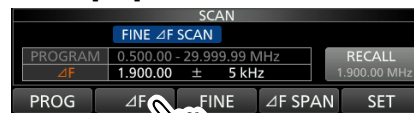

4. To close the SCAN screen, push **[EXIT]**.

Tone scan operation

By monitoring a signal on an HF/6 m repeater input frequency, the transceiver can determine the tone frequency required to access the repeater.

1. While receiving a signal in the FM mode, push **FUNCTION** to open the FUNCTION screen.
2. Touch [TONE] for 1 second.



- Opens the TONE FREQUENCY screen.

3. Touch [REPEATER TONE] or [T-SQL TONE].

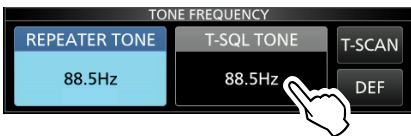

- Checks the repeater tone frequency or tone squelch frequency.

4. Touch [T-SCAN] to start the Tone scan.

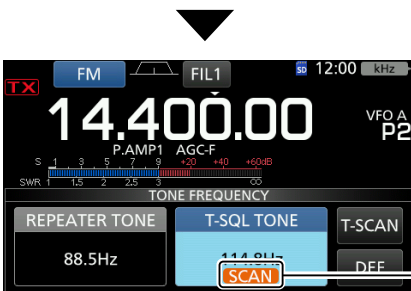
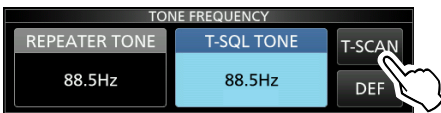

While Tone scanning

6. Touch [T-SCAN] to cancel the scan.

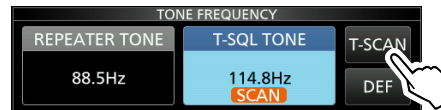

7. To close the TONE FREQUENCY screen, push **EXIT**.

Information

- The selected tone frequencies are scanned, and “SCAN” blinks under the frequency readout.
 - The audio is muted.
 - The scan speed is slow when the squelch is open. And the speed is fast when the squelch is closed.
5. When the tone frequency is detected, the tone scan pauses.
 - The tone frequency is temporarily set in the Tone memory.

About the internal antenna tuner	11-2
Internal antenna tuner operation	11-2
◇ Manual tuning	11-2
◇ PTT Tuner start.....	11-2
About an external antenna tuner	11-3
◇ Using the AH-730 or AH-740	11-3
◇ Using the IC-PW2's antenna tuner	11-3
◇ Using an external antenna tuner.....	11-3
Emergency mode (Tuner).....	11-4

About the internal antenna tuner

The internal automatic antenna tuner automatically matches the transceiver to the antenna within the range of 16.7 ~ 150 Ω (SWR of less than 3:1). When the tuner has matched an antenna over some period of operating time, latching relays of up to 100 combinations have been memorized as preset points. If the frequency is tuned over ± 1.5% of the current memorized frequency point, the tuner uses the relay combinations of the next memorized point (if it is within ± 1.5% of the new frequency). If there are no memorized points with the range, the tuner switches to bypass.

- When you install a new antenna, or you want to change the antenna settings, you can clear the all of the internal antenna tuner preset points with the “<<Preset Memory Clear>>” item on the TUNER set screen. (p. 12-5)

MENU » SET > Function > Tuner > <<Preset Memory Clear>>

- You can select whether or not to save the internal antenna tuner’s status after pushing **TUNER** on each band in the “[TUNER] Switch” item on the TUNER set screen. (p. 12-5)

MENU » SET > Function > Tuner > [TUNER] Switch

NOTE: When the transceiver receives a strong physical shock, some of the internal latching relays may unlatch. In that case, push **TUNER** to turn OFF the tuner, then turn ON again to reset all the latching relays.

Internal antenna tuner operation

1. Push **TUNER** to turn ON the internal antenna tuner.
 - “TUNE” is displayed when the tuner is ON.
2. Tune the antenna.
 - ① To tune the antenna, see “Manual tuning” or “PTT Tuner start” below.

◇ Manual tuning

You can manually tune the antenna before transmitting for the first time.

1. Hold down **TUNER** for 1 second to start manual tuning.
 - The tuner reduces the SWR to less than 1.5:1 after 2~3 seconds of tuning.
 - ① While tuning, “TUNE” blinks red.
2. After tuning, “TUNE” is displayed.
 - ① If the tuner cannot tune, “TUNE” disappears and the tuning circuit is automatically bypassed.

◇ PTT Tuner start

The tuner is always activated when PTT is pushed after the frequency is changed (more than 1% from last-tuned frequency). This function tunes the antenna for the first transmission on a new frequency.

- ① This function can be turned ON in the “PTT Start” item of the TUNER set screen. (p. 12-5)

MENU » SET > Function > Tuner > PTT Start

NOTE: If the SWR is higher than about 1.5:1, hold down **TUNER** for 1 second to start manual tuning.

If the tuner cannot tune the antenna

- Repeat manual tuning several times.
- Even if the tuner cannot tune the antenna on the first tuning, it may success at the second tuning.
- Some antennas, especially for the low bands, have a narrow bandwidth. These antennas may not tune at the edge of their bandwidth, therefore, tune such an antenna as follows:
(Example):
Suppose you have an antenna which has an SWR of 1.5:1 at 3.55 MHz and an SWR of 3:1 at 3.8 MHz.
 1. Set 3.55 MHz, and hold down **TUNER** for 1 second to start manual tuning.
 2. Set 3.80 MHz, and hold down **TUNER** for 1 second to start manual tuning.

TIP: Even if the tuner cannot tune the antenna on the first attempt, it may succeed by repeating the tuning several times.

About an external antenna tuner

The optional AH-730 ANTENNA TUNER matches the IC-7300 to a long wire antenna more than 7 m/23 ft long (between 1.8 MHz and 50 MHz).

The optional AH-740 AUTOMATIC TUNING ANTENNA covers 2.5 to 30 MHz range with a supplied whip antenna.

⚠ DANGER HIGH VOLTAGE!

NEVER touch the antenna element while tuning or transmitting. Always install it in a secure place.

NEVER operate the AH-730 or AH-740 without an antenna connected. The tuner and transceiver will be damaged.

◇ Using the AH-730 or AH-740

1. Turn ON the transceiver.
 - ① Each time you push **TUNER**, "TUNE" is displayed or goes out, and the AH-730 or AH-740 is turned ON or OFF (bypassed).
2. Hold down **TUNER** for 1 second to start manual tuning.
 - The tuner reduces the SWR to less than 2:1 after 2~3 seconds of tuning.
 - ① While tuning, "TUNE" blinks red.
 - ① If the tuner cannot reduce the SWR to less than 2:1 after 15 seconds of tuning, "TUNE" goes out.
3. After tuning, "TUNE" is displayed.
 - ① When the long wire antenna cannot be tuned, "TUNE" goes out. In that case, the AH-730 is bypassed and the wire is directly connected.

NOTE:

- When the wire antenna cannot be tuned, confirm wire length and connection. Note that the AH-730 cannot tune a wire that is a $\frac{1}{2}\lambda$ long or on a multiple of that frequency.
- If you change the operating frequency, perform manual tuning again.

◇ Using the IC-PW2's antenna tuner

When you use the IC-PW2's antenna tuner, be sure to turn OFF the internal antenna tuner before connecting the IC-PW2.

- To tune to the selected operating frequency, the IC-PW2's linked manual tuning operation is needed. When holding down **TUNER** on the IC-PW2 for 1 second, the transceiver automatically starts transmitting to perform the linked manual tuning.
- ① During the linked manual tuning, the meter readout of the transceiver can be changed.
- ① To cancel the linked manual tuning, push **TUNER** on the transceiver. When the linked manual tuning is canceled, the indicator on **TUNER** goes out.

See the IC-PW2's instruction manual for details.

◇ Using an external antenna tuner

When you use a non-Icom external antenna tuner, be sure to turn OFF the internal antenna tuner before connecting the external antenna tuner.

Otherwise, the tuning may fail because both antenna tuners (internal and external) will simultaneously start tuning.

See the antenna tuner's instruction manual for details.

NOTE: Be sure not to connect the antenna tuner without an antenna connected. This could damage the transceiver or external antenna tuner.

TIP: If the SWR is not reduced to 2:1 after retuning, see "If the tuner cannot tune the antenna" (p. 11-2) for details.

Emergency mode (Tuner)

The Emergency mode (Tuner) enables you to use the internal antenna tuner in an emergency situation, but limits the maximum output power to 50 W.

In an emergency situation, where the only antenna you have has a high SWR, you can use the antenna tuner even if the SWR is more than 3:1.

1. Open the EMERGENCY screen.

MENU » **SET > Others > Emergency**

2. Touch "Tuner."



3. Touch [OK].

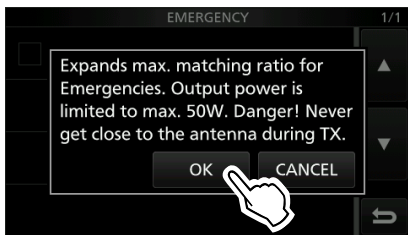

4. Touch "<<Restart to SET>>" to restart the transceiver.

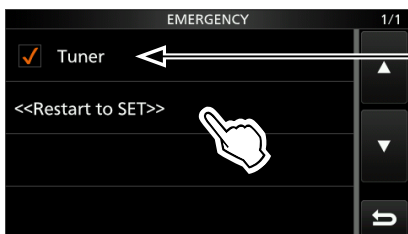

“✓” is inserted.

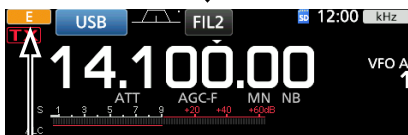

- The transceiver enters the Emergency mode (Tuner).

- E** : Displayed when the internal antenna tuner is OFF.
- E-TUN** : Blinks while tuning.
- E-TUN** : Displayed when the internal antenna tuner is ON.

Section 12 SET MODE

Set mode description.....	12-2
◇ Entering the Set mode.....	12-2
Tone Control/TBW.....	12-3
Function.....	12-4
Connectors.....	12-9
Display.....	12-12
Time Set.....	12-13
SD Card.....	12-13
Others.....	12-14

Set mode description

You can use the Set mode to set infrequently changed values or function settings.

TIP: The Set mode is constructed in a tree structure. You may go to the next tree level, or go back a level, depending on the selected item.

◇ Entering the Set mode

1. Push **MENU**.
 - Opens the MENU screen.

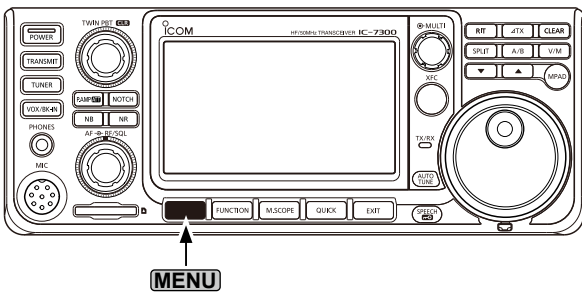

2. Touch [SET].
 - Opens the SET screen.



3. Rotate **MULTI** to select the desired item.
 - ① You can also select the item by touching [U] or [D] in the screen.

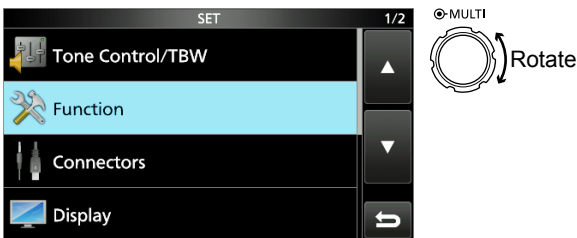

4. Push **MULTI** to go to the next tree level.
 - ① You can also go to the next tree level by directly touching the desired item in the screen.
5. Repeat steps 3 and 4 to open the desired item's setting screen.
 - ① To go back the previous tree level, push **EXIT**.

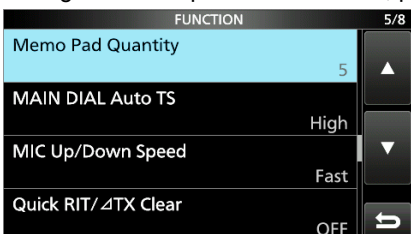

6. Rotate **MULTI** to select the desired option, and then push **MULTI** to set it.

① Information

- You can also select the option by directly touching the option or [▲] or [▼] in the screen.
- When you continuously set other items in the same tree level, repeat step 6.
- When you continuously set other item in the different tree level, push **EXIT** to go back the previous tree level.



TIP: How to reset to the default setting

Touching the item or its option for 1 second displays the Quick menu, and then touch "Default" to reset to the default setting.

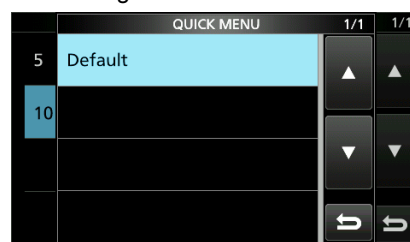

① To close the Quick menu, push **EXIT**.

7. To close the SET screen, push **EXIT** several times.

12 SET MODE

MENU » SET > Tone Control/TBW

Tone Control/TBW

SSB RX HPF/LPF (Default: -----)

Sets the receive audio high-pass filter and low-pass filter cutoff frequencies in 100 Hz steps.

Selectable ranges:

- HPF: 100 ~ 2000 Hz
- LPF: 500 ~ 2400 Hz

① If this item is set, the “SSB RX Bass” and “SSB RX Treble” items are automatically set to “0.”

SSB RX Bass (Default: 0)

SSB RX Treble (Default: 0)

Sets the bass or treble level of the receive audio.

- Range: -5 ~ +5

AM RX HPF/LPF (Default: -----)

Sets the receive audio high-pass filter or low-pass filter cutoff frequencies in 100 Hz steps.

Selectable ranges:

- HPF: 100 ~ 2000 Hz
- LPF: 500 ~ 2400 Hz

① If this item is set, the “AM RX Bass” and “AM RX Treble” items are automatically set to “0.”

AM RX Bass (Default: 0)

AM RX Treble (Default: 0)

Sets the bass or treble level of the receive audio.

- Range: -5 ~ +5

FM RX HPF/LPF (Default: -----)

Sets the receive audio high-pass filter or low-pass filter cutoff frequencies in 100 Hz steps.

Selectable ranges:

- HPF: 100 ~ 2000 Hz
- LPF: 500 ~ 2400 Hz

① If this item is set, the “FM RX Bass” and “FM RX Treble” items are automatically set to “0.”

FM RX Bass (Default: 0)

FM RX Treble (Default: 0)

Sets the bass or treble level of the receive audio.

- Range: -5 ~ +5

CW RX HPF/LPF (Default: -----)

RTTY RX HPF/LPF (Default: -----)

Sets the receive audio high-pass filter or low-pass filter cutoff frequencies in 100 Hz steps.

Selectable ranges:

- HPF: 100 ~ 2000 Hz
- LPF: 500 ~ 2400 Hz

SSB TX Bass (Default: 0)

SSB TX Treble (Default: 0)

Sets the bass or treble level of the receive audio.

- Range: -5 ~ +5

SSB TBW (WIDE) (Default: 100 – 2900)

SSB TBW (MID) (Default: 300 – 2700)

SSB TBW (NAR) (Default: 500 – 2500)

Sets the transmission passband width of wide, mid, or narrow, by changing the lower and higher cutoff frequencies.

- Lower frequency: 100, 200, 300 and 500 Hz
- Higher frequency: 2500, 2700, 2800 and 2900 Hz

SSB-D TBW (Default: 300 – 2700)

Sets the transmission passband width for the SSB-D mode by changing the lower and higher cut-off frequencies.

- Lower frequency: 100, 200, 300 and 500 Hz
- Higher frequency: 2500, 2700, 2800 and 2900 Hz

AM TX Bass (Default: 0)

AM TX Treble (Default: 0)

Sets the bass or treble level of the transmit audio.

- Range: -5 ~ +5

FM TX Bass (Default: 0)

FM TX Treble (Default: 0)

Sets the bass or treble level of the transmit audio.

- Range: -5 ~ +5

12 SET MODE

MENU » SET > Function

Function

Beep Level (Default: 50%)

Sets the beep output level.

- Range: 0 ~ 100%

① If the "Beep (Confirmation)" item is set to "OFF," no beep sounds.

Beep Level Limit (Default: ON)

Selects whether or not to limit the volume up to the specified level.

- OFF: Does not limit the volume level.
- ON: Limits the volume level.

Further rotation of **AF** (inner) does not increase the level.

Beep (Confirmation) (Default: ON)

Turns the Confirmation beep ON or OFF.

- OFF: Does not sound the beep.
- ON: Sounds the beep when a key is pushed.
- If the "Beep Level" item is set to "0%," no beep sounds.

Band Edge Beep (Default: ON (Default))

Turns the Band Edge beep ON or OFF.

- OFF: Does not sound the Band Edge beep.
- ON(Default): The Band Edge beep sounds on the band edge.
- ON(User): The beep, which is selected in the User Band Edge screen, sounds. (p. 3-7)
- ON(User) & TX Limit: The beep, which is selected in the User Band Edge screen, sounds. Transmit is limited to the range between the upper and lower band edges. (p. 3-7)

① Information

- If the "Beep Level" item is set to "0%," no beep sounds.
- When you tune into an amateur band's frequency range, the Band Edge high beep sounds.
- When you tune out of an amateur band's frequency range, the Band Edge low beep sounds.

RF/SQL Control (Default: RF+SQL)

Set the **AF** (outer) control operation.

- Auto: While in the AM or FM mode, operates as only a squelch control. While in the SSB, CW or RTTY mode, operates as only an RF gain control.
- SQL: Operates as only a squelch control. ① RF gain is fixed at maximum sensitivity.
- RF+SQL: Operates as an RF gain control, and a noise squelch* or S-meter squelch. *Only in the FM mode.

When using as an RF gain/squelch control

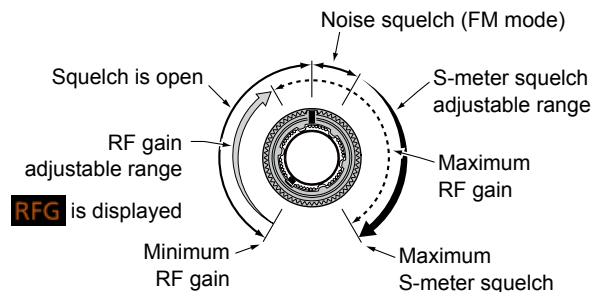

When using as an RF gain control (Squelch is fixed open: SSB, CW, RTTY only)

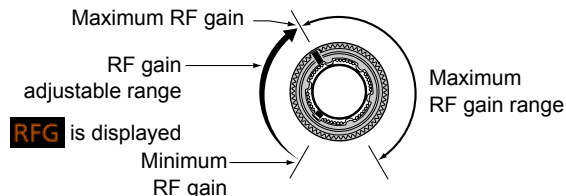

When using as a squelch control (RF gain is fixed at maximum.)

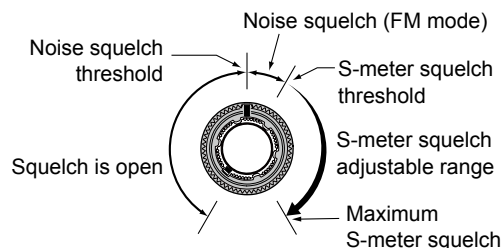

MF Band ATT (Default: ON)

Turns the MF Band Attenuator function ON or OFF.

This function adds approximately 16 dB of attenuation to prevent a desired signal from becoming distorted when very strong MF band signals are received. This function is usable when the frequency is set to between 0.03000 and 1.59999 MHz, for only receiving.

- ① When you receive a weak signal on the MF band, select "OFF."
- ① The 16 dB of the MF band attenuation is added to any other attenuation value that you have set.

12 SET MODE

Function	
TX Delay HF (Default: OFF)	PTT Start (Default: OFF)
TX Delay 50M (Default: OFF)	Turns the PTT Start Tuning function ON or OFF. <ul style="list-style-type: none">• OFF: Starts to tune only when TUNER is ON.• ON: When TUNER is ON and the operating frequency is shifted more than 1%, starts to tune when you push PTT.
TX Delay 70M* (Default: OFF)	<<Preset Memory Clear>>
Sets the TX delay time on the HF, 50 or 70 MHz band. <ul style="list-style-type: none">• Options: OFF, 10ms, 15ms, 20ms, 25ms, or 30ms① If an external equipment's rise time is slower than that of the IC-7300, a reflected wave is produced and it may damage the IC-7300. To prevent this, set the appropriate delay time so that no reflected wave is produced.① Select "OFF" for no rise speed.*Depending on the transceiver's version, this item may not be displayed.	Clears the all of the internal antenna tuner preset points.
Time-Out Timer (CI-V) (Default: OFF)	RTTY Mark Frequency (Default: 2125)
Sets the Time-out Timer for CI-V operation. This setting is valid only transmitting initiated by a CI-V command or pushing TRANSMIT . <ul style="list-style-type: none">• Options: OFF, 3, 5, 10, 20 or 30 minutes① Select "OFF" for no time limit.	Selects the RTTY mark frequency. <ul style="list-style-type: none">• Options: 1275, 1615, or 2125 (Hz)① When the internal RTTY decoder is used, 2125 Hz is automatically selected.
Quick SPLIT (Default: ON)	RTTY Shift Width (Default: 170)
Turns the Quick Split function ON or OFF. <ul style="list-style-type: none">• OFF: Turns OFF the function.• ON: Turns ON the function.	Selects the RTTY shift width. <ul style="list-style-type: none">• Options: 170, 200, or 425 (Hz)① When the internal RTTY decoder is used, 170 Hz is automatically selected.
FM SPLIT Offset (HF) (Default: -0.100 MHz)	RTTY Keying Polarity (Default: Normal)
FM SPLIT Offset (50M) (Default: -0.500 MHz)	Selects the RTTY keying polarity. <ul style="list-style-type: none">• Normal: Key open/close = Mark/Space• Reverse: Key open/close = Space/Mark
Sets the frequency offset for the Split function in the FM mode on the HF or 50 MHz band. <ul style="list-style-type: none">• Range: -9.999 ~ +9.999 MHz	SPEECH Language (Default: English)
SPLIT LOCK (Default: OFF)	Selects the speech language. <ul style="list-style-type: none">• English: Speech in English.• Japanese: Speech in Japanese.
Turns the Split Lock function ON or OFF. <ul style="list-style-type: none">• OFF: Turns OFF the function.• ON: Turns ON the function. You can use MAIN DIAL to adjust the transmit frequency while holding down XFC , even while the Dial Lock function is ON.	SPEECH Speed (Default: Fast)
[TUNER] Switch (Default: Auto)	Selects the speech speed. <ul style="list-style-type: none">• Slow: Speech speed is slow.• Fast: Speech speed is fast.
Selects whether or not to save the internal antenna tuner's status after pushing TUNER on each band. <ul style="list-style-type: none">• Manual: The internal antenna tuner's status is saved on all bands.• Auto: The internal antenna tuner's status is saved on each band.	S-Level SPEECH (Default: ON)
	Turns the S-meter level announcement ON or OFF. <ul style="list-style-type: none">• OFF: The S-meter level is not announced.• ON: The S-meter level and frequency are announced.
	MODE SPEECH (Default: OFF)
	Turns the operating mode announcement ON or OFF. <ul style="list-style-type: none">• OFF: The operating mode is not announced.• ON: The operating mode is announced when the mode is changed.

12 SET MODE

Function





SPEECH Level (Default: 50%)

Sets the Voice Synthesizer audio output level.

- Range: 0 ~ 100%

[SPEECH/LOCK] Switch (Default: SPEECH/LOCK)

Selects  action.

- SPEECH/LOCK: Pushing  turns ON the Voice Synthesizer function.
Holding down  turns the Lock function ON or OFF.
- LOCK/SPEECH: Pushing  turns the Lock function ON or OFF.
Holding down  turns ON the Voice Synthesizer function.

Lock Function (Default: MAIN DIAL)

This function electronically locks **MAIN DIAL** or the panel display* to prevent setting changes by accidental operation.

*Keys and dials are also locked except for **AF**, **RF/SQL**, **AF**, **RF/SQL**, **POWER**, and .

- MAIN DIAL: **MAIN DIAL** is disabled.
① **MAIN DIAL** functions only when selecting an item in the Set mode or Quick menu.
- PANEL: The panel operation is disabled.

Memo Pad Quantity (Default: 5)

Sets the number of memo pad channels.

- 5: 5 channels.
- 10: 10 channels.

MAIN DIAL Auto TS (Default: High)

Sets the Auto Tuning Step function for **MAIN DIAL**.

When rapidly rotating **MAIN DIAL**, the tuning step is automatically changed according to the rotation speed.

- OFF: Auto tuning step is turned OFF.
- LOW: Approximately 2 times faster.
- HIGH: Approximately 5 times faster when the tuning step is set to 1 kHz or smaller steps.
Approximately 2 times faster when the tuning step is set to 5 kHz or larger steps.

MIC Up/Down Speed (Default: Fast)

Sets the response speed of [UP]/[DN] on the supplied microphone while holding down.

- Slow: Slow speed (25 tuning steps/second).
- Fast: Fast speed (50 tuning steps/second).

Quick RIT/ Δ TX Clear (Default: OFF)

Selects the operation of **CLEAR** for the RIT and Δ TX functions.

- OFF: Clears when **CLEAR** is held down for 1 second.
- ON: Clears when **CLEAR** is pushed.

[NOTCH] Switch (SSB) (Default: Auto/Manual)

[NOTCH] Switch (AM) (Default: Auto/Manual)

Selects the notch function used in the SSB or AM mode.

- Auto: Only the Auto notch filter.
- Manual: Only the Manual notch filter.
- Auto/Manual: Both the Auto and Manual notch filters.

SSB/CW Synchronous Tuning (Default: OFF)

Turns the Displayed Frequency Shift function ON or OFF.

This function automatically shifts the frequency to match the CW pitch when the operating mode is toggled between SSB and CW.

- OFF: Stays on the frequency even when the operating mode is toggled between SSB and CW.
- ON: Shifts the frequency when the operating mode is toggled between SSB and CW, to keep receiving the signal.

CW Normal Side (Default: LSB)

Selects the carrier point in the CW normal mode.



- LSB: The LSB side.
- USB: The USB side.

Front Key Customize [VOX/BK-IN] (Default: VOX/BK-IN)

Front Key Customize [AUTOTUNE] (Default: AUTOTUNE)

Front Key Customize [Δ] (Default: M-CH UP)

Front Key Customize [∇] (Default: M-CH DOWN)

The function assignments for the **VOX/BK-IN**, **AUTO TUNE**, , and  keys on the front panel can be changed.
① See page (p. 12-7) about the functions.

MIC Key Customize [UP] (Default: UP (VFO: kHz))

MIC Key Customize [DN] (Default: DOWN (VFO: kHz))

The function assignments for the [UP] and [DN] keys on the microphone can be changed.
① See page (p. 12-8) about the functions.

12 SET MODE

Function

The assignable key functions for Front Key

[VOX/BK-IN]

Function	Description
VOX/BK-IN	Push to turn the VOX function in the Voice operation modes and the Break-in function in the CW mode ON or OFF. Hold down for 1 second to open its function menu.
PRESET	Push to open the PRESET screen.
Voice/Keyer/ RTTY Memory 1	In the SSB, AM, or FM mode <ul style="list-style-type: none"> • Push to transmit the voice audio recorded on the SD card once. • Hold down for 1 second to repeatedly transmit the voice audio. ① If the voice audio is not saved in the Voice TX memory (T1 ~ T4), this function is disabled.
Voice/Keyer/ RTTY Memory 2	In the CW mode <ul style="list-style-type: none"> • Push to transmit the Keyer memory content once. • Hold down for 1 second to repeatedly transmit the memory content. ① If the Keyer memory content (M1 ~ M4) is not entered, this function is disabled.
Voice/Keyer/ RTTY Memory 3	In the RTTY mode <ul style="list-style-type: none"> • Push to transmit the RTTY memory content once. ① If the RTTY memory content (RT1 ~ RT4) is not entered, this function is disabled.
Voice/Keyer/ RTTY Memory 4	In the RTTY mode <ul style="list-style-type: none"> • Push to transmit the RTTY memory content once. ① If the RTTY memory content (RT1 ~ RT4) is not entered, this function is disabled.

[AUTOTUNE]

Function	Description
AUTOTUNE	In the CW mode Push to automatically tune the operating frequency to a close-by CW signal.
PRESET	Push to open the PRESET screen.
Voice/Keyer/ RTTY Memory 1	In the SSB, AM, or FM mode <ul style="list-style-type: none"> • Push to transmit the voice audio recorded on the SD card once. • Hold down for 1 second to repeatedly transmit the voice audio. ① If the voice audio is not saved in the Voice TX memory (T1 ~ T4), this function is disabled.
Voice/Keyer/ RTTY Memory 2	In the CW mode <ul style="list-style-type: none"> • Push to transmit the Keyer memory content once. • Hold down for 1 second to repeatedly transmit the memory content. ① If the Keyer memory content (M1 ~ M4) is not entered, this function is disabled.
Voice/Keyer/ RTTY Memory 3	In the RTTY mode <ul style="list-style-type: none"> • Push to transmit the RTTY memory content once. ① If the RTTY memory content (RT1 ~ RT4) is not entered, this function is disabled.
Voice/Keyer/ RTTY Memory 4	In the RTTY mode <ul style="list-style-type: none"> • Push to transmit the RTTY memory content once. ① If the RTTY memory content (RT1 ~ RT4) is not entered, this function is disabled.

[△]/[▽]

Function	Description
M-CH UP	Push to scroll Memory CH up.
M-CH DOWN	Push to scroll Memory CH down.
PRESET	Push to open the PRESET screen.
Voice/Keyer/ RTTY Memory 1	In the SSB, AM, or FM mode <ul style="list-style-type: none"> • Push to transmit the voice audio recorded on the SD card once. • Hold down for 1 second to repeatedly transmit the voice audio. ① If the voice audio is not saved in the Voice TX memory (T1 ~ T4), this function is disabled.
Voice/Keyer/ RTTY Memory 2	In the CW mode <ul style="list-style-type: none"> • Push to transmit the Keyer memory content once. • Hold down for 1 second to repeatedly transmit the memory content. ① If the Keyer memory content (M1 ~ M4) is not entered, this function is disabled.
Voice/Keyer/ RTTY Memory 3	In the RTTY mode <ul style="list-style-type: none"> • Push to transmit the RTTY memory content once. ① If the RTTY memory content (RT1 ~ RT4) is not entered, this function is disabled.
Voice/Keyer/ RTTY Memory 4	In the RTTY mode <ul style="list-style-type: none"> • Push to transmit the RTTY memory content once. ① If the RTTY memory content (RT1 ~ RT4) is not entered, this function is disabled.

12 SET MODE

Function

The assignable key functions for the MIC Key

Function	Description
---	No function
UP	Push to increase the frequency (in 50 Hz steps*), or Memory channel. * When the Tuning Step function is ON, increases the frequency in the selected Tuning Step.
DOWN	Push to decrease the frequency (in 50 Hz steps*), or Memory channel. * When the Tuning Step function is ON, increases the frequency in the selected Tuning Step.
UP (VFO: kHz)	Push to increase the frequency (in 1 kHz steps*), or Memory channel. * When the Tuning Step function is ON, increases the frequency in the selected Tuning Step.
DOWN (VFO: kHz)	Push to decrease the frequency (in 1 kHz steps*), or Memory channel. * When the Tuning Step function is ON, increases the frequency in the selected Tuning Step.
XFC	While holding down the key, the transceiver monitors signals.
VFO/MEMO	<ul style="list-style-type: none"> • Push to select the VFO mode and the Memory mode. • Hold down for 1 second to copy a Memory channel contents to the VFO.
BAND UP	In the VFO mode <ul style="list-style-type: none"> • Push to increase an operating band. • Hold down for 1 second to recall the Band Stacking Register contents.
BAND DOWN	In the VFO mode <ul style="list-style-type: none"> • Push to decrease an operating band. • Hold down for 1 second to recall the Band Stacking Register contents.
SPEECH	Push to announce the S-meter level, frequency, or operating mode. ① In the VFO or Memory mode, the frequency and the operating mode are announced. ① S-meter level is announced only when the S-level SPEECH function is ON.
MODE	<ul style="list-style-type: none"> • Push to select the operating mode. • Hold down to toggle USB and LSB, CW and CW-R, or RTTY and RTTY-R.

Function	Description
Voice/Keyer/RTTY Memory 1	In the SSB, AM, or FM mode <ul style="list-style-type: none"> • Push to transmit the voice audio recorded on the SD card once. • Hold down for 1 second to repeatedly transmit the voice audio. ① If the voice audio is not saved in the Voice TX memory (T1 ~ T4), this function is disabled.
Voice/Keyer/RTTY Memory 2	In the CW mode <ul style="list-style-type: none"> • Push to transmit the Keyer memory content once. • Hold down for 1 second to repeatedly transmit the memory content. ① If the Keyer memory content (M1 ~ M4) is not entered, this function is disabled.
Voice/Keyer/RTTY Memory 3	In the RTTY mode Push to transmit the RTTY memory content once. ① If the RTTY memory content (RT1 ~ RT4) is not entered, this function is disabled.
Voice/Keyer/RTTY Memory 4	Push to transmit the RTTY memory content once. ① If the RTTY memory content (RT1 ~ RT4) is not entered, this function is disabled.
TS	<ul style="list-style-type: none"> • Push to turn the Tuning Step function ON or OFF. • Hold down for 1 second to open the TS screen.
MPAD	<ul style="list-style-type: none"> • Push to sequentially call up the contents in the Memo Pads. • Hold down for 1 second to save the displayed contents into the Memo Pad.
SPLIT	<ul style="list-style-type: none"> • Push to turn the Split function ON or OFF. • Hold down 1 second to turn ON the Quick Split function.
A/B	<ul style="list-style-type: none"> • Push to select the VFO A or VFO B. • Hold down for 1 second to set the displayed VFO's frequency to the VFO that is not displayed.
TUNER	<ul style="list-style-type: none"> • Push to turn the antenna tuner ON or OFF. • While "TUNE" is displayed, hold down for 1 second to start manual tuning.

12 SET MODE

Function

Screen Capture [POWER] SW (Default: OFF)

Assigns the Screen Capture function to [POWER].

- OFF: [POWER] does not act as the Screen Capture key.
- ON: [POWER] acts as the Screen Capture key.

Screen Capture File Type (Default: PNG)

Selects the file format for the Screen Capture function.

- Options: PNG or BMP

TIP: When the “Screen Capture [POWER] SW” item is “ON,” you can capture the screen in the following way:

1. Set a desired screen.
2. Push [POWER] to capture the screen.
 - The captured screen is saved onto the SD card in the selected data format.
 - ① You can display the captured screen on the transceiver’s display. See page 13-5 for details.

Keyboard Type (Default: Full Keyboard)

Sets the keyboard entry type to Ten-key or Full Keyboard.

- Ten key: Ten-key type
- Full Keyboard: Full Keyboard type
 - ① You can enter upper case letters, lower case letters, numbers, some symbols and spaces with this type.

① When the edit screen is displayed, push [QUICK] to display the Quick menu.
You can select the desired keyboard type.

Screen Full Keyboard Layout (Default: English)

Sets the on-screen keyboard to English, German, or French.

Calibration Marker (Default: OFF)

Turns the reference frequency calibration marker ON or OFF.

- OFF: Turns OFF the marker.
- ON: Turns ON the marker.

REF Adjust

Adjusts the internal reference frequency.

- Range: 0.0 ~ 100.0%

NOTE:

- The default setting of “REF Adjust” may differ slightly, depending on the transceiver’s version.
- Before performing a frequency calibration, you have to set “Calibration Marker” to ON.

MENU » SET > Connectors

Connectors

ACC/USB Output Select (Default: AF)

Selects the signal output from [ACC] and [USB].

- AF: AF signal is output.
- IF: A 12 kHz IF signal is output.
 - ① You can listen to the Digital Radio Mondiale (DRM) broadcast with the application software receiver that is installed into your PC.

ACC/USB AF Output Level (Default: 50%)

Sets the AF output level of [ACC] and [USB].

- Range: 0 ~ 100%

ACC/USB AF SQL (Default: OFF (OPEN))

Selects whether or not to output the audio from [ACC] and [USB], according to the squelch level.

The same audio signals are output from [USB] and [ACC].

- OFF(OPEN): The squelch is always opened regardless of the transceiver’s squelch level.
- ON: The squelch opens and closes, according to the transceiver’s squelch level.

ACC/USB AF Beep/Speech... Output (Default: OFF)

Sets the Beep and Speech audio output status of [ACC] and [USB].

- OFF: The beep and speech audio are not output from [ACC] and [USB].
- ON: The beep and speech audio are output from [ACC] and [USB].

① You should set the “ACC/USB AF SQL” item to “AF.”

① The beep level is limited when the “Beep Level Limit” item is “ON.”

ACC/USB IF Output Level (Default: 50%)

Sets the IF output level of [ACC] and [USB].

- Range: 0 ~ 100%

ACC MOD Level (Default: 50%)

Sets the modulation input level of [ACC].

- Range: 0 ~ 100%

USB MOD Level (Default: 50%)

Sets the modulation input level of [USB].

- Range: 0 ~ 100%

12 SET MODE

Connectors

DATA OFF MOD (Default: MIC,ACC)

Selects the connector(s) to input the modulation signal when the data mode is OFF.

- MIC: Uses the signal from [MIC].
- ACC: Uses the signal from [ACC] (pin 11).
- MIC,ACC: Uses the signal from [MIC] and [ACC] (pin 11).
- USB: Uses the signal from [USB].
- MIC,USB: Uses the signal from [MIC] and [USB].

DATA MOD (Default: ACC)

Selects the connector(s) to input the modulation signal when the data mode is ON.

- MIC: Uses the signal from [MIC].
- ACC: Uses the signal from [ACC] (pin 11).
- MIC,ACC: Uses the signal from [MIC] and [ACC] (pin 11).
- USB: Uses the signal from [USB].
- MIC,USB: Uses the signal from [MIC] and [USB].

① Touching the [DATA] key in the MODE screen activates the data mode.

② Automatically sets the modulation input to the connector(s) selected in this item, for all three data modes.

External Keypad VOICE (Default: OFF)

Enables voice memory transmission using an external keypad.

- OFF: Turns OFF the function.
- ON: Pushing one of the external keypad switches transmits the content of voice memory (T1 ~ T4). (SSB/AM/FM mode)
① Hold down the switch for 1 second to repeatedly transmit.

External Keypad KEYER (Default: OFF)

Enables keyer memory transmission using an external keypad.

- OFF: Turns OFF the function.
- ON: Pushing one of the external keypad switches, transmits the content of keyer memory (M1 ~ M4). (CW mode)
① Hold down the switch for 1 second to repeatedly transmit.

External Keypad RTTY (Default: OFF)

Enables RTTY memory transmission using an external keypad.

- OFF: Turns OFF the function.
- ON: Pushing one of the external keypad switches, transmits the entered RTTY memory (RT1 ~ RT4). (When the RTTY decode screen is opened in the RTTY mode)

CI-V Baud Rate (Default: Auto)

Selects the CI-V data transfer rate.

- Options: 4800, 9600, 19200 (bps) or Auto
- ① When "Auto" is selected, the baud rate is automatically set according to the data rate of the connected controller.

CI-V Address (Default: 94h)

Selects the CI-V address.

- Range: 02h ~ 94h ~ DFh
- ① "94h" is the default address of IC-7300.

CI-V Transceive (Default: ON)

Turns the Transceive function ON or OFF.

- OFF: The status is not output.
- ON: The status is output.
When you change a setting on the transceiver, the same change is automatically set on other connected transceivers or receivers, and vice versa.

CI-V USB→REMOTE Transceive Address (Default: 00h)

Sets the address used to remotely control the transceiver or receiver using the optional RS-BA1, through the [USB] port.

The external equipment control signal is output from the [REMOTE] port.

- Range: 00h ~ DFh

TIP: When multiple devices are connected.

The default transceive address is "00h." To control dedicated equipment (example IC-PW2) when several devices are connected, set the same CI-V address.

CI-V Output (for ANT) (Default: OFF)

Enables outputting the antenna controller status (frequency and so on) from the [REMOTE] port.

- OFF: Turns OFF the function.
- ON: Outputs the status.
① Address "01h" is reserved.
The usable addresses are limited to 02h ~ DFh.

CI-V USB Port (Default: Unlink from [REMOTE])

Selects the internal connection type between the [USB] and [REMOTE] CI-V ports.

- Link to [REMOTE]:
The [USB] and [REMOTE] CI-V ports are internally connected.
- Unlink from [REMOTE]:
The [USB] and [REMOTE] CI-V ports are not internally connected.
Each port functions independently.
(duplex communication can be made.)

12 SET MODE

Connectors

CI-V USB Baud Rate (Default: Auto)

Selects the CI-V data transfer rate when remotely controlling the IC-7300 through the [USB] CI-V port.

- Options: 4800, 9600, 19200, 38400, 57600, 115200 (bps), or Auto

① When “Auto” is selected, the baud rate is automatically set according to the data rate of external controller.

① This setting is valid only when the “CI-V USB Port” item is set to “Unlink from [REMOTE].”

CI-V USB Echo Back (Default: OFF)

Turns the Data Echo Back function ON or OFF, when remotely controlling the IC-7300 through the [USB] CI-V port.

- OFF: Turns OFF the function.
- ON: Turns ON the function.

① This setting is valid only when the “CI-V USB Port” item is set to “Unlink from [REMOTE].”

USB Serial Function (Default: CI-V)

Selects the signal output from [USB].

- CI-V: A CI-V command is output.
- RTTY Decode: An RTTY decoded signal is output.

RTTY Decode Baud Rate (Default: 9600)

Selects the data transfer rate (Baud rate) of decoded RTTY signals.

- Options: 4800, 9600, 19200, or 38400 (bps)

USB SEND (Default: OFF)

You can control transmit and receive from the PC through the USB port.

Selects the control port to be used for communication between the IC-7300 and PC, according to the operating condition.

- OFF: Turns OFF the function.
- DTR: Uses the DTR terminal on the CI-V (PC) side.
- RTS: Uses the RTS terminal on the CI-V (PC) side.

① You cannot select the terminal which is already selected in the “USB Keying (CW)” item.

USB Keying (CW) (Default: OFF)

You can control transmit, receive and keying from the PC, through the USB port.

Selects the control port to be used for communication between the IC-7300 and PC, according to the operating condition.

- OFF: Turns OFF the function.
- DTR: Uses the DTR terminal on the CI-V (PC) side.
- RTS: Uses the RTS terminal on the CI-V (PC) side.

① You cannot select the terminal which is already selected in the “USB SEND” item.

USB Keying (RTTY) (Default: OFF)

You can control transmit, receive and RTTY (FSK) from the PC, through the USB port.

Selects the control port to be used for communication between the IC-7300 and PC according to the operating condition.

- OFF: Turns OFF the function.
- DTR: Uses the DTR terminal on the CI-V side.
- RTS: Uses the RTS terminal on the CI-V side.

① You cannot select the terminal which is already selected in the “USB SEND” item.

Inhibit Timer at USB Connection (Default: ON)

Turns the timer for SEND or Keying signal transmission ON or OFF.

When using a PC with an old USB driver installed, and an IC-7300 through a USB cable, turning ON the timer prevents an unintentional sending of the SEND or Keying signal when:

- Connecting a USB cable to the PC and IC-7300.
- A virtual serial port communication is established.
- Starting up the PC while it is connected to the IC-7300.
- Connecting or disconnecting another USB device to or from the PC, while the IC-7300 is connected to the PC.
- OFF: Sends the SEND or Keying signal immediately.
- ON: Pauses for a few seconds before sending the signal.

① If you change this setting to “OFF,” first update the transceiver’s USB driver and make sure the SEND or Keying signal will not be unintentionally sent.

PTT Port Function (Default: PTT Input + SEND Output)

- PTT Input: While transmitting, the transceiver does not output the SEND signal (TX status) from the PTT pin, but does detect the PTT input (PTT operation) on the microphone.

① Use this option if you want to cancel transmitting the recorded audio by pushing [PTT] on the microphone.

- PTT Input + SEND Output: While transmitting using other than the operating microphone, the transceiver does not detect the PTT input (PTT operation) of the microphone, due to the output SEND signal from the PTT pin.

12 SET MODE

MENU » SET > Display

Display

LCD Backlight (Default: 50%)

Sets the LCD backlight brightness.

- Range: 0 (dark) ~ 100% (bright)

Display Type (Default: A)

Sets the display background type to A or B. (p. 13-3)

- A: Display background color is black.
- B: Display background color is blue.

Display Font (Default: Basic)

Selects the font for the frequency readout.

- Options: Basic or Round

Meter Peak Hold (Default: ON)

Turns the Meter peak hold function ON or OFF.

Memory Name (Default: ON)

Turns the Memory name display in the Memory mode ON or OFF.

- OFF: Memory name is not displayed, even if entered.
- ON: The entered Memory name is displayed below the frequency display.

MN-Q Popup (MN OFF→ON) (Default: ON)

Selects whether or not to display the Manual Notch filter width when you select the Manual Notch.

- OFF: The Manual Notch filter width is not displayed.
- ON: The Manual Notch filter width is displayed.

BW Popup (PBT) (Default: ON)

Selects whether or not to display the PBT shift value while rotating **TWIN PBT CLR**.

- OFF: The the PBT shift value is not displayed.
- ON: The the PBT shift value is displayed.

BW Popup (FIL) (Default: ON)

Selects whether or not to display the IF filter width and shift value when you switch the IF filter by touching the filter icon.

- OFF: The IF filter width and shift value are not displayed.
- ON: The IF filter width and shift value are displayed.

Screen Saver (Default: 60min)

Sets the Screen Saver function.

This function activates and automatically turns OFF the screen when no operation is performed for the preset period of time.

- OFF: Turns OFF the function.
- 15min: Activates after 15 minutes with no operation.
- 30min: Activates after 30 minutes with no operation
- 60min: Activates after 60 minutes with no operation

Opening Message (Default: ON)

Selects whether or not to display the opening message at power ON.

- OFF: Opening message is not displayed.
- ON: Opening message is displayed.

My Call

Displays an opening message of up to 10 characters. (Example: your call sign) (p. 13-5)

Power ON Check (Default: ON)

Selects whether or not to display the RF Power level at power ON.

- OFF: The RF Power level is not displayed.
- ON: The RF Power level is displayed.

Display Language (Default: English)

Sets the display language.

- English: Displays in English.
- Japanese: Displays in Japanese.

12 SET MODE

MENU » **SET > Time Set**

Time Set

Date (Default: 2000/01/01)

Sets the date (Year/Month/Day).

(The day of the week is automatically set.)

• Range: Year 2000 ~ 2099, Month/Day 1-1 ~ 12-31

Time (Default: 0:00)

Sets the current time.

(The time is displayed in the 24 hour format.)

NOTE: The backup battery for the internal clock

The IC-7300 has a rechargeable Lithium battery to backup the internal clock. If you connect the transceiver to a power source, the battery is charged and it keeps the correct clock setting. However, if you do not connect the transceiver to a power source for a long period of time, the battery will discharge. In that case, the transceiver resets the internal clock.

If you do not use the transceiver for a long period, we recommend that you connect the transceiver to a power source at least once a month. The charging period is two days whether the transceiver's power is ON or OFF.

UTC Offset (Default: ± 0:00)

Sets the UTC offset time.

• Range: -14:00 to +14:00 (in 5 minute steps)

MENU » **SET > SD Card**

SD Card

Load Setting

Selects the saved data file to load.

① See "Loading the saved data files onto an SD card" (p. 8-6) for details.

Save Setting

Saves the setting data onto an SD card.

① See "Saving the setting data onto an SD card" (p. 8-4) for details.

SD Card

Save Form (Default: Now Ver)

Selects the format to save the settings onto an SD card.

Now Ver: Saves the settings in the current version format.

Old Ver (x.xx - x.xx): Saves the settings in older version format indicated in the parenthesis (x.xx = version).

NOTE:

- If you select "Old Ver (xxx - xxx)," a function that is added when the transceiver's firmware format is updated will not be saved.
- You cannot load a setting file that is saved in the current version format to an earlier firmware version.

SD Card Info

Displays the SD card capacity and the time remaining for voice recording.

① See "Displaying the information" (p. 8-7) for details.

Screen Capture View

Displays the selected screen capture.

① See "Screen Capture function" (p. 13-5) for details.

Firmware Update

Displays the Firmware Update mode.

① See "Updating the firmware" (p. 15-5) for details.

Format

Formats the SD card.

If you use a brand new SD card, be sure to format it.

① See "Formatting an SD card" (p. 8-3) for details.

Unmount

Unmounts the SD card.

Before you remove a card when the transceiver is ON, be sure to electrically unmount it.

Otherwise the data may be corrupted or deleted.

① See "Unmounting an SD card" (p. 8-3) for details.

12 SET MODE

MENU » **SET > Others**

Others

Version

Displays the transceiver firmware's version number.

Touch Screen Calibration

Touch to adjust the touch screen.

① See "Touch screen calibration function" (p. 14-3) for details.

Partial Reset

Resets operating settings to their default values (VFO frequency, VFO settings, menu contents) without clearing the items below:

- Memory channel contents
- MY Call
- Memory Keyer
- RTTY memory
- User Band Edge
- REF Adjust
- Fixed Edges
- PRESET memory content

① See "Resetting" (p. 14-4) for details.

All Reset

Clears all data and returns all settings to their factory defaults.

Memory channel contents, filter setting and so on will all be cleared, so you will need to rewrite your operating settings.

① See "Resetting" (p. 14-4) for details.

Emergency

Sets the Emergency function.

This function enables you to use the internal antenna tuner in an emergency situation, but limits the maximum output power to 50 W.

① See "Emergency mode (Tuner)" (p. 11-4) for details.

Section 13 OTHER FUNCTIONS

Adjusting the main dial friction.....	13-2
Using the SPEECH function.....	13-2
Measuring SWR	13-2
◇ Spot measurement	13-2
◇ Plot measurement.....	13-3
Selecting the display type and font.....	13-3
◇ Selecting the display background	13-3
◇ Selecting the display font.....	13-3
Protection function.....	13-4
REF adjustment.....	13-4
Displaying my call sign	13-5
Screen Capture function.....	13-5
◇ Capturing a screen	13-5
◇ Viewing the captured screen.....	13-5
PRESET menu	13-6
◇ Loading the preset memory	13-6
◇ Editing the memory contents	13-6
Transmitter Lockout function	13-6

Adjusting the main dial friction

You can adjust the friction of **(MAIN DIAL)** to suit your preference.

The friction adjuster is located under **(MAIN DIAL)**. See the illustration below.

Slide the adjuster for a comfortable friction level while continuously and evenly turning the dial in one direction.

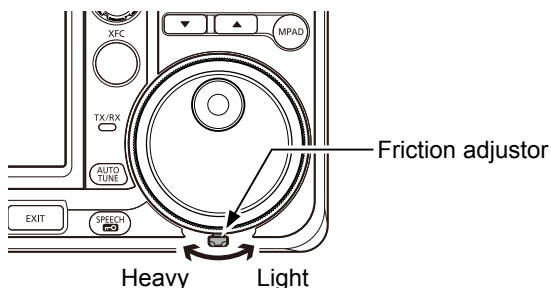

Using the SPEECH function

The transceiver has a built-in Voice synthesizer to announce the operating frequency, mode, as well as the S-meter level in a clear electronically-generated voice, in either English or Japanese.

First, set the following items in the SPEECH screen.

(MENU) » **(SET > Function > SPEECH)**

- SPEECH Language
- SPEECH Speed
- S-Level SPEECH
- MODE SPEECH
- SPEECH Level

- Push **(SPEECH)** to announce the currently selected frequency, mode*, and S-meter* level.
*If set to ON, the Mode and S-meter level are announced.

Measuring SWR

The transceiver has a high-performance SWR meter. This meter displays a stable measurement in real time, even if the transmit output power varies frequently, such as during an SSB mode operation. You can measure the SWR of an antenna itself through the internal antenna tuner. There are 2 ways to measure SWR, one is *spot measurement* and the other is *plot measurement*.

◆ Spot measurement

1. Push **(TUNER)** to turn OFF the antenna tuner.
 - ① Perform this step if the antenna tuner is connected and you want to measure the SWR of the antenna itself.
2. Select the RTTY or RTTY-R mode.
3. Set the desired frequency band and a frequency in the portion of the band that you use the most.
4. If necessary, adjust the RF power to more than 30 W in the Multi-function menu.
 - 70 MHz: 20 W
(70 MHz band transmission may be possible, depending on the transceiver version.)
5. Touch the TX meter several times until the SWR meter is selected. (p. 13-3)

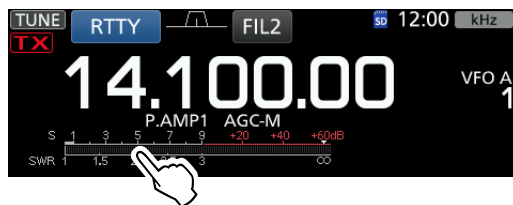

NOTE: Before transmitting, monitor the operating frequency to make sure you will not cause interference to other stations on the same frequency.

6. Push **(TRANSMIT)** or hold down [PTT] on the microphone to transmit.
7. Read the SWR on the meter.
 - ① If the SWR meter indicates 1.5 or less, the antenna is matched.

SWR meter

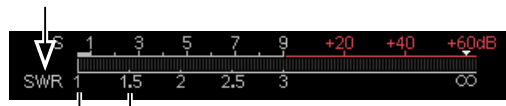

The best match is within this range.
(1.5 or less)

8. Push **(TRANSMIT)** or release [PTT] to stop transmitting.
 - ① If the measured SWR is more than 1.5:1, push [TUNER] to match the antenna with the transceiver.

13 OTHER FUNCTIONS

Measuring SWR (Continue)

◇ Plot measurement

You can measure the SWR over the entire set frequency range.

1. Set the desired frequency band.
2. If necessary, adjust the RF power to approximately 30 W in the Multi-function menu.
 - 70 MHz: 20 W
 - (70 MHz band transmission may be possible, depending on the transceiver version.)

NOTE: Before transmitting, monitor the operating frequency to make sure you will not cause interference to other stations on the same frequency.

3. Open the SWR GRAPH screen.
 - MENU** » **SWR**
4. Set the center frequency for the SWR to be measured. (Example: 14.080.00)
5. If necessary, touch [STEP] several times until the measuring step is selected, or touch [BAR] several times until the number of graph bars is selected.
 - ① You can select between 10, 50, 100, and 500 kHz measuring steps.
 - ① You can select between 3, 5, 7, 9, 11 and 13 graph bars.

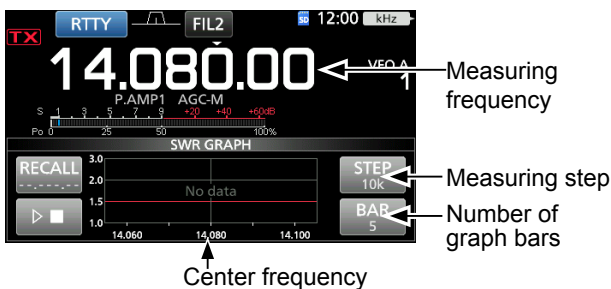

6. Touch **[▶]** to start measuring.
 - The frequency marker “▲” and the measurement frequency are displayed.
7. Push **TRANSMIT** or hold down [PTT] on the microphone to transmit.
 - The bar graph displays the SWR.

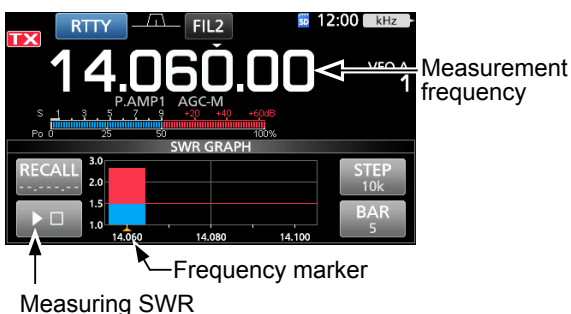

8. Push **TRANSMIT** or release [PTT] to stop transmitting.
9. Repeat steps 7 and 8 to measure the SWR over the entire frequency range.

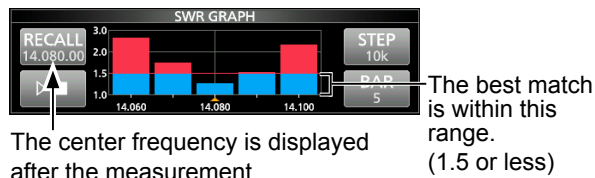

TIP:

- Rotate **MAIN DIAL** to move the frequency marker “▲” to the current transmit frequency.
- “<<” (low) or “>>” (high) is displayed when the transmitted frequency is out of the displayed range.
- Touch [RECALL] for 1 second to move the frequency marker “▲” back to the center frequency.
- Touch the bar graph to delete the measured SWR.



Selecting the display type and font

You can select between 2 display backgrounds and 2 frequency readout fonts.

◇ Selecting the display background

1. Select the “Display Type” screen.
 - MENU** » **SET > Display > Display Type**
2. Set the background A or B by rotating and then pushing **(MULTI)**.
 - A: Black background (default)
 - B: Blue background
3. To close the DISPLAY screen, push **EXIT** several times.

◇ Selecting the display font

1. Select the “Display Font” screen.
 - MENU** » **SET > Display > Display Font**
2. Set the desired display font to “Basic” or “Round” by rotating, and then pushing **(MULTI)**.
 - Basic (Default):
 - Round:
3. To close the DISPLAY screen, push **EXIT** several times.

Protection function

The transceiver has a 2 step protection function to protect the final power amplifiers in case the antenna SWR becomes high.

The function detects the power amplifier temperature and activates when the temperature becomes too high.

Power down transmission

Reduces the transmission output power.

- "LMT" is displayed below **TX** while transmitting.

TX inhibit

Disables the transmitter.

- **TX** is displayed instead of **TX** while the transmitter is disabled.

When the function is activated, wait until the power amplifier cools down by using the transceiver to only receive.

NOTE: Do not turn OFF the transceiver power when the Protection function is activated. If you do, the cooling fan will deactivate and it will take longer to cool down.

- You can check the power amplifier temperature with the TEMP gauge in the Multi-function meter.

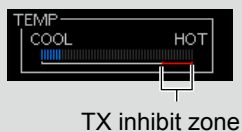

REF adjustment

You can perform a rough frequency calibration by receiving the radio station WWV, WWVH, or other frequency signals.

NOTE:

- The transceiver has been adjusted and tested at the factory before being shipped out. You should not have to re-calibrate.
- Before performing a frequency calibration, you have to set "Calibration Marker" to ON.
- Spurious signal waveforms may be displayed while the Calibration Marker is ON.

① Before performing a frequency calibration, set the following items as described in the table below.

AF → RF/SQL	Decent audibility
AF → RF/SQL	Maximum RF gain
TWIN PBT CLR	Reset by holding down for 1 second.
Operating mode	USB
RIT	OFF (No RIT icon displayed)

1. Set the frequency to the standard frequency station minus 1 kHz.
 - ① If receiving WWV or WWVH (at 15.00000 MHz) as your standard frequency, set the operating frequency to 14.99900 MHz.
2. Set "Calibration Marker" to ON.
 - MENU** » **SET > Function > Calibration Marker**
3. Select the "REF Adjust" item.
 - MENU** » **SET > Function > REF Adjust**
4. Rotate **(MULTI)** to adjust for a zero beat with the received standard signal.
 - ① "Zero beat" means that the exact same frequencies are set to 2 signals, resulting in a single tone being transmitted.
5. Set "Calibration Marker" to OFF.
6. Push **(EXIT)** several times until the SET screen is closed.

Displaying my call sign

You can display your own call sign at power ON.

[Example: Displaying the call sign JA3YUA]

1. Open the MY CALL screen.
MENU » **SET > Display > My Call**
2. Enter your call sign of up to 10 characters.
 ① See “Keyboard entering and editing” (p. 1-9) for details.
3. Touch [ENT] to save the entered call sign.

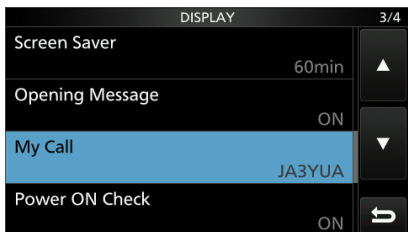
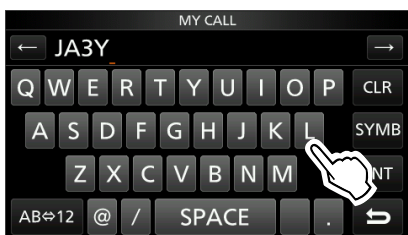

- The MY CALL screen closes and returns to the DISPLAY screen.
- The entered name is displayed.
- The entered call sign is displayed at power ON.

Screen Capture function

You can capture the transceiver display onto an SD card. Most of the screens used in this manual are captured using this function. However, some displays cannot be captured.

◇ Capturing a screen

1. Open the “Screen Capture [POWER] SW” screen.
MENU » **SET > Function > Screen Capture [POWER] SW**
2. Select “ON” by rotating and pushing **(MULTI)**.
3. Select the desired screen to capture.
4. Push **(POWER)** to capture the screen.
 - The captured screen is saved onto the SD card.

◇ Viewing the captured screen

1. Open the SCREEN CAPTURE VIEW screen.
MENU » **SET > SD Card > Screen Capture View**
 - The capture list is displayed.
 - The latest screen capture is at the top of the list.
2. Select the desired screen capture to be displayed by rotating and pushing **(MULTI)**.
 - The selected screen capture is displayed.

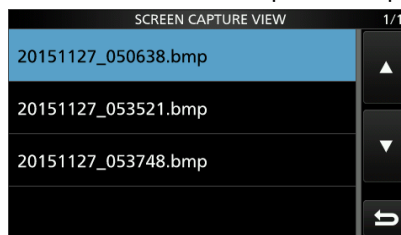

① While a screen capture is displayed, you can scroll through all the screen captures by rotating **(MULTI)**.

Other options in the capture list

1. While the capture list is displayed, push **(QUICK)** to display the QUICK MENU.

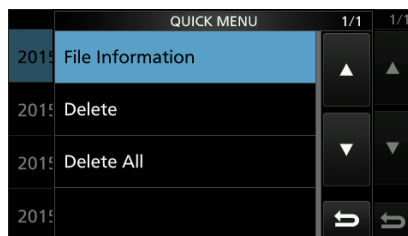

2. Select the desired option.
 - **File Information:** Displays the name, size, and date of the selected screen capture.
 - **Delete:** The confirmation dialog is displayed before deleting the file. Select [YES] to delete or select [NO] to cancel.
 - **Delete All:** The confirmation dialog is displayed before deleting all the files on the list. Select [YES] to delete or select [NO] to cancel.

PRESET menu

You can save the combination of the following settings for the data mode to quickly change the settings, depending on your operating needs.

Preset Name	SSB TBW
Mode	SSB TX Bandwidth
Filter	USB SEND
Filter BW	USB Keying (CW)
Filter Type (HF)	USB Keying (RTTY)
Filter Type (50M -)	Inhibit Timer at USB Connection
ACC/USB Output Select	CI-V Baud Rate
ACC/USB AF Output Level	CI-V Address
ACC/USB AF SQL	CI-V Transceive
ACC/USB IF Output Level	USB Serial Function
USB MOD Level	CI-V USB Port
DATA MOD	CI-V USB Baud Rate
SSB-D TX Bandwidth	CI-V USB Echo Back
DATA OFF MOD	
COMP	

① The transceiver has a total of 5 memories.

◇ Loading the preset memory

1. Push **MENU**.
2. Touch ② at the center bottom of the screen.
3. Touch [PRESET].



4. Touch the preset memory to load.
5. Touch [YES].
 - The selected preset memory is loaded, and “In Use” is displayed on the PRESET screen. If you change the transceiver settings, and they do not match the contents of the preset memory, “In Use” disappears.
 - ① Touching [UNLOAD] returns the transceiver settings to those set before loading the preset memory.

NOTE:

- You cannot load the preset memory content when you select a blank memory channel in the Memory mode.
- You cannot load a preset memory that is displayed as “(BLANK).”

◇ Editing the memory contents

NOTE: You cannot edit the preset memory that is in use. To edit it, first touch [UNLOAD], and then edit the memory.

1. On the PRESET screen, touch a preset memory to edit for 1 second.
 - Opens the QUICK MENU screen.
2. Touch “Edit the Preset Memory.”
 - ① When touching “Save to the Preset Memory,” all of the contents are set to the current settings before editing.
3. Touch the check box to select whether or not to load the item.
4. “✓” is displayed on the left side of the loading item.
5. Touch the item name, and then touch the option to set.
 - ① You can set the preset name of up to 16 characters.
6. Repeat steps 3 and 4 to edit the preset memory.
7. Touch “<<Write>>.”
8. Touch [YES].

TIP: Depending on your software, you may need to change the “CI-V Address” setting. For example, you use a software that is not compatible with the IC-7300. In that case, you may be able to use the software by setting “CI-V Address” to another transceiver’s address.

Transmitter Lockout function

When 2 Icom excitors that support the Transmitter Lockout function, including the IC-7300, are connected to the IC-PW2 to Single Operator Two Radios (SO2R) operation, the function prevents the simultaneous transmission from the excitors.

① When the TX inhibit command (16 66) is sent to the exciter connected to the IC-PW2’s RF input connector set to the RX side (**INPUT** indicator lights green) or OFF (**INPUT** indicator is OFF), **INH** is displayed on the exciter’s screen.

When the exciter tries to transmit, “TX Inhibit” is displayed and cannot transmit.

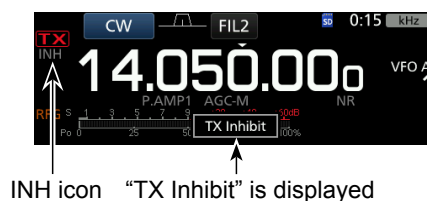

INH icon “TX Inhibit” is displayed

Section 14 MAINTENANCE

Cleaning	14-2
Replacing fuse.....	14-2
◇ DC power cable fuses.....	14-2
◇ Circuitry fuse.....	14-2
Touch screen calibration function	14-3
Resetting	14-4
◇ Partial reset.....	14-4
◇ All reset.....	14-4
Troubleshooting.....	14-5

Cleaning



DO NOT use harsh solvents such as benzine or alcohol when cleaning, because they will damage the transceiver surfaces.



If the transceiver becomes dusty or dirty, wipe it clean with a dry, soft cloth.

Replacing fuse

If a fuse blows, or the transceiver stops functioning, find and repair the cause of the problem. Then replace the damaged fuse with a new, adequately rated fuse.

The fuses are installed in the DC power cable and the circuitry in the body, to protect the transceiver.

- DC power cable fusesATC 25 A /30 A*
 - Circuitry fuseAPS 5 A
- *The fuse type differs, depending on the transceiver version.

⚠ WARNING!

- Disconnect the DC power cable from the transceiver before replacing the fuse.
- **NEVER** use fuses that are not specified.

CAUTION: When you remove a fuse, use longnose pliers to protect your fingers and the fuse holders.

◇ DC power cable fuses

See the following illustration to replace the DC power cable fuses.

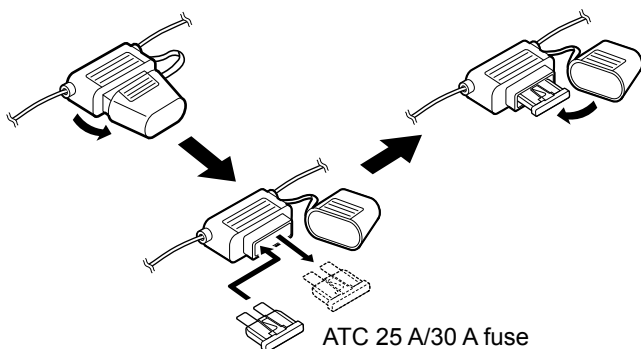

◇ Circuitry fuse

1. Remove the 14 screws, then remove the cover.

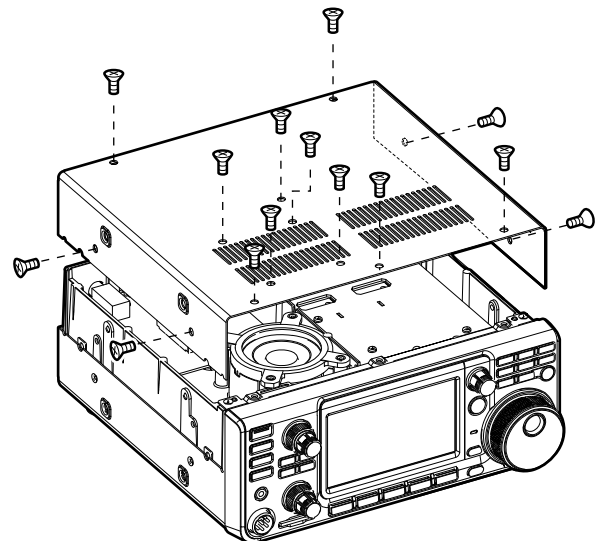

2. Replace the circuitry fuse as shown below.

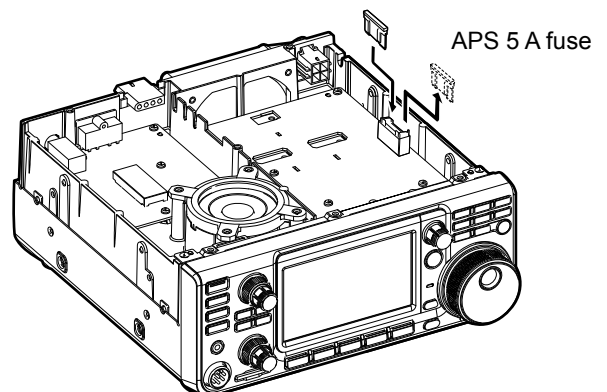

3. Replace the cover and the screws.

Touch screen calibration function

When no screen action occurs, or a different function is activated after touching the screen, the touched point and the detected point may be different. In that case, the Touch screen calibration function helps to correct the touch screen sensing accuracy.

1. Open the OTHERS screen.
MENU » SET > Others
2. Touch “Touch Screen Calibration.”
 - A dot appears on the screen.

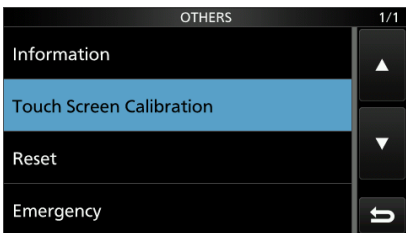

3. Touch the dot that appears on the screen.
 - A new dot appears in another position.
4. Repeat step 3.
 - ① When the calibration is complete, the transceiver returns to the OTHERS screen.

TIP: When the touch screen is not accurate, and you cannot access the OTHERS screen.

Do the following steps to correct the touch screen sensing accuracy.

1. Turn OFF the transceiver.
2. While holding down MENU and EXIT, push POWER to display the “Touch Window Calibration” screen, and then release MENU and EXIT.

A screenshot of the 'Touch Window Calibration' screen. A small white dot is visible in the top-left corner of the screen. A label 'dot' with a line pointing to the dot is positioned above the screen. The text 'Touch Window Calibration' is centered on the screen.

3. Touch the dot that appears on the screen.
 - A new dot appears in another position.
4. Repeat step 3.
 - When the calibration is complete, the transceiver automatically restarts.
5. Touch the frequency readout or a key on the touch screen to confirm that the touch screen is working correctly.

Resetting

Occasionally, erroneous information may be displayed. This may be caused by static electricity or by other factors.

If this problem occurs, turn OFF the transceiver. After waiting a few seconds, turn ON the transceiver.

If the problem still exists, perform a Partial reset as described to the right.

If the problem still exists after a Partial reset, perform an All reset as described to the right.

NOTE: An All reset clears all data and returns all settings to their factory defaults. Save memory channel content, setting status, and so on, onto an SD card before the All reset. (p. 8-4)

After performing the partial reset

A Partial reset resets operating settings to their default values (VFO frequency, VFO settings, menu contents) without clearing the items listed below:

- Memory channel contents (Section 9)
- MY Call (p. 13-5)
- Memory Keyer (p. 4-19)
- RTTY memory (p. 4-24)
- User Band Edge (p. 3-7)
- REF Adjust (p. 13-4)
- Fixed Edges (p. 5-7)
- PRESET memory content (p. 13-6)

After performing the All reset

All reset clears all data and returns all settings to their factory defaults.

Memory channel contents, filter setting and so on will all be cleared, so you will need to rewrite your operating settings, unless you have a backup.

When you cannot enter the Set mode

If a touch screen operation error or an unexpected operation occurs, you cannot enter the Set mode. In that case, perform the All reset as described below:

1. Turn OFF the transceiver.
2. While holding down **CLEAR** and **V/M**, push **POWER**.

TIP: If the transceiver is automatically turned ON and cannot perform All reset when connected to an external power supply, reconnect the transceiver to the external power supply while holding down **CLEAR** and **V/M**.

◇ Partial reset

1. Open the RESET screen.
MENU » **SET > Others > Reset**
2. Touch “Partial reset.”
• The confirmation screen is displayed.



3. Touch [Yes].
① After the resetting, the default VFO mode screen is displayed.

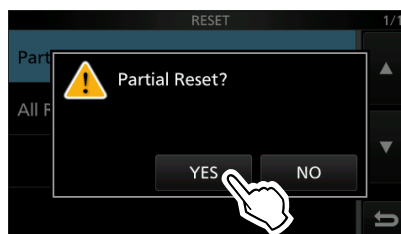

◇ All reset

1. Open the RESET screen.
MENU » **SET > Others > Reset**
2. Touch “All reset.”
• The confirmation screen is displayed.

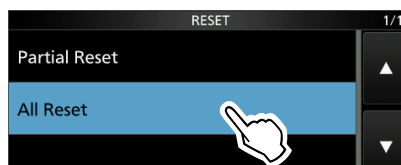

3. Touch [NEXT].



4. After carefully reading the displayed message, touch [YES] to perform the All reset.
① After the resetting, the default VFO mode screen is displayed.



Troubleshooting

The following chart is designed to help you correct problems which are not equipment malfunctions.

If you are unable to locate the cause of a problem, or solve it through the use of this chart, contact your nearest Icom Dealer or Service Center.

PROBLEM	POSSIBLE CAUSE	SOLUTION	REF.
Power does not come on when POWER is pushed.	Power cable is improperly connected.	Reconnect the DC power cable correctly.	p. 2-4
	The external power supply is turned OFF.	Turn ON the external power supply.	p. 2-4
	The DC power cable fuses or circuitry fuse are blown.	Find and repair the cause of the problem and then replace the damaged fuse with a new one.	p. 14-2
No sound is heard from the speaker.	Audio level is too low.	Rotate (AF↻RF/SQL) (inner) clockwise to obtain a suitable listening level.	p. 3-2
	The squelch is closed.	Rotate (AF↻RF/SQL) (outer) to the 12 o'clock position to open the squelch.	p. 3-10
	The tone squelch is ON in the FM mode.	Turn OFF the Tone squelch.	p. 4-30
	An external speaker or headphones are connected to [PHONES] jack.	Disconnect the head-phone or external speaker.	p. 2-2
	The external speaker cable is cut.	Check the external speaker cable and repair it.	—
Sensitivity is too low, and only strong signals can be heard.	The attenuator is activated.	Turn OFF the attenuator in the FUNCTION screen.	p. 4-3
	The squelch is closed.	Rotate (AF↻RF/SQL) (outer) to 12 o'clock position to open the squelch.	p. 3-10
	The antenna is defective or the coaxial cable connector is shorted or cut.	Repair the problem and then reconnect to the antenna connector.	p. 2-3
	You are using an antenna not suitable for the band you have selected.	Connect an antenna suitable for the operating frequency. Hold down TUNER to tune the antenna.	p. 2-3 p. 11-2
No power output or the output power is too low.	The operating frequency is outside a ham band.	Set the frequency to a ham band.	p. 3-4
	The modulation input signal level is set too low.	Adjust the microphone gain in the Multi-function menu.	p. 3-11
	The microphone is bad, or the [MIC] connector is shorted.	Try to transmit in the FM, CW, or RTTY mode to check whether the microphone or the transceiver has a problem.	p. 3-3
	The antenna SWR is more than 3:1.	Adjust the antenna for an SWR of less than 3:1.	p. 11-2
	The antenna is not properly tuned.	Hold down TUNER for 1 second to tune the antenna.	p. 11-2
	TX power is set too low.	Adjust the RF POWER in the Multi-function menu.	p. 3-11

14 MAINTENANCE

Troubleshooting

PROBLEM	POSSIBLE CAUSE	SOLUTION	REF.
The transceiver automatically switches to transmit while receiving.	The VOX function is ON.	Push VOX/BK-IN to turn OFF the VOX function	p. 4-10
	The VOX gain is set too high.	Adjust the VOX gain.	p. 4-10
Cannot contact with another station even if receiving and transmitting seem successful.	The Split function is activated. (The transmit and receive frequencies are different.)	Push SPLIT to turn OFF the function.	p. 4-13
	The RIT function or the ΔTX function is ON and a different receive or transmit frequency is set.	Push RIT or ΔTX to turn OFF the function.	p. 4-3 p. 4-11
Received audio in the SSB mode is unclear or distorted.	The incorrect sideband is selected.	Toggle between USB and LSB.	p. 3-3
	The PBT function is activated.	Hold down TWIN PBT CLR to clear the settings.	p. 4-5
Transmit signal is unclear or distorted in the SSB mode.	The transceiver MIC gain is too high.	Adjust the MIC gain level so that the meter reading swings between 30 and 50% of the ALC scale.	p. 3-11
	The MIC gain of the desktop microphone is too high.		
The displayed frequency does not properly change by rotating MAIN DIAL .	The Dial Lock function is activated.	Hold down SPEECH PRO to turn the Dial Lock function OFF.	p. 3-10
Programmed scan does not start.	The same frequencies have been set in scan edge memory channels P1 and P2.	Set different frequencies in scan edge memory channels P1 and P2.	p. 10-3
Memory scan does not start.	0 or only 1 memory channel is set.	Set at least 2 memory channels.	p. 9-3
Select memory scan does not start.	0 or only 1 memory channel is designated as a Select channel.	Designate at least 2 memory channels as Select channels for the scan.	—
The contents of a selected memory channel is not changed.	The contents of the selected memory channel were changed, but they are not saved.	When you want to save the changed settings, touch [MW] for 1 second to write them into the memory channel in the VFO/MEMORY screen.	p. 9-3
Cannot hear the speech after pushing SPEECH PRO .	The speech level is too low.	Adjust the speech level in the Speech setting.	p. 12-6
The antenna SWR is too high.	The antenna is not properly tuned.	Adjust the antenna SWR. The antenna SWR should be less than 3.	p. 13-2
	The coaxial cable is not suitable.	Use a coaxial cable whose characteristic impedance is 50 Ω.	p. 17-2
“OVF” is displayed.	Excessively strong signal is received.	Rotate AF-RF/SQL (outer) counter clockwise.	p. 3-10
		Turn ON the attenuator.	p. 4-3
The touch screen is not working correctly.	The touched point and the detected point may be different.	Calibrate the touch screen.	p. 14-3

Section 15 UPDATING THE FIRMWARE

General.....	15-2
◇ About the firmware updating.....	15-2
◇ Checking the firmware version	15-2
◇ Preparation	15-3
◇ Unzipping the firmware file	15-4
Updating the firmware	15-5

General

◇ About updating the firmware

You can update the IC-7300's firmware using an SD card. Updating the firmware adds new functions and improves performance parameters.

You can download the latest firmware from the Icom website.

<https://www.icomjapan.com/support/>

◇ Checking the firmware version

You can check the firmware version in the Set mode.

1. Open the INFORMATION screen.

MENU » **SET > Others > Information**

2. Touch "Version."

• The firmware version is displayed.

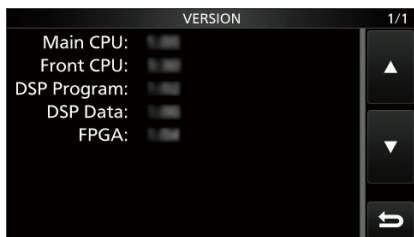
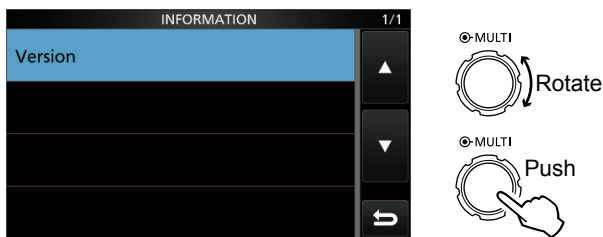

The VERSION screen

TIP: You also can check the firmware version in the Opening screen when you turn ON the transceiver.



The firmware version is displayed.

15 UPDATING THE FIRMWARE

General

◇ Preparation

Access the following URL and download the firmware file.

<https://www.icomjapan.com/support/>

① These instructions are based on Microsoft® Windows® 10.

1. Click the **“Firmware Updates/Software”** link.



2. Enter “IC-7300” into the Search box, and then click **[Search]**.

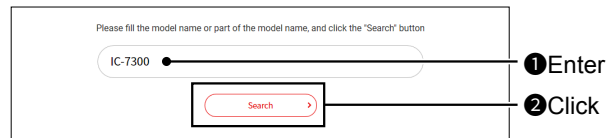

3. Click the desired firmware file link.
4. Read “Regarding this Download Service” carefully. Click **“Agree,”** and then click **[Download]**.

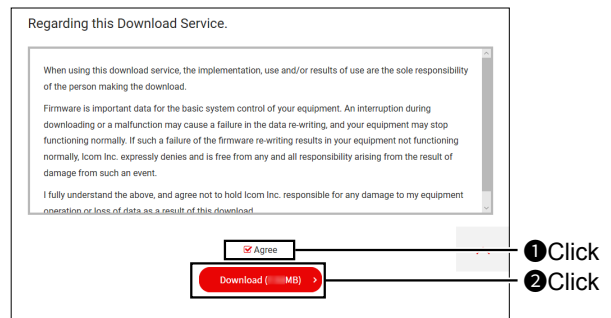

5. Click **“Save as”** in the displayed File Download dialog.



6. Select the location where you want to save the firmware, and then click **[Save]** in the displayed File Download dialog.

- The file starts downloading.
- The firmware and the firm utility are compressed in a “zip” format folder. Unzip it before use.

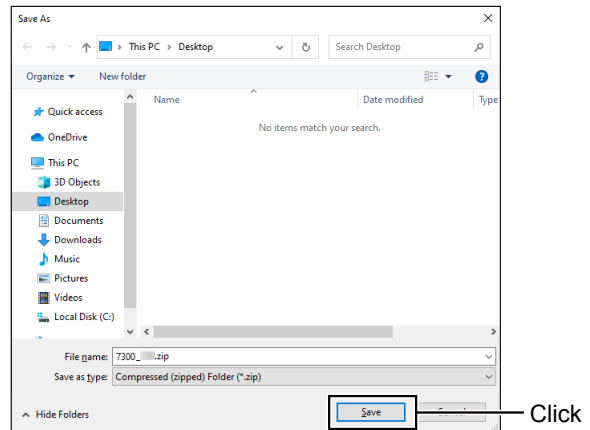

General

◇ Unzipping the firmware folder

1. Right-click the downloaded firmware folder (zip format).
 - Right-click menu is displayed.
2. Click “Extract All...”
 - After unzipping, a folder is created in the same location as the downloaded folder.
 - ① In the “7300_*” folder, “7300_*.dat” is created.
 - * represents the release number.

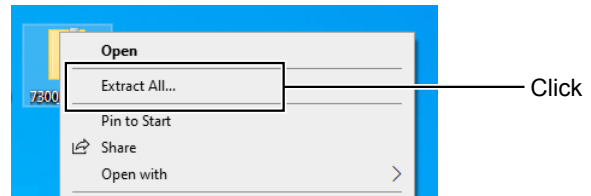

Updating the firmware

IMPORTANT: To update the firmware, first format your SD card using the IC-7300. (p. 8-3) Then copy the downloaded firmware data from your PC to the SD card. (p. 8-4)

CAUTION: NEVER turn OFF the transceiver while updating the firmware. If you turn OFF the transceiver, or if a power failure occurs while updating, the transceiver firmware will be damaged and you will have to send the transceiver back to the nearest Icom distributor for repair. This type of repair is out of warranty, even if the transceiver warranty period is still valid.

TIP: BE SURE to unzip the downloaded file. See “Unzipping the firmware file (p. 15-4)” for details.

- Copy the downloaded firmware data into the IC-7300 folder on an SD card.

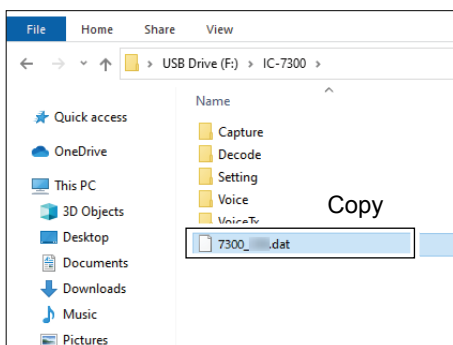

- Insert the SD card into the transceiver's [SD CARD] slot.
- On the Set mode menu screen, display the SD CARD screen.

MENU » **SET > SD card**

- Select “Firmware Update.”
- The firmware update agreement screen is displayed.

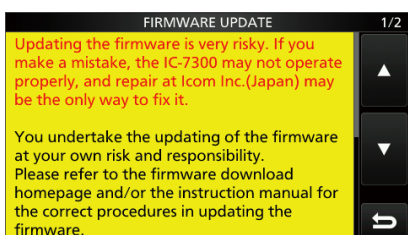
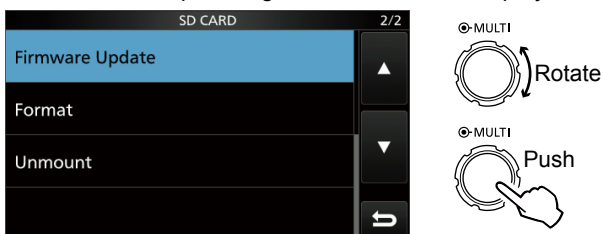

The Firmware Update Agreement screen

- Touch [Ù] or [Ú] to scroll the screen.
 - Carefully read all the displayed precautions.
- After you read and agree with all the precautions, touch [YES].
 - The confirmation dialog is displayed. When you touch [YES], the backup file is made on the SD card, and then the Firmware selection screen is displayed.
 - When you want to cancel the updating, touch [NO].



- Touch the Firmware (Example: 7300_101).
 - The final confirmation screen is displayed.
 - Carefully read all the displayed precautions.

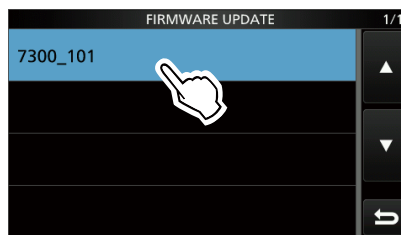

- After you read and agree with all the precautions, touch [YES] for 1 second.



- The updating starts.
- If you want to cancel the updating, touch [NO].

(Continued on the next page.)

15 UPDATING THE FIRMWARE

Updating the firmware

The screen changes as shown below during the updating.

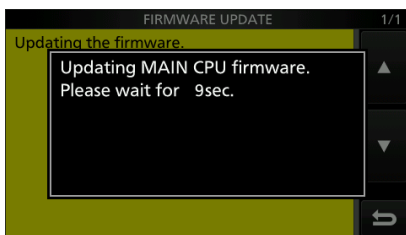
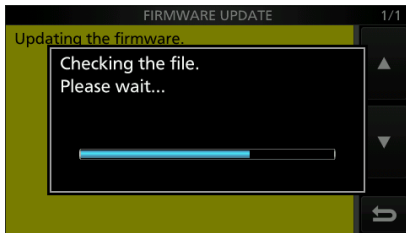

- ① The IC-7300 reads the firmware file from the SD card and writes it to the main CPU and DSP/FPGA.
 - ① Downloading and loading status are displayed in the dialogs.
9. “Firmware updating has completed.” is displayed in the dialog.
- The IC-7300 will automatically restart.
 - ① After the updating finishes, the operating screen is displayed.

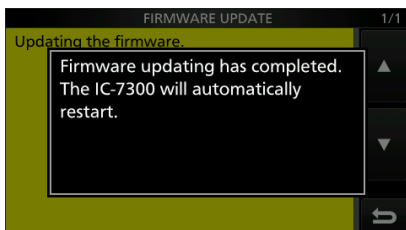

TIP: To check the firmware version after the updating, see “Checking the firmware version (p. 15-2)” for details.

Section 16 SPECIFICATIONS

◇ General	16-2
◇ Transmitter	16-2
◇ Receiver	16-3
◇ Antenna tuner	16-3

16 SPECIFICATIONS

◇ General

- Frequency coverage (unit: MHz):

Receiver	0.030000~74.800000* ¹
Transmitter	1.800000~ 1.999999* ²
	3.500000~ 3.999999* ²
	5.255000~ 5.405000* ²
	7.000000~ 7.300000* ²
	10.100000~10.150000* ²
	14.000000~14.350000* ²
	18.068000~18.168000* ²
	21.000000~21.450000* ²
	24.890000~24.990000* ²
	28.000000~29.700000* ²
	50.000000~54.000000* ²
	70.000000~70.500000* ²

*¹ Some frequency ranges are not guaranteed.

*² Depending on the transceiver version.

- Operating modes: USB/LSB (J3E), CW (A1A), RTTY (F1B), AM (A3E) and FM (F3E)
- Number of memory channels: 101 (including 2 scan edges)
- Antenna impedance: 50 Ω Unbalanced
- Power supply requirement: 13.8 V DC (±15%)
- Operating temperature range: -10°C to +60°C, +14°F to +140°F
- Frequency stability: Less than ±0.5 ppm (-10°C to +60°C, +14°F to +140°F)
- Frequency resolution: 1 Hz (minimum)
- Power consumption:

Receive	Standby	0.9 A typical
	Maximum audio	1.25 A
Transmit	Maximum power	21.0 A
- Dimensions (projections not included): 240 (W)×94 (H)×238 (D) mm, 9.4 (W)×3.7 (H)×9.4 (D) in
- Weight (approximate): 4.2 kg, 9.3 lb

◇ Transmitter

- Transmit output power:

HF and 50 MHz bands	
SSB/CW/RTTY/FM	2~100 W
AM	1~25 W
70 MHz band* ²	
SSB/CW/RTTY/FM	2~50 W
AM	1~12.5 W

*² Depending on the transceiver version.
- Modulation system:

SSB	P.S.N. modulation
AM	Low power modulation
FM	Reactance modulation
- Spurious emission:

Harmonics	Less than -50 dB (1.8~28 MHz)
	Less than -63 dB (50 MHz band)
	Less than -60 dB (70 MHz band)
Out-of-band emission	Less than -40 dB (1.8~28 MHz)
	Less than -60 dB (50 MHz band)
	Less than -60 dB (70 MHz band)
- Carrier suppression: More than 50 dB
- Unwanted sideband suppression: More than 50 dB
- Microphone impedance: 600 Ω

16 SPECIFICATIONS

◇ Receiver

- Receive system: Direct sampling superheterodyne
- Intermediate frequency: 36 kHz
- Sensitivity (Filter: SOFT):
 - SSB/CW (BW=2.4 kHz, 10 dB S/N)
 - 1.8 ~ 29.999999 MHz Less than -123 dBm (0.16 μV) (P.AMP1 ON)
 - 50 MHz band Less than -125 dBm (0.13 μV) (P.AMP2 ON)
 - 70 MHz band*² Less than -123 dBm (0.16 μV) (P.AMP2 ON)
 - AM (BW=6 kHz, 10 dB S/N)
 - 0.5 ~ 1.8 MHz Less than -85 dBm (12.6 μV) (P.AMP1 ON)
 - 1.8 ~ 29.999999 MHz Less than -101 dBm (2.0 μV) (P.AMP1 ON)
 - 50 MHz and 70 MHz bands Less than -107 dBm (1.0 μV) (P.AMP2 ON)
 - FM (BW=15 kHz, 12 dB SINAD)
 - 28.0 ~ 29.7 MHz Less than -113 dBm (0.5 μV) (P.AMP1 ON)
 - 50 MHz and 70 MHz bands Less than -119 dBm (0.25 μV) (P.AMP2 ON)
- *² Depending on the transceiver version.
- Sensitivity for European versions (Filter: SOFT)
 - SSB (BW=2.4 kHz, 12 dB SINAD)
 - 1.8 ~ 2.999999 MHz Less than 10 dBμV emf (P.AMP 1 ON)
 - 3.0 ~ 29.999999 MHz Less than 0 dBμV emf (P.AMP 1 ON)
 - 50 MHz and 70 MHz bands Less than -6 dBμV emf (P.AMP 2 ON)
 - AM (BW=4 kHz, 60% Modulation, 12 dB SINAD)
 - 1.8 ~ 2.999999 MHz Less than 16 dBμV emf (P.AMP 1 ON)
 - 3.0 ~ 29.999999 MHz Less than 6 dBμV emf (P.AMP 1 ON)
 - 50 MHz and 70 MHz bands Less than 0 dBμV emf (P.AMP 2 ON)
 - FM (BW=7 kHz, 60% Modulation, 12 dB SINAD)
 - 28.0 ~ 29.7 MHz Less than 0 dBμV emf (P.AMP 1 ON)
 - 50 MHz and 70 MHz bands Less than -6 dBμV emf (P.AMP 2 ON)
- Squelch sensitivity (threshold):
 - SSB Less than -92 dBm (5.6 μV)
 - FM Less than -117 dBm (0.3 μV)
 (HF band: P.AMP1 ON, 50 MHz band: P.AMP2 ON)
- Selectivity (Filter: SHARP):
 - SSB (BW=2.4 kHz)
 - More than 2.4 kHz/-6 dB
 - Less than 3.4 kHz/-40 dB
 - CW (BW=500 Hz)
 - More than 500 Hz/-6 dB
 - Less than 700 Hz/-40 dB
 - RTTY (BW=500 Hz)
 - More than 500 Hz/-6 dB
 - Less than 800 Hz/-40 dB
 - AM (BW=6 kHz)
 - More than 6.0 kHz/-6 dB
 - Less than 10 kHz/-40 dB
 - FM (BW=15 kHz)
 - More than 12.0 kHz/-6 dB
 - Less than 22 kHz/-40 dB
- Spurious and image rejection: More than 70 dB (except for ADC aliasing)
- Audio output power: More than 2.5 W (8 Ω load, 1 kHz, 10% distortion)
- AF output impedance: 8 Ω
- RIT variable range: ±9.999 kHz

◇ Antenna tuner

- Tunable impedance range: 16.7~150 Ω (unbalanced) (less than 3:1 VSWR)
- Tuning accuracy: Less than 1.5:1 VSWR
- Tuning time (approximate):
 - 2~3 seconds (average)
 - 15 seconds (maximum)

① All stated specifications are typical and subject to change without notice or obligation.

Section 17 OPTIONS

Options	17-2
Mounting the MB-118	17-3
Attaching the MB-123	17-3

Options

IC-PW2 LINEAR AMPLIFIER

HF/50 MHz all band 1 kW linear amplifier including an automatic antenna tuner. An optional OPC-599 is required for the connection.



AH-730 AUTOMATIC ANTENNA TUNER

Automatic antenna tuner to tune a long wire antenna for base, portable, or mobile HF/50 MHz operation.



AH-740 AUTOMATIC TUNING ANTENNA

High performance, automatic high-speed tuning antenna.

The optional AH-5NV NVIS KIT is available.



SM-50

DESKTOP MICROPHONE

Dynamic microphone with [UP]/[DOWN] switches.



SM-30

DESKTOP MICROPHONE

Desktop microphone with a low frequency cut function.



SP-41

EXTERNAL SPEAKER

Designed for base station operation.



- **AH-5NV** NVIS KIT
Use with the AH-740.
- **AH-710** FOLDED DIPOLE ANTENNA
Covers 2 to 30 MHz wide frequency range.
Element length: 24.5 m (80.4 ft)
Coaxial cable (supplied): 30 m (98.4 ft)
- **HM-219** MICROPHONE
The same as supplied.
- **MB-118** MOUNTING BRACKET
To mount the transceiver inside a vehicle.
- **MB-123** CARRYING HANDLE
- **OPC-599** ADAPTER CABLE
13-pin ACC connector adaptor to 7-pin + 8-pin ACC connectors.

- **RS-BA1 Version 2** IP REMOTE CONTROL SOFTWARE

NOTE: To remotely control transceivers using the RS-BA1, BE SURE to comply with your local regulations.

- **SP-33** EXTERNAL SPEAKER
Designed for base station operation.
- **SP-35** EXTERNAL SPEAKER
Designed for mobile operation.
- **SP-38** EXTERNAL SPEAKER
Designed to match the IC-7300.

About the free download software	
ST-4003A (For Android devices)	TIME ADJUSTMENT SOFTWARE
ST-4003W (For Windows)	TIME ADJUSTMENT SOFTWARE

You can download each manual and guide from the Icom website.
<https://www.icomjapan.com/support/>

Before using, read each manual and guide, and use it according to the instructions.

① To add or expand a function, or to improve the performance, the software version may be upgraded. Before you update your software version, see the instructions and cautions described on the Icom website.

Mounting the MB-118

Mount the MB-118 MOUNTING BRACKET to a place where it can be firmly attached.

- ① We recommend that you periodically check whether the screws are loose or not, especially after a long period of use.

NOTE:

- Before mounting the MB-118, carefully read PRECAUTIONS (p. vi) and decide the mounting place.
- DO NOT use bolts other than the ones that are supplied with the MB-118. Other bolts (longer than 8 mm/0.31 in) may damage the internal units.

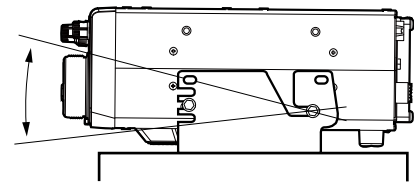
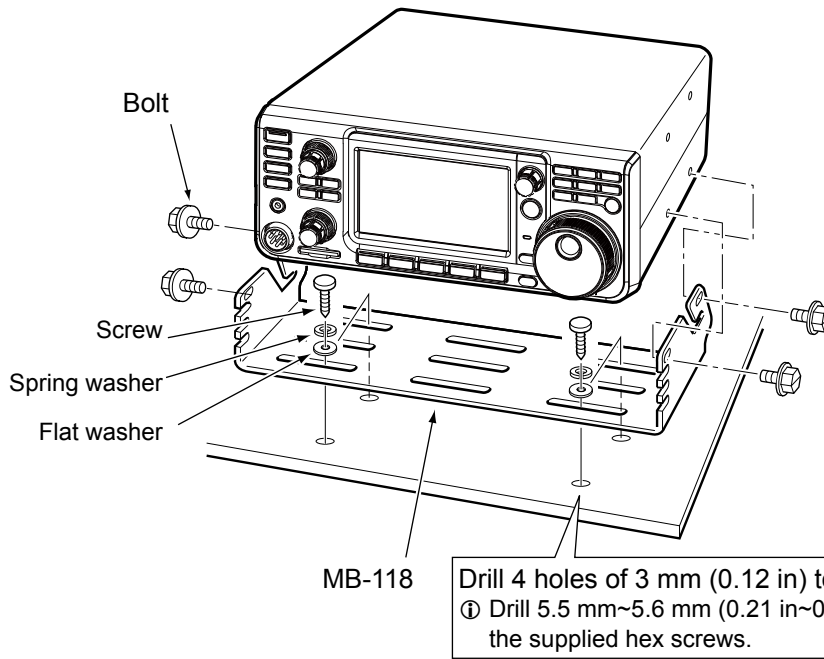

Adjust for the best viewing angle.

Attaching the MB-123

The optional MB-123 CARRYING HANDLE with the rubber feet is convenient for carrying the transceiver.

1. Attach the rubber feet supplied with the MB-123 to the transceiver.
 - ① To firmly attach, push-in the center part of the rubber feet.
2. Attach the carrying handle using the supplied screws as shown to the right.

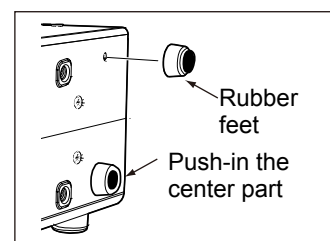

NOTE: DO NOT use other than the screws supplied with the MB-123.

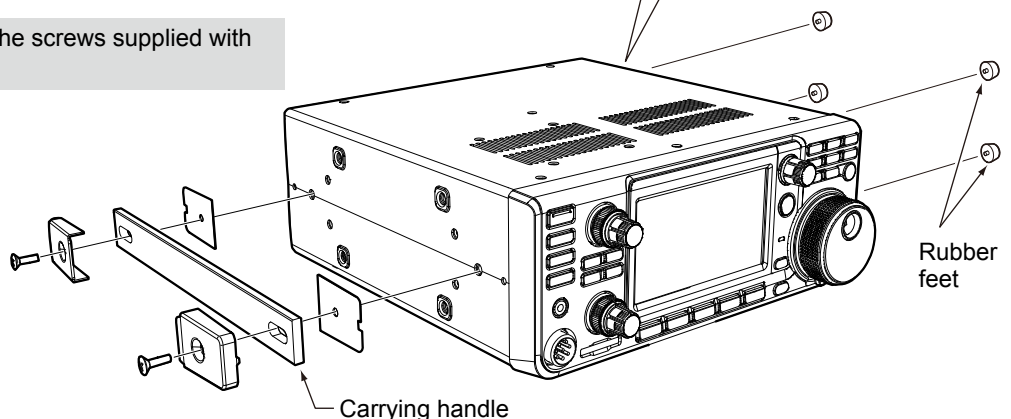

ACC socket.....	18-2
◇ OPC-599 ACC conversion cable pin assignments	18-3
Microphone connector.....	18-3
◇ External keypad	18-3
KEY jack	18-4
EXT-SP jack	18-4
REMOTE jack.....	18-4
ALC jack	18-4
SEND jack	18-4
PHONES jack.....	18-4
DC power socket	18-4

ACC socket

Connects to external equipment or a PC to control the external unit or to control the transceiver.

• ACC socket

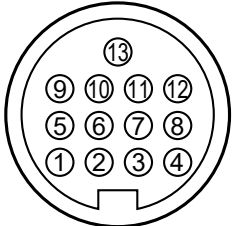
ACC	PIN No.	NAME	DESCRIPTION	SPECIFICATIONS	
<div style="text-align: center;">  <p>13-pin</p> <p>Rear panel view</p> <p>① brown ⑧ gray ② red ⑨ white ③ orange ⑩ black ④ yellow ⑪ pink ⑤ green ⑫ light blue ⑥ blue ⑬ light green ⑦ purple</p> <div style="border: 1px solid black; padding: 2px; width: fit-content;"> Color refers to the cable strands of the supplied cable. </div> </div>	1	8 V	Regulated 8 V output. (Used as the reference voltage for the band voltage.)	Output voltage: 8 V ±0.3 V Output current: Less than 10 mA	
	2	GND	Connects to ground.	—	
	3	SEND*1	Input/output pin.	An external unit controls the transceiver. When this pin goes to ground, the transceiver transmits. The pin goes low when the transceiver transmits.	Input voltage (RX): 2.0 to 20.0 V Input voltage (TX): -0.5 to +0.8 V Current flow: Maximum 20 mA Output voltage (TX): Less than 0.1 V Current flow: Maximum 200 mA
	4	BDT	Not used.	—	
	5	BAND	Band voltage output. (Varies with the selected amateur band)	Output voltage: 0 to 8.0 V	
	6	ALC	ALC voltage input.	Input level: -4 to 0 V Input impedance: More than 3.3 kΩ	
	7	NC	—	—	
	8	13.8 V	13.8 V output when power is ON.	Output current: Maximum 1 A	
	9	TKEY	Not used.	—	
	10	FSKK	Controls RTTY keying.	High level: More than 2.4 V Low level: Less than 0.6 V Output current: Less than 2 mA	
	11	MOD	Modulator input.	Input impedance: 10 kΩ Input level: 100 mV rms*3	
	12	AF/IF (IF=12 kHz)*2	Fixed AF detector or receive IF (12 kHz) signal output.	Output impedance: 4.7 kΩ Output level: 100 ~ 300 mV rms*4	
	13	SQL S	Squelch output. Grounded when the squelch opens.	SQL open: Less than 0.3 V/5 mA SQL closed: More than 6.0 V/100 μA	

*1 When the SEND terminal controls an inductive load, such as a relay, a counter-electromotive force can malfunction or damage the transceiver. To prevent this, we recommend adding a switching diode, such as an 1SS133, on the load side of the circuit to absorb the counter-electromotive force. When the diode is added, a delay in relay switching may occur. Be sure to check its switching action before operating.

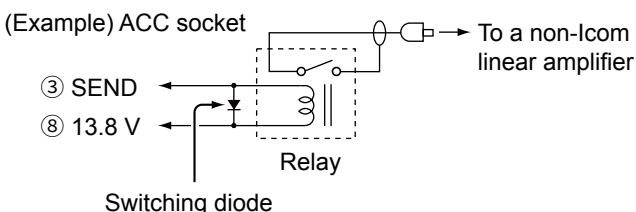

*2 You can change the pin 12 setting in the “ACC/USB Output Select” item on the CONNECTORS set screen. If the pin is set to IF, the transceiver outputs a 12 kHz IF signal from [ACC]. In that case, you can listen to the DRM broadcast with the application software receiver that is installed into your PC.

*3 You can change the input level in the “ACC MOD Level” item on the CONNECTORS set screen. (p. 12-9) 100 mV rms is at the 50% (default) setting.

*4 You can change the output level in the “ACC/USB AF Output Level” item on the CONNECTORS set screen. (p. 12-9) Approximately 200 mV rms is at the 50% (default) setting.

18 CONNECTOR INFORMATION

ACC socket

◇ OPC-599 ACC conversion cable pin assignments

The OPC-599 ACC conversion cable connects between a 13 pin [ACC] socket and 7 pin and 8 pin sockets.

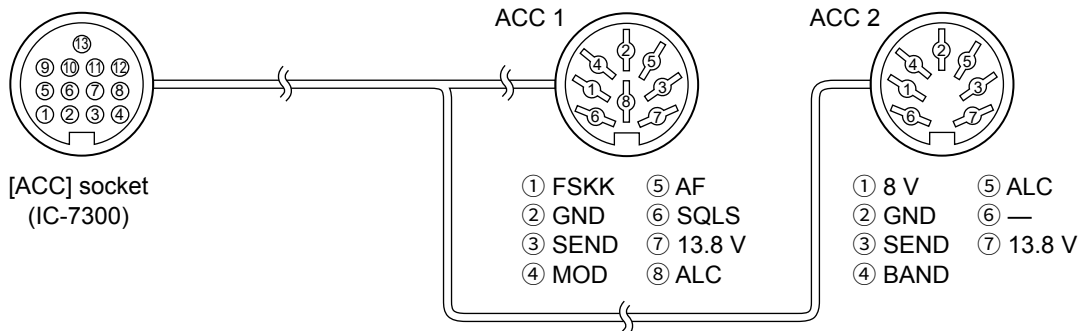

Microphone connector

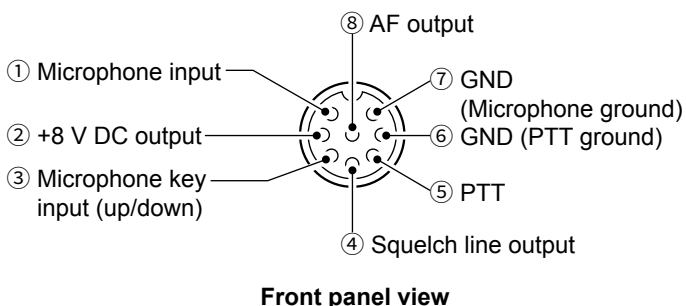

PIN No.	DESCRIPTION
①	Microphone input (Impedance: 600 Ω)
②	+8 V DC output (Maximum 10 mA)
③	Up: Ground Down: Ground through 470 Ω
④	Grounded when the squelch opens.
⑤	PTT*
⑥	PTT ground
⑦	Microphone ground
⑧	AF output (varies with the [AF] control.)

* The [PTT] switch function can be customized in the following item.

MENU » **SET > Connectors > PTT Port Function**

◇ External keypad

A circuit is used to output memory content from 4 memories. You can output desired memory content such as that from a CW Memory keyer (M1 ~ M4), Voice memory (T1 ~ T4), RTTY Memory (RT1 ~ RT4) to be transmitted.

- Push a switch to send the memory information.
- Hold down the switch for 1 second to repeatedly send the memory information.

① To use the external keypad, turn ON the following items in the CONNECTORS set screen. (p. 12-10)

MENU » **SET > Connectors > External Keypad**

- VOICE: ON
- KEYER: ON
- RTTY: ON

① The External keypad is not supplied by Icom. (User supplied)

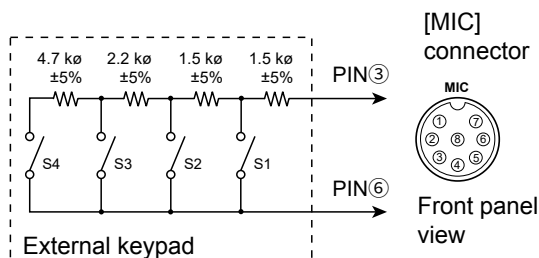

KEY jack

Connects to a CW straight key or a paddle:
6.35 mm (1/4 in) (d)

When connecting a CW straight key.

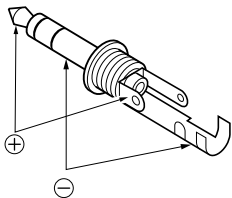

When connecting a CW paddle and using the internal electronic keyer.

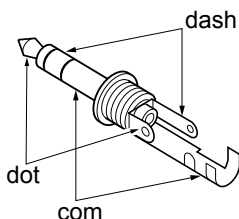

EXT-SP jack

EXT-SP Connects to an external speaker:
3.5 mm (1/8 in) (d)
• Output impedance: 4 ~ 8 Ω
• Output level: More than 2.5 W at 10% distortion into an 8 Ω load.

REMOTE jack

REMOTE Used for control the IC-PW2 using the CI-V command.
3.5 mm (1/8 in) (d)

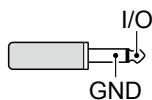

ALC jack

ALC Connects to the ALC output jack of a non-Icom linear amplifier. (RCA Plug)
• Control voltage: -4 ~ 0 V



SEND jack

SEND The terminal goes low when the transceiver transmits. (RCA Plug)
This terminal is used to control an external non-Icom linear amplifier.
T/R control voltage and current must be less than 16 V DC and 0.5 A.



PHONES jack

PHONES Connects to standard stereo headphones:
3.5 mm (1/8 in) (d)
• Output impedance: 8 ~ 16 Ω
• Output level: More than 5 mW into an 8 Ω load.



DC power socket

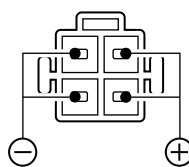

Rear panel view

Accepts the regulated DC power for 13.8 V DC ±15% through the supplied DC power cable.

⚠ WARNING! NEVER reverse the DC power cable polarity.

Section 19 CONTROL COMMAND

Remote control (CI-V) information.....	19-2
◇ CI-V connection	19-2
◇ Preparing	19-2
◇ Data format	19-2
◇ Command table	19-3
◇ Data content description	19-9

Remote control (CI-V) information

◇ CI-V connection

The transceiver's operating frequency, mode, VFO and memory selection, can be remotely controlled using a PC.

- Use a USB cable (user supplied) to connect the IC-7300 and the PC (controller).

The required USB driver and driver installation guide can be downloaded from the Icom web site.

https://www.icomjapan.com/support/firmware_driver/

①The download procedure on the web page may be changed without notice.

Connection example

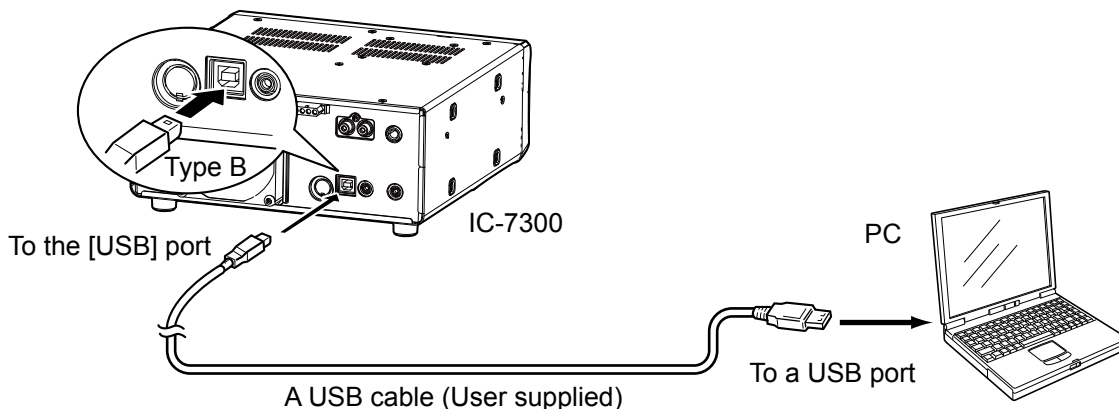

①Make the connection as short as possible. The transceiver may not be recognized by the controller, depending on the USB cable length.

◇ Preparing

The Icom Communications Interface V (CI-V) is used for remote control.

To control the transceiver, first set its address, data communication speed, and transceive function. These settings are set in Set mode.

◇ Data format

The CI-V system can be written using the following data formats. Data formats differ according to command numbers. A data area or sub command is added for some commands.

Controller to IC-7300

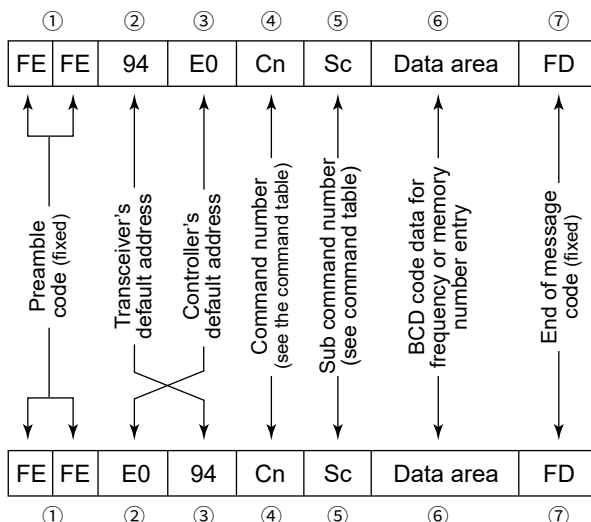

IC-7300 to controller

OK message to controller

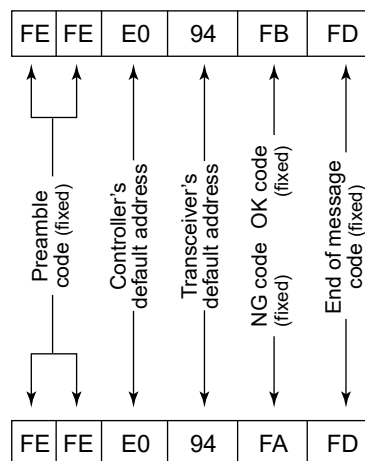

NG message to controller

19 CONTROL COMMAND

Remote control (CI-V) information

◇ Command table

Cmd.	Sub cmd.	Data	Description
00		p. 19-9	Send frequency data (transceive)
01		p. 19-9	Send mode data (transceive)
02		p. 19-9	Read band edge frequencies
03		p. 19-9	Read operating frequency
04		p. 19-9	Read operating mode
05		p. 19-9	Set operating frequency
06		p. 19-9	Operating mode selection for transceive
07			Select the VFO mode
	00		Select VFO A
	01		Select VFO B
	A0		Equalize VFO A and VFO B
	B0		Exchange VFO A and VFO B
08			Select the Memory mode
		00 01 to 00 99	Select the Memory channel *(00 01=M-CH01, 00 99=M-CH99)
		01 00	Select program scan edge channel P1
		01 01	Select program scan edge channel P2
09			Memory write
0A			Memory copy to VFO
0B			Memory clear
0E	00		Scan stop
	01		Programmed/memory scan start
	02		Programmed scan start
	03		F scan start
	12		Fine programmed scan start
	13		Fine ΔF scan start
	22		Memory scan start
	23		Select memory scan start
	A1		Select ΔF scan span ±5 kHz
	A2		Select ΔF scan span ±10 kHz
	A3		Select ΔF scan span ±20 kHz
	A4		Select ΔF scan span ±50 kHz
	A5		Select ΔF scan span ±100 kHz
	A6		Select ΔF scan span ±500 kHz
	A7		Select ΔF scan span ±1 MHz
	B0		Set as non-select channel
	B1		Set as select channel (The previously set number by CI-V is set after turning power ON, or "1" is selected if no selection is performed.)
		01 to 03	Set as select channel *(01=SEL1, 02=SEL2, 03=SEL3)
	B2	00 to 03	Set for select memory scan *(00=ALL, 01=SEL1, 02=SEL2, 03=SEL3)
	D0		Set Scan resume OFF
	D3		Set Scan resume ON
0F		00/01	Read Split setting (00=OFF, 01=ON)
	00		Turn the split function OFF
	01		Turn the split function ON
10*		00	Send/read the tuning step OFF
		01	Send/read the 100 Hz tuning step
		02	Send/read the 1 kHz tuning step
		03	Send/read the 5 kHz tuning step
		04	Send/read the 9 kHz tuning step
		05	Send/read the 10 kHz tuning step
		06	Send/read the 12.5 kHz tuning step
		07	Send/read the 20 kHz tuning step
		08	Send/read the 25 kHz tuning step
11*		00/20	Send/read Attenuator *(00=OFF, 20=20dB ON)
13	00		Speech all data with voice synthesizer
	01		Speech the operating frequency and S meter level by voice synthesizer
	02		Speech the operating mode by voice synthesizer
14*	01	00 00 to 02 55	Send/read the AF level *(00 00=min. to 02 55=max.)
	02	00 00 to 02 55	Send/read the RF gain level *(00 00=min. to 02 55=max.)
	03	00 00 to 02 55	Send/read the squelch level *(00 00=min. to 02 55=max.)

Cmd.	Sub cmd.	Data	Description
14*	06	00 00 to 02 55	Send/read the NR level *(00 00=0% to 02 55=100%)
	07	00 00 to 02 55	Send/read inner [TWIN PBT] position *(00 00=max. CCW, 01 28=center, 02 55=max. CW)
	08	00 00 to 02 55	Send/read outer [TWIN PBT] position *(00 00=max. CCW, 01 28=center, 02 55=max. CW)
	09	00 00 to 02 55	Send/read CW pitch *(00 00=300 Hz, 01 28=600 Hz, 02 55=900 Hz; 5 Hz steps)
	0A	00 00 to 02 55	Send/read [RF PWR] position *(00 00=max. CCW, 02 55=max. CW)
	0B	00 00 to 02 55	Send/read [MIC] position *(00 00=max. CCW, 02 55=max. CW)
	0C	00 00 to 02 55	Send/read [KEY SPEED] level *(00 00=6wpm, 02 55=48wpm)
	0D	00 00 to 02 55	Send/read [NOTCH] position *(00 00=max. CCW, 01 28=center, 02 55=max. CW)
	0E	00 00 to 02 55	Send/read the COMP level *(00 00=0 to 02 55=10)
	0F	00 00 to 02 55	Send/read the Break-IN Delay setting *(00 00=2.0d to 02 55=13.0d)
	12	00 00 to 02 55	Send/read NB level *(00 00=0% to 02 55=100%)
	15	00 00 to 02 55	Send/read the Monitor gain *(00 00=0% to 02 55=100%)
	16	00 00 to 02 55	Send/read the VOX gain *(00 00=0% to 02 55=100%)
	17	00 00 to 02 55	Send/read the Anti VOX gain *(00 00=0% to 02 55=100%)
	19	00 00 to 02 55	Send/read BRIGHT level *(00 00=0%, 02 55=100%)
15	01	00/01	Read noise or S-meter squelch status *(squelch close)
	02	00 00 to 02 55	Read S-meter level *(00 00=S0, 01 20=S9, 02 41=S9+60dB)
	05	00/01	Read various squelch function's status *(squelch closed)
	07	00/01	Read the OVF icon status (00=Disappears, 01=Appears)
	11	00 00 to 02 55	Read PO meter level *(00 00=0%, 01 43=50%, 02 13=100%)
	12	00 00 to 02 55	Read SWR meter level *(00 00=SWR1.0, 00 48=SWR1.5, 00 80=SWR2.0, 01 20=SWR3.0)
	13	00 00 to 02 55	Read ALC meter level *(00 00=Min. to 01 20=Max.)
	14	00 00 to 02 55	Read COMP meter level *(00 00=0 dB, 01 30=15 dB, 02 41=30 dB)
	15	00 00 to 02 55	Read Vd meter level *(00 00=0 V, 00 13=10 V, 02 41=16 V)
	16	00 00 to 02 55	Read Id meter level *(00 00=0, 00 97=10, 01 46=15, 02 41=25)
16*	02	00 to 02	Preamp (00=OFF, 01=Preamp 1 ON, 02=Preamp 2 ON)
	12	01 to 03	AGC *(01= FAST, 02= MID, 03=SLOW)
	22	00/01	Noise blanker *(00=OFF, 01=ON)
	40	00/01	Noise reduction *(00=OFF, 01=ON)
	41	00/01	Auto notch function *(00=OFF, 01=ON)
	42	00/01	Repeater tone *(00=OFF, 01=ON)
	43	00/01	Tone squelch *(00=OFF, 01=ON)
	44	00/01	Speech compressor *(00=OFF, 01=ON)
	45	00/01	Monitor function *(00=OFF, 01=ON)
	46	00/01	VOX function *(00=OFF, 01=ON)
	47	00 to 02	BK-IN function *(00=BK-IN OFF, 01=Semi BK-IN ON, 02=Full BK-IN ON)
	48	00/01	Manual notch function *(00=OFF, 01=ON)

19 CONTROL COMMAND

Remote control (CI-V) information

◇ Command table

Cmd.	Sub cmd.	Data	Description		
16*	4F	00/01	Twin Peak Filter *(00=OFF, 01=ON) Can be turned ON only when Mark and Shift are set to 2125 Hz and 170 Hz, respectively.		
		50	Dial lock function *(00=OFF, 01=ON)		
		56	DSP filter type *(00=SHARP, 01=SOFT)		
		57	Manual notch width (00=WIDE, 01=MID, 02=NAR)		
		58	SSB transmit bandwidth (00=WIDE, 01=MID, 02=NAR)		
		65	Send the IP+ function setting (00=OFF, 01=ON)		
	66	00/01	Send/read the TX Inhibit function (00=OFF, 01=ON)		
17		p. 19-13	Send CW messages*2		
18	00		Turn OFF the transceiver		
	01		Turn ON the transceiver*3		
19	00		Read the transceiver ID		
1A*	00	p. 19-11	Send/read memory contents		
		p. 19-10	Send/read band stacking register contents		
		p. 19-12	Send/read memory keyer contents*1		
		00 to 49	Send/read the selected filter width (AM: 00=200 Hz to 49=10 kHz; other than AM modes: 00=50 Hz to 31/40=2700 Hz/3600 Hz)		
	04	00 to 13	Send/read the selected AGC time constant (00=OFF, AM: 01=0.3 sec. to 13=8.0 sec., SSB,CW,RTTY:01=0.1 sec. to 13=6.0 sec.)		
	05	00 01	p. 19-9	Send/read SSB RX HPF/LPF settings	
			00 02	00 to 10	Send/read SSB RX Tone (Bass) level (00=-5 to 10=+5)
		00 03	00 to 10	Send/read SSB RX Tone (Treble) level (00=-5 to 10=+5)	
		00 04	p. 19-9	Send/read AM RX HPF/LPF settings	
				00 05	00 to 10
		00 06	00 to 10		
		00 07	p. 19-9	Send/read FM RX HPF/LPF settings	
				00 08	00 to 10
		00 09	00 to 10		
		00 10	p. 19-9	Send/read CW RX HPF/LPF settings	
				00 11	p. 19-9
		00 12	00 to 10		
				00 13	00 to 10
		00 14	p. 19-9	Send/read SSB TX bandwidth for wide	
				00 15	p. 19-9
		00 16	p. 19-9		
				00 17	00 to 10
	00 18	00 to 10	Send/read AM TX Tone (Treble) level (00=-5 to 10=+5)		
	00 19	00 to 10	Send/read FM TX Tone (Bass) level (00=-5 to 10=+5)		
	00 20	00 to 10	Send/read FM TX Tone (Treble) level (00=-5 to 10=+5)		
00 21	00 00 to 02 55	Send/read beep gain (00 00=min. to 02 55=max.)			
00 22	00/01	Send/read beep gain limit *(00=OFF, 01=ON)			
00 23	00/01	Send/read confirmation beep (00=OFF, 01=ON)			
00 24	00	Send/read the band edge beep OFF			
		Send/read the band edge beep ON (Beep sounds with a default amateur band)			
		Send/read the band edge beep with user setting ON			
		Send/read the band edge beep with user setting/TX limit ON			
00 25	00 to 02	Send/read the RF/SQL Control setting (00=Auto, 01=SQL, 02=RF+SQL)			

Cmd.	Sub cmd.	Data	Description		
1A*	05	00 26	00 to 05	Send/read the TX Delay setting (HF) (00=OFF, 01=10 ms, 02=15 ms, 03=20 ms, 04=25 ms, 05=30 ms)	
			00 27	00 to 05	Send/read the TX Delay setting (50 MHz) (00=OFF, 01=10 ms, 02=15 ms, 03=20 ms, 04=25 ms, 05=30 ms)
		00 28	00 to 05	Send/read the TX Delay setting (70 MHz) (00=OFF, 01=10 ms, 02=15 ms, 03=20 ms, 04=25 ms, 05=30 ms)	
		00 29	00 to 05	Send/read the Time-Out Timer setting (00=OFF, 01=3 min., 02=5 min., 03=10min., 04=20 min., 05=30 min.)	
		00 30	00/01	Send/read quick split set *(00=OFF, 01=ON)	
				00 31	p. 19-10
		00 32	p. 19-10		
		00 33	00/01	Send/read split lock set *(00=OFF, 01=ON)	
				00 34	00/01
		00 35	00 or 01		
				00 36	00 to 02
		00 37	00 to 02		
				00 38	00/01
		00 39	00/01		
				00 40	00/01
		00 41	00/01		
				00 42	00/01
		00 43	00 00 to 02 55		
				00 44	00/01
		00 45	00/01		
				00 46	00/01
		00 47	00 to 02		
				00 48	00/01
		00 49	00 or 01		
				00 50	00 to 02
		00 51	00 to 02		
				00 52	00/01
		00 53	00/01		
				00 54	00/01
		00 55	00/01		
				00 56	00/01
		00 57	00/01		
				00 58	00 00 to 02 55
		00 59	00 or 01		
				00 60	00 00 to 02 55

19 CONTROL COMMAND

Remote control (CI-V) information

◇ Command table

Cmd.	Sub cmd.	Data	Description
1A*	05 00 61	00/01	Send/read squelch function for the AF signal output to ACC/USB (00=OFF (Open), 01=ON)
	00 62	00/01	Send/read beep and speech output setting to ACC/USB (when AF signal output is set) (00=OFF, 01=ON)
	00 63	00 00 to 02 55	Send/read IF signal output level to ACC/USB (00 00=0%, 02 55=100%)
	00 64	00 00 to 02 55	Send/read MOD input level from ACC (00 00=0% to 02 55=100%)
	00 65	00 00 to 02 55	Send/read MOD input level from USB (00 00=0% to 02 55=100%)
	00 66	00 to 04	Send/read MOD input connector during DATA OFF (00=MIC, 01=ACC, 02=MIC/ACC, 03=USB, 04=MIC/USB)
	00 67	00 to 04	Send/read MOD input connector during DATA (00=MIC, 01=ACC, 02=MIC/ACC, 03=USB, 04=MIC/USB)
	00 68	00/01	Send/read the external keypad setting for VOICE *(00=OFF, 01=ON)
	00 69	00/01	Send/read the external keypad setting for Memory KEYS (00=OFF, 01=ON)
	00 70	00/01	Send/read the external keypad setting for RTTY Memory (00=OFF, 01=ON)
	00 71	00/01	Send/read the CI-V transceiver setting (00=OFF, 01=ON)
	00 72	00 00 to 02 23	Send/read the transceiver CI-V Address for USB to REMOTE in hexadecimal code (00 00=00h to 02 23=DFh)
	00 73	00/01	Send/read the CI-V Output (for ANT) capability (00=OFF, 01=ON)
	00 74	00/01	Send/read the CI-V USB port setting (00=Link to [REMOTE], 01=Unlink to [REMOTE]) (Read only)
	00 75	00/01	Send/read echo back setting for CI-V operation from USB (00=ON, 01=OFF)
	00 76	00/01	Send/read the USB (serial port) function setting (00=CI-V, 01=RTTY Decode)
	00 77	00 to 03	Send/read data transfer speed for RTTY decode output (00=4800 bps, 01=9600 bps, 02=19200 bps, 03=38400 bps)
	00 78	00 to 02	Send/read transmission control line setting for USB (00=OFF, 01=DTR, 02=RTS) • Different line must be set from both CW keying and RTTY (FSK)
	00 79	00 to 02	Send/read CW keying line setting for USB (00=OFF, 01=DTR, 02=RTS) • Different line must be set from both transmission control and RTTY (FSK)
	00 80	00 to 02	Send/read RTTY (FSK) line setting for USB (00=OFF, 01=DTR, 02=RTS) • Different line must be set from both CW keying and transmission control"
	00 81	00 00 to 02 55	Send/read LCD unit backlight brightness (00 00=0% to 02 55=100%)
	00 82	00/01	Send/read screen image type (00=A, 01=B)
	00 83	00/01	Send/read frequency readout font (00=Basic, 01=Round)
	00 84	00/01	Send/read peak hold set for meter *(00=OFF, 01=ON)
	00 85	00/01	Send/read memory name indication setting (00=OFF, 01=ON)
	00 86	00/01	Send/read manual notch width pop-up indication setting (00=OFF, 01=ON)
	00 87	00/01	Send/read PBT shifting value display setting while rotating [TWIN PBT] (00=OFF, 01=ON)
	00 88	00/01	Send/read IF filter width and shifting value display setting when the IF filter is switched (00=OFF, 01=ON)

Cmd.	Sub cmd.	Data	Description
1A*	05 00 89	00 to 03	Send/read screen saver function (00=OFF, 01=15 minutes, 02=30 minutes, 03=60 minutes)
	00 90	00/01	Send/read opening message indication (00=OFF, 01=ON)
	00 91	p. 19-10	Send/read opening message contents (up to 10-character)
	00 92	00/01	Send/read Power ON Check setting (00=OFF, 01=ON)
	00 93	00/01	Send/read Display Language (00=English, 01=Japanese)
	00 94	20 00 01 01 to 20 99 12 31	Send/read date setting (20 00 01 01=2000/01/01 to 20 99 12 31=2099/12/31)
	00 95	00 00 to 23 59	Send/read time setting (00 00=00:00 to 23 59=23:59)
	00 96	p. 19-13	Send/read UTC offset time
	00 97	00/01	Send/read scope indication during TX (00=OFF, 01=ON)
	00 98	00 to 02	Send/read scope max. hold (00=OFF, 01=ON)
	00 99	00 to 02	Send/read scope center frequency set (00=Filter center, 01=Carrier point center, 02=Carrier point center (Abs. Freq.))
	01 00	00/01	Send/read scope marker position (FIX Type/ SCROLL Type) setting (00=Filter center, 01 Carrier point)
	01 01	00/01	Send/read external monitor signal width (00=Narrow, 01=Wide)
	01 02	00 to 03	Send/read averaging function for spectrum scope (00=OFF, 01=2, 02=3, 03=4)
	01 03	00/01	Send/read spectrum display type (00=Fill, 01=Fill+Line)
	01 04	p. 19-9	Send/read spectrum fill color
	01 05	p. 19-9	Send/read spectrum line color
	01 06	p. 19-9	Send/read spectrum color for peak hold
	01 07	00/01	Send/read waterfall set for spectrum scope (00=OFF, 01=ON)
	01 08	00 to 02	Send/read waterfall speed (00=Slow, 01=Mid, 02=Fast)
	01 09	00 to 02	Send/read waterfall height when expanded scope is selected (00=Small, 01=Mid, 02=Larger)
	01 10	00 to 07	Send/read peak color level set for waterfall of the spectrum scope (00=Grid 1, 01=Grid 2, 02=Grid 3, 03=Grid 4, 04=Grid 5, 05=Grid 6, 06=Grid 7, 07=Grid 8)
	01 11	00/01	Send/read scope waterfall marker auto-hide (00=OFF, 01=ON)
	01 12	p. 19-9	Send/read scope edge 1 frequencies for 0.03 to 1.60 MHz band
	01 13	p. 19-9	Send/read scope edge 2 frequencies for 0.03 to 1.60 MHz band
	01 14	p. 19-9	Send/read scope edge 3 frequencies for 0.03 to 1.60 MHz band
	01 15	p. 19-9	Send/read scope edge 1 frequencies for 1.60 to 2.00 MHz band
	01 16	p. 19-9	Send/read scope edge 2 frequencies for 1.60 to 2.00 MHz band
	01 17	p. 19-9	Send/read scope edge 3 frequencies for 1.60 to 2.00 MHz band
	01 18	p. 19-9	Send/read scope edge 1 frequencies for 2.00 to 6.00 MHz band
	01 19	p. 19-9	Send/read scope edge 2 frequencies for 2.00 to 6.00 MHz band
	01 20	p. 19-9	Send/read scope edge 3 frequencies for 2.00 to 6.00 MHz band
	01 21	p. 19-9	Send/read scope edge 1 frequencies for 6.00 to 8.00 MHz band
	01 22	p. 19-9	Send/read scope edge 2 frequencies for 6.00 to 8.00 MHz band
	01 23	p. 19-9	Send/read scope edge 3 frequencies for 6.00 to 8.00 MHz band

19 CONTROL COMMAND

Remote control (CI-V) information

◇ Command table

Cmd.	Sub cmd.	Data	Description
1A*	05	01 24	p. 19-9 Send/read scope edge 1 frequencies for 8.00 to 11.00 MHz band
		01 25	p. 19-9 Send/read scope edge 2 frequencies for 8.00 to 11.00 MHz band
		01 26	p. 19-9 Send/read scope edge 3 frequencies for 8.00 to 11.00 MHz band
		01 27	p. 19-9 Send/read scope edge 1 frequencies for 11.00 to 15.00 MHz band
		01 28	p. 19-9 Send/read scope edge 2 frequencies for 11.00 to 15.00 MHz band
		01 29	p. 19-9 Send/read scope edge 3 frequencies for 11.00 to 15.00 MHz band
		01 30	p. 19-9 Send/read scope edge 1 frequencies for 15.00 to 20.00 MHz band
		01 31	p. 19-9 Send/read scope edge 2 frequencies for 15.00 to 20.00 MHz band
		01 32	p. 19-9 Send/read scope edge 3 frequencies for 15.00 to 20.00 MHz band
		01 33	p. 19-9 Send/read scope edge 1 frequencies for 20.00 to 22.00 MHz band
		01 34	p. 19-9 Send/read scope edge 2 frequencies for 20.00 to 22.00 MHz band
		01 35	p. 19-9 Send/read scope edge 3 frequencies for 20.00 to 22.00 MHz band
		01 36	p. 19-9 Send/read scope edge 1 frequencies for 22.00 to 26.00 MHz band
		01 37	p. 19-9 Send/read scope edge 2 frequencies for 22.00 to 26.00 MHz band
		01 38	p. 19-9 Send/read scope edge 3 frequencies for 22.00 to 26.00 MHz band
		01 39	p. 19-9 Send/read scope edge 1 frequencies for 26.00 to 30.00 MHz band
		01 40	p. 19-9 Send/read scope edge 2 frequencies for 26.00 to 30.00 MHz band
		01 41	p. 19-9 Send/read scope edge 3 frequencies for 26.00 to 30.00 MHz band
		01 42	p. 19-9 Send/read scope edge 1 frequencies for 30.00 to 45.00 MHz band
		01 43	p. 19-9 Send/read scope edge 2 frequencies for 30.00 to 45.00 MHz band
		01 44	p. 19-9 Send/read scope edge 2 frequencies for 30.00 to 45.00 MHz band
		01 45	p. 19-9 Send/read scope edge 1 frequencies for 45.00 to 60.00 MHz band
		01 46	p. 19-9 Send/read scope edge 2 frequencies for 45.00 to 60.00 MHz band
		01 47	p. 19-9 Send/read scope edge 3 frequencies for 45.00 to 60.00 MHz band
		01 48	p. 19-9 Send/read scope edge 1 frequencies for 60.00 to 74.80 MHz band
		01 49	p. 19-9 Send/read scope edge 2 frequencies for 60.00 to 74.80 MHz band
		01 50	p. 19-9 Send/read scope edge 3 frequencies for 60.00 to 74.80 MHz band
		01 51	00/01 Send/read audio FFT scope display type (00=Fill, 01=Fill+Line)
		01 52	p. 19-9 Send/read the Audio FFT scope waveform color
		01 53	00/01 Send/read the Audio FFT scope waterfall display (00=OFF, 01=ON)
		01 54	p. 19-9 Send/read the Audio Oscilloscope scope waveform color
		01 55	00 Normal selection for contest number style 01 "190→ANO" selection for contest number style 02 "190→ANT" selection for contest number style 03 "90→NO" selection for contest number style 04 "90→NT" selection for contest number style
		01 56	01 to 08 Send/read count up trigger channel (01=M1, 02=M2, 03=M3, 04=M4, 05=M5, 06=M6, 07=M7, 08=M8)
		01 57	00 01 to 99 99 Send/read present number (00 01=1 to 99 99=9999)

Cmd.	Sub cmd.	Data	Description
1A*	05	01 58	00 00 to 02 55 Send/read CW side tone gain (00 00=0% to 02 55=100%)
		01 59	00/01 Send/read CW side tone gain limit (00=OFF, 01=ON)
		01 60	01 to 60 Send/read CW keyer repeat time (01=1 sec. to 60=60 sec.)
		01 61	28 to 45 Send/read CW keyer dot/dash ratio (28=1:1.2.8 to 45=1:1.4.5)
		01 62	00 to 03 Send/read rise time (00=2 msec., 01=4 msec., 02=6 msec., 03=8 msec.)
		01 63	00/01 Send/read paddle polarity (00=Normal, 01=Reverse)
		01 64	00 to 02 Send/read keyer type (00=Straight, 01=Bug, 02=Paddle)
		01 65	00/01 Send/read mic. up/down keyer set (00=OFF, 01=ON)
		01 66	00 to 03 Send/read averaging function for RTTY FFT scope (00=OFF, 01=2, 02=3, 03=4)
		01 67	p. 19-9 Send/read RTTY FFT scope waveform color
		01 68	00/01 Send/read RTTY decode USOS (00=OFF, 01=ON)
		01 69	00/01 Send/read RTTY decode new line code (00=CR,LF,CR+LF, 01=CR+LF)
		01 70	00/01 Send/read RTTY TX USOS (00=OFF, 01=ON)
		01 71	p. 19-9 Send/read received RTTY text font color
		01 72	p. 19-9 Send/read transmitted RTTY text font color
		01 73	00/01 Send/read RTTY log function (00=OFF, 01=ON)
		01 74	00/01 Send/read file saving format for the RTTY log (00=Text, 01=HTML)
		01 75	00/01 Send/read RTTY time stamp set (00=OFF, 01=ON)
		01 76	00/01 Send/read RTTY Decode Log Time Stamp (00=Local, 01=UTC)
		01 77	00/01 Send/read RTTY frequency stamp (00=OFF, 01=ON)
		01 78	00/01 Send/read scan speed (00=Low, 01=High)
		01 79	00/01 Send/read scan resume (00=OFF, 01=ON)
		01 80	00/01 Send/read auto monitor function setting when transmitting a recorded voice memory (00=OFF, 01=ON)
		01 81	01/15 Send/read repeat interval to transmit recorded voice audio (01=1 sec. to 15=15 sec.)
		01 82	00/01 Send/read recording mode for QSO recorder (00=TX&RX, 01=RX Only)
		01 83	00/01 Send/read recording TX audio for QSO recorder (00=Microphone audio, 01=TX monitor audio)
		01 84	00/01 Send/read squelch relation to recording RX audio for QSO recorder (00=Always, 01=Squelch Auto)
		01 85	00/01 Send/read QSO record file split function setting (00=OFF, 01=ON)
		01 86	00/01 Send/read PTT Automatic Recording function setting (00=OFF, 01=ON)
		01 87	00 to 03 Send/read RX audio recording status for PTT Automatic Recording function (00=OFF (records no RX audio), 01=Records the RX audio just before 5 sec., 02=Records the RX audio just before 10 sec., 03=Records the RX audio just before 15 sec.)
		01 88	00 to 03 Send/read QSO PLAY Skip time (00=3 sec., 01=5 sec., 02=10 sec., 03=30 sec.)
		01 89	00 to 09 Send/read NB depth (00=1 to 09=10)
		01 90	00 00 to 02 55 Send/read NB width (00 00=1 to 02 55=100)
		01 91	00 to 20 Send/read VOX delay (00=0.0 sec. to 20=2.0 sec.)
01 92	00 to 03 Send/read VOX voice delay (00=OFF, 01=Short, 02=Mid., 03=Long)		

19 CONTROL COMMAND

Remote control (CI-V) information

◇ Command table

Cmd.	Sub cmd.	Data	Description	
1A*	05	01 93	00/01	Send/read the MF band attenuator setting (00=OFF, 01=ON)
		01 94	00 to 02	Send/read on-screen keyboard layout (00=English, 01=German, 02=French)
		01 95	00 00 to 02 55	Send/read the Transmit voice level for the VOICE TX function (00 00=0% to 02 55=100%)
		01 96	p. 19-9	Send/read SSB-D TX bandwidth
		01 97	00/01	Inhibit Timer at USB connection (00=OFF, 01=ON)
		01 98	p. 19-12	Send/read the Front key customize [VOX/BK-IN] setting
		01 99	p. 19-12	Send/read the Front key customize [AUTOTUNE] setting
		02 00	p. 19-12	Send/read the Front key customize [▲] setting
		02 01	p. 19-12	Send/read the Front key customize [▼] setting
		02 02	p. 19-12	Send/read the MIC key customize [UP] setting
		02 03	p. 19-12	Send/read the MIC key customize [DOWN] setting
		02 04	p. 19-9	Send/read scope edge 4 frequencies for 0.03 - 1.60 MHz
		02 05	p. 19-9	Send/read scope edge 4 frequencies for 1.60 - 2.00 MHz
		02 06	p. 19-9	Send/read scope edge 4 frequencies for 2.00 - 6.00 MHz
		02 07	p. 19-9	Send/read scope edge 4 frequencies for 6.00 - 8.00 MHz
		02 08	p. 19-9	Send/read scope edge 4 frequencies for 8.00 - 11.00 MHz
		02 09	p. 19-9	Send/read scope edge 4 frequencies for 11.00 - 15.00 MHz
		02 10	p. 19-9	Send/read scope edge 4 frequencies for 15.00 - 20.00 MHz
		02 11	p. 19-9	Send/read scope edge 4 frequencies for 20.00 - 22.00 MHz
		02 12	p. 19-9	Send/read scope edge 4 frequencies for 22.00 - 26.00 MHz
		02 13	p. 19-9	Send/read scope edge 4 frequencies for 26.00 - 30.00 MHz
		02 14	p. 19-9	Send/read scope edge 4 frequencies for 30.00 - 45.00 MHz
		02 15	p. 19-9	Send/read scope edge 4 frequencies for 45.00 - 60.00 MHz
		02 16	p. 19-9	Send/read scope edge 4 frequencies for 60.00 - 74.80 MHz
		02 17	00/01	Send/read PTT Port Function setting 00=PTT Input 01=PTT Input + SEND Output
		06	p. 19-10	Send/read DATA mode setting
		07	00/01	Send/read IP+ function setting (00=OFF, 01=ON)
1B*	00	p. 19-13	Send/read repeater tone frequency	
	01	p. 19-13	Set/read TSQL tone frequency	

Cmd.	Sub cmd.	Data	Description	
1C	00*	00	Send/read transceiver's status RX • When CI-V Output (for ANT) (Command: 1C 04) is set to ON, automatically outputs when changed.	
		01	Send/read transceiver's status TX • When CI-V Output (for ANT) (Command: 1C 04) is set to ON, automatically outputs when changed.	
	01*	00 to 02	00=Send/read the antenna tuner OFF 01=Send/read the antenna tuner ON 02=Send/read to tuning	
		00/01	Send/read transmit frequency monitor setting (00=OFF, 01=ON)	
	03	p. 19-9	Read transmit frequency • When CI-V Output (for ANT) (Command: 1C 04) is set to ON, automatically outputs when changed.	
	04*	00/01	Send/read command to disable to output the antenna controller status frequency and so on from [REMOTE]	
			Send/read command to enable to output the antenna controller status frequency and so on from [REMOTE].	
	1E	00		Read number of available TX frequency band
		01	p. 19-9	Read TX band edge frequencies
		02		Read number of user-set TX frequency band
03*		p. 19-9	Send/read user-set TX band edge frequencies	
21*	00	p. 19-13	Send/read RIT frequency	
	01	00/01	Send/read RIT setting (00=OFF, 01=ON)	
	02	00/01	Send/read ΔTX setting (00=OFF, 01=ON)	
25*		p. 19-13	Send/read the selected or unselected VFO frequency	
26*		p. 19-13	Send/read the selected or unselected VFO's operating mode and filter	
27*	00	p. 19-14	Read the Scope waveform data • Only when "Scope ON/OFF status" (Command: 27 10) and "Scope data output" (Command: 27 11) are set to "ON," outputs the waveform data to the controller.	
			Send/read the Scope ON/OFF status (00=OFF, 01=ON)	
	10	00/01	Send/read the Scope wave data output*4 (00=OFF, 01=ON)	
	11	00/01	Send/read the Scope wave data output*4 (00=OFF, 01=ON)	
	12	00	Send/read the Main or Sub scope setting (00=Main only)	
	13	00	Send/read the Single/Dual scope setting (00=Single only)	
	14	p. 19-14	Send/read the Scope Center mode, Fixed mode, SCROLL-C mode, or SCROLL-F mode setting	
	15	p. 19-14	Send/read the Span setting in the Center mode or SCROLL-C mode Scope	
	16	p. 19-15	Send/read the Edge number setting in the Fixed mode or SCROLL-F mode Scope	
	17	p. 19-15	Send/read the Scope hold function ON or OFF	
19	p. 19-15	Send/read the Scope Reference level setting		
1A	p. 19-15	Send/read the Sweep speed setting		
1B	00/01	Send/read the Scope indication during TX in the Center mode (00=OFF, 01=ON)		

19 CONTROL COMMAND

Remote control (CI-V) information

◇ Command table

Cmd.	Sub cmd.	Data	Description
27*	1C	00 to 02	Send/read scope center frequency setting in the Center mode (00=Filter center, 01=Carrier point center, 02=Carrier point center (Abs. Freq.))
	1D	p. 19-15	Send/read the Scope VBW setting
	1E	p. 19-15	Send/read the Scope Fixed edge frequencies
	20	00/01	Send/read the Marker Position (FIX Type/SCROLL Type) setting (00=Filter Center, 01=Carrier Point)
28*	00	00 to 08	Transmits the Voice TX memory content (01=T1 to 08=T8, 0x00=Cancel TX)

* (Asterisk) Send/read data

*1 To insert a counter, first clear the other channel's counter.

*2 In the CW mode, if the [TRANSMIT] or an external TX switch is ON, or the Break-in function is ON, a message will be transmitted as CW code when you send it from your PC.

*3 When sending the power ON command (18 01), you need to repeatedly send "FE" before the standard format. The following is the approximated quantity of the repetition.

- 115200 bps: 150 "FE"s
- 57600 bps: 75 "FE"s
- 38400 bps: 50 "FE"s
- 19200 bps: 25 "FE"s
- 9600 bps: 13 "FE"s
- 4800 bps: 7 "FE"s

Example: When using 4800 bps

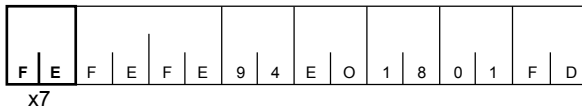

*4 You can only set this item when "Unlink from [REMOTE]" is selected on the "CI-V USB port" screen, and then "115200" is selected on the "CI-V Baud Rate" screen.

19 CONTROL COMMAND

Remote control (CI-V) information

◇ Data content description

• Operating frequency

Command: 00, 03, 05, 1C 03

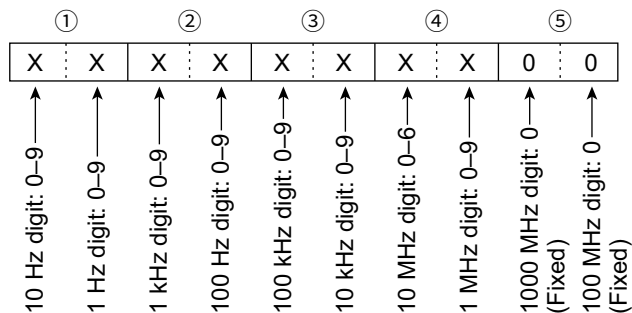

• Operating mode

Command: 01, 04, 06

Filter setting (②) can be skipped with command 01 and 06. In that case, "FIL1" is selected with command 01 and the default filter setting of the operating mode is automatically selected with command 06.

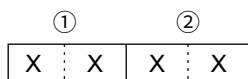

① Operating mode	② Filter setting
00: LSB	05: FM
01: USB	07: CW-R
02: AM	08: RTTY-R
03: CW	03: FIL3
04: RTTY	

• SSB/SSB-D transmission passband width settings

Command : 1A 05 00 14, 00 15, 00 16, 01 96

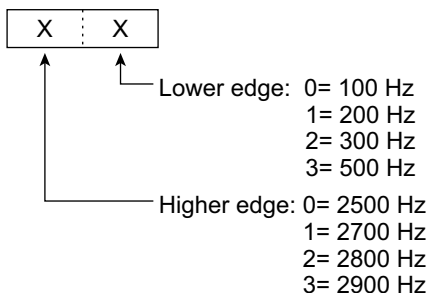

• RX HPF/LPF setting for each operating mode

Command : 1A 05 00 01, 00 04, 00 07, 00 10, 00 11

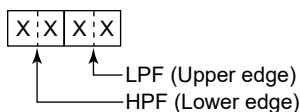

HPF	LPF
00: Through	05~24: 500~2400 Hz
01~20: 100~2000 Hz	25: Through

*The value of the HPF should be smaller than the LPF.

• Bandscope edge frequency settings

Command: 1A 05 01 12 ~ 01 50, 02 04 ~ 02 16

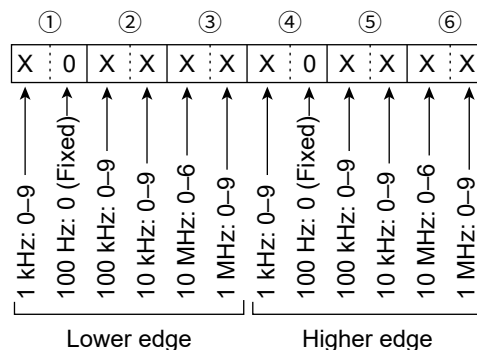

• Color settings

Command : 1A 05 01 04, 01 05, 01 06, 01 52, 01 54, 01 67, 01 71, 01 72

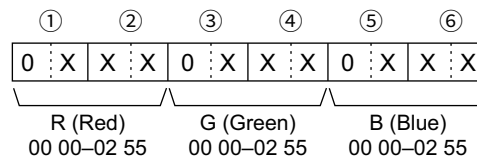

• Band edge frequency settings

Command : 02*, 1E 01, 1E 03

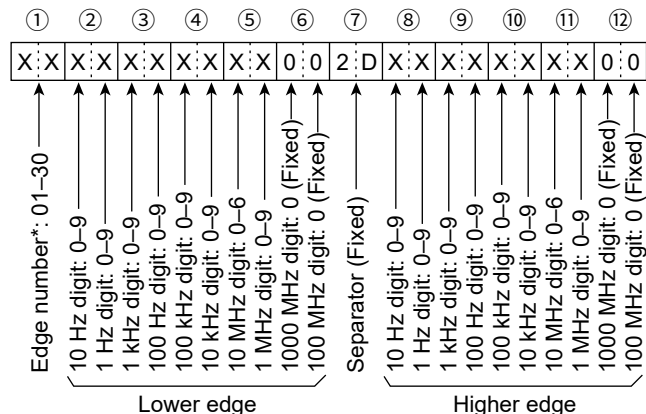

19 CONTROL COMMAND

Remote control (CI-V) information

• Band stacking register

Command: 1A 01

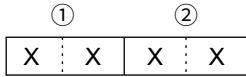

① Frequency band codes

Code	Freq. band	Frequency range (unit: MHz)
01	1.8	1.800000–1.999999
02	3.5	3.400000–4.099999
03	7	6.900000–7.499999
04	10	9.900000–10.499999
05	14	13.900000–14.499999
06	18	17.900000–18.499999
07	21	20.900000–21.499999
08	24	24.400000–25.099999
09	28	28.000000–29.999999
10	50	50.000000–54.000000
11	GENE	Other than above

② Register codes

Code	Registered number
01	1 (latest)
02	2
03	3 (oldest)

For example, when sending/reading the oldest contents in the 21 MHz band, the code “07 03” is used.

• Offset frequency settings

Command : 1A 05 00 31, 00 32

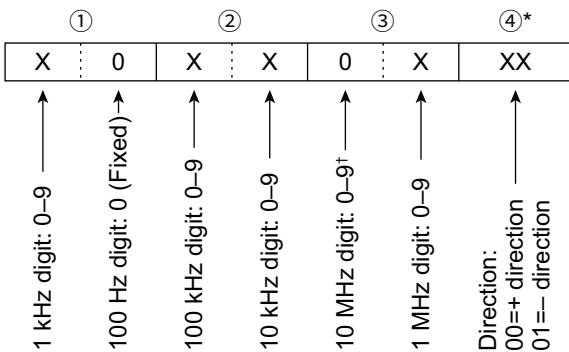

*1 There is no need to enter the transverter offset frequency setting.

*2 Transverter offset only. Fix to '0' for split offset setting.

• Codes for character entries

- Character codes— Letters and Numbers

Character	ASCII code	Character	ASCII code
A–Z	41–5A	a–z	61–7A
0–9	30–39		

- Character codes— Symbols

Character	ASCII code	Character	ASCII code
!	21	#	23
\$	24	%	25
&	26	\	5C
?	3F	”	22
,	27	`	60
^	5E	+	2B
–	2D	*	2A
/	2F	.	2E
,	2C	:	3A
;	3B	=	3D
<	3C	>	3E
(28)	29
[5B]	5D
{	7B	}	7D
	7C	_	5F
~	7E	@	40

Command	Set item/selectable characters
1A 00	Memory name All characters are usable.
05 00 91	Opening message Uppercase letters, numbers, symbols (- / . @) and space are usable.

• Data mode with filter width settings

Command : 1A 06

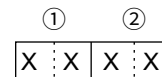

00=Data mode OFF*
01=Data mode ON

01=FIL1
02=FIL2
03=FIL3

*When 00 is set, also set 00 to ②

Remote control (CI-V) information

• Memory content

Command : 1A 00

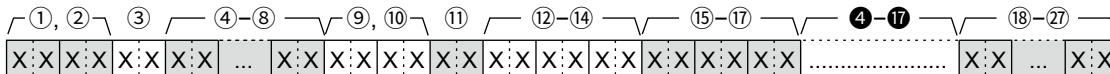

①, ② Memory channel numbers

00 01~00 99: Memory channel 01 to 99

01 00: Programmed scan edge P1

01 01: Programmed scan edge P2

③ Split and Select memory setting

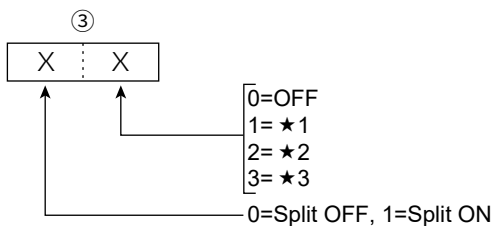

① Set both 0 for P1 and P2.

④~⑧ Operating frequency setting

See “• Operating frequency.”

⑨, ⑩ Operating mode setting

See “• Operating mode.”

⑪ Data mode and tone type settings

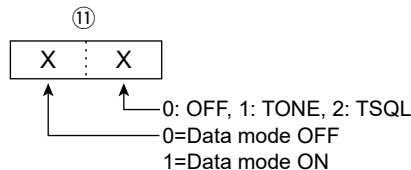

⑫~⑭ Repeater tone frequency setting

⑮~⑰ Tone squelch frequency setting

See “• Repeater tone/tone squelch settings.”

⑱~⑳ Memory name settings

Up to 10 characters.

See “• Codes for character entries”

To clear the memory channel contents on 1A 00:

①, ②: Memory channel (00 01~00 99)

③: “FF”

④: None

NOTE:

- The same data as ④~⑰ are stored in ④~⑰.
- When the Split function is ON, the data of ④~⑰ is used for transmit.
- Even if the Split function is OFF, enter the data into ④~⑰ to match your transceiver. We recommend that you set the same data as ④~⑰.

19 CONTROL COMMAND

Remote control (CI-V) information

• Memory keyer character entries

Command: 1A 02

- Character codes

Character	ASCII code	Description
0-9	30-39	Numbers
A-Z	41-5A	Letters
space	20	Word space
/	2F	Symbol
?	3F	Symbol
,	2C	Symbol
.	2E	Symbol
@	40	Symbol
^	5E	Example: to send B̄T, enter ^4254
*	2A	Inserts contest number (can be used for 1 channel only)

• Memory keyer content

Command: 1A 02

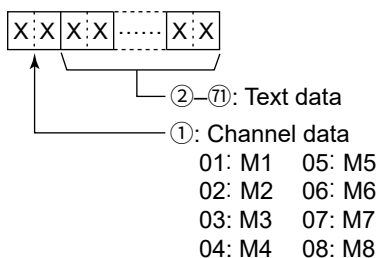

• [VOX/BK-IN] setting

Command: 1A 05 01 98

Data	Function
00	VOX/BK-IN
01	PRESET
02	Voice/Keyer/RTTY Memory 1
03	Voice/Keyer/RTTY Memory 2
04	Voice/Keyer/RTTY Memory 3
05	Voice/Keyer/RTTY Memory 4

• [AUTOTUNE] setting

Command: 1A 05 01 99

Data	Function
00	AUTOTUNE
01	PRESET
02	Voice/Keyer/RTTY Memory 1
03	Voice/Keyer/RTTY Memory 2
04	Voice/Keyer/RTTY Memory 3
05	Voice/Keyer/RTTY Memory 4

• [▲]/[▼] setting

Command: 1A 05 02 00, 02 01

Data	Function
00	M-CH UP
01	M-CH DOWN
02	PRESET
03	Voice/Keyer/RTTY Memory 1
04	Voice/Keyer/RTTY Memory 2
05	Voice/Keyer/RTTY Memory 3
06	Voice/Keyer/RTTY Memory 4

• MIC Key Customize setting

Command: 1A 05 02 02, 02 03

Data	Function
00	No function
01	UP
02	DOWN
03	UP (VFO: kHz)
04	DOWN (VFO: kHz)
05	XFC
06	VFO/MEMO
07	BAND UP
08	BAND DOWN
09	BAND DOWN
10	MODE
11	Voice/Keyer/RTTY Memory 1
12	Voice/Keyer/RTTY Memory 2
13	Voice/Keyer/RTTY Memory 3
14	Voice/Keyer/RTTY Memory 4
15	TS
16	MPAD
17	SPLIT
18	A/B
19	TUNER

19 CONTROL COMMAND

Remote control (CI-V) information

• Codes for CW message contents

Command : 17 Up to 30 characters

To send CW messages, use the following character codes.

Character	ASCII code	Character	ASCII code
0-9	30-39	'	27
A-Z	41-5A	(28
a-z	61-7A)	29
/	2F	=	3D
?	3F	+	2B
.	2E	"	22
-	2D	@	40
,	2C	Space	20
:	3A		

① "FF" stops sending CW messages.

① "^" is used to transmit a string of characters with no inter-character space.

• RIT frequency settings

Command : 21 00

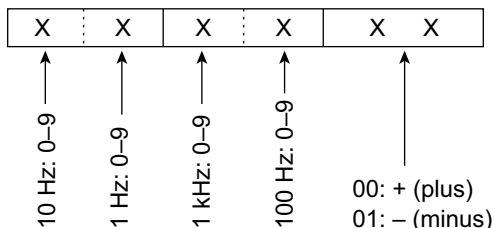

• Repeater tone/tone squelch frequency settings

Command : 1B 00, 1B 01

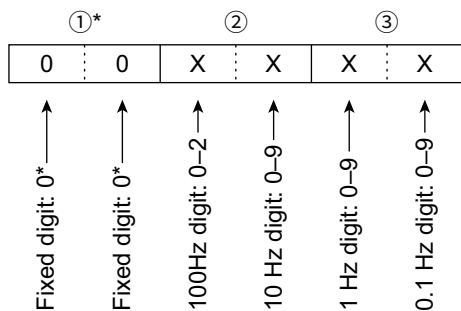

*Not necessary when setting a frequency.

• UTC Offset setting

Command : 1A 05 00 96

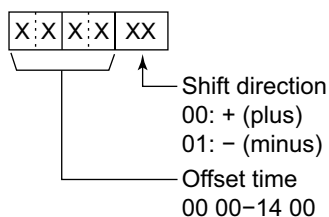

• Selected or unselected VFO frequency settings

Command: 25

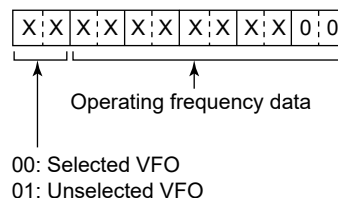

• Selected or unselected VFO's operating mode and filter settings

Command: 26

Both data and filter settings can be skipped. In that case, "DATA OFF" and the default filter setting of the operating mode are automatically selected.

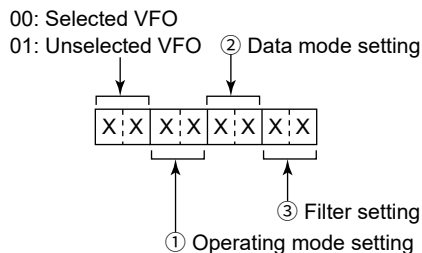

① Operating mode		② Data mode setting	③ Filter setting
00: LSB	05: FM	00: Data mode OFF	01: FIL1
01: USB	07: CW-R	01: Data mode ON	02: FIL2
02: AM	08: RTTY-R		03: FIL3
03: CW			
04: RTTY			

19 CONTROL COMMAND

Remote control (CI-V) information

• Scope waveform data

Command : 27 00

Outputs the waveform data to the controller

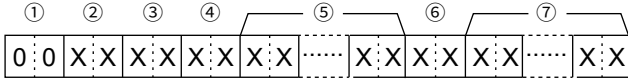

- ① 00 (Fixed)
- ② Order of division data (Current): 01~11
- ③ Division number (Maximum): 11 (USB)
 - ① When sent through the USB port, the data is divided by 11 and sent in sequential order.
 - ② The 1st data sends only the wave information (① ~ ⑥) without the waveform data (⑦). The 2nd or later data sends the minimum wave information (① ~ ③) with waveform data (⑦).

④ Spectrum scope mode data:

- 00 = Center mode scope
- 01 = Fixed mode scope
- 02 = SCROLL-C mode scope
- 03 = SCROLL-F mode scope

⑤ Waveform information

The waveform information is different between Center mode and fixed mode.

- In the Center mode:
 - Center frequency and span are sent.
 - See below for Frequency data, and the Scope span settings (② ~ ⑥) to the right.
- In the Fixed, SCROLL-C, and SCROLL-F modes:
 - Lower edge and higher edge frequencies are sent.

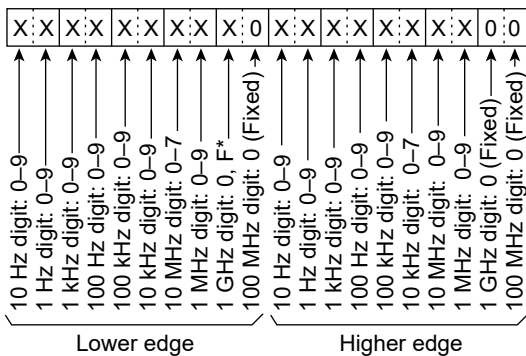

* "F" means that the Lower edge frequency is a negative value.

⑥ Out of range information

- 00 = In range
- 01 = Out of range

① If the scope data is out of range, the waveform data (⑦) is omitted.

⑦ Waveform data

The transceiver outputs the drawn waveform data. The data range or data length of the waveform data is judged by the controller. (The data range is basically the same as the display size of the scope on the controller.)

Data range	00 ~ A0 (0 ~ 160)
Data length	475

• Spectrum scope mode settings

Command: 27 14

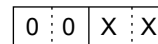

Fixed

- 00=Center mode
- 01=Fixed mode
- 02=SCROLL-C mode
- 03=SCROLL-F mode

• Scope span settings

(in the Center mode and SCROLL-C mode Scope)

Command : 27 15

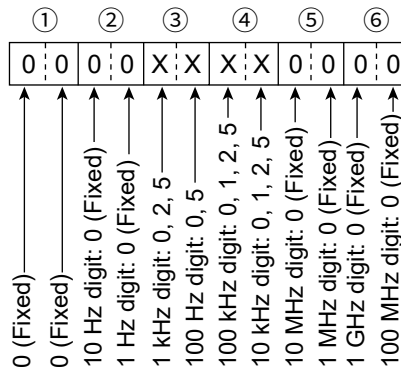

Span (kHz)	
2500	2.5
5000	5
10000	10
25000	25
50000	50
100000	100
250000	250
500000	500

Remote control (CI-V) information

• Scope Edge number settings

(in the Fixed mode and SCROLL-F mode Scope)

Command: 27 16

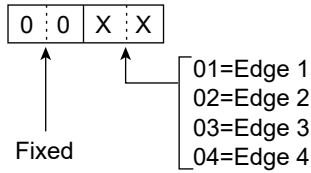

• Scope Hold settings

Command: 27 17

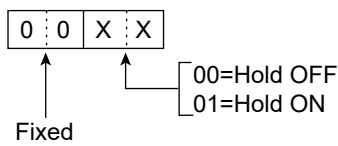

• Scope Reference level settings

Command : 27 19

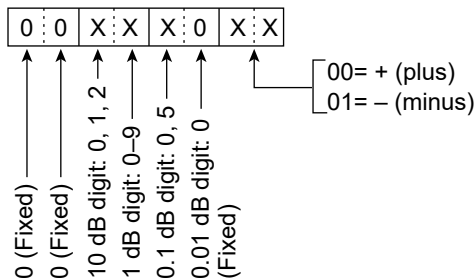

①Adjustable range: -20.0 dB ~ +20.0 dB in 0.5 dB steps

• Scope Sweep speed settings

Command : 27 1A

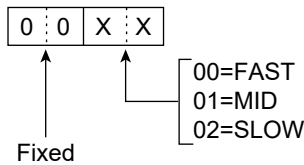

• Scope VBW (Video Band Width) settings

Command : 27 1D

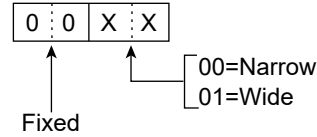

• Scope Fixed edge frequency settings

Command : 27 1E

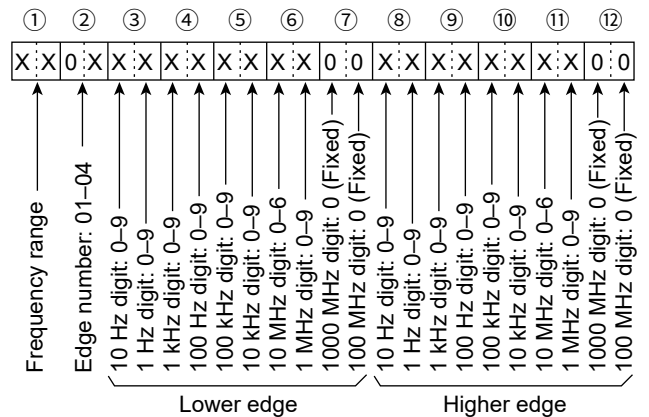

①Entry of digits less than 1 kHz is ignored.

① Selectable Frequency ranges

Data	Frequency range (Hz)
01	0.03 – 1.60
02	1.60 – 2.00
03	2.00 – 6.00
04	6.00 – 8.00
05	8.00 – 11.00
06	11.00 – 15.00
07	15.00 – 20.00
08	20.00 – 22.00
09	22.00 – 26.00
10	26.00 – 30.00
11	30.00 – 45.00
12	45.00 – 60.00
13	60.00 – 74.80

② Selectable Edge number: 01 = 1, 02 = 2, 03 = 3, 04 = 4

INDEX

Symbols and Numbers		C	
Δ F scan	10-6	Calibration Marker	12-9
Operation	10-6	Captured screen, viewing	13-5
Δ TX		Capturing a screen	13-5
Function	4-11	Center mode	5-3
Monitor function	4-11	Screen	5-2
1/4 Tuning function	3-5	CENTER Type Display	5-6
5 MHz frequency band operation (USA version only)	3-12	CI-V	
A		Address	12-10
ACC		Baud Rate	12-10
ACC AF Beep/Speech... Output	12-9	Command table	19-3
ACC AF Output Level	12-9	Connection	19-2
ACC AF SQL	12-9	Data format	19-2
ACC IF Output Level	12-9	Output (for ANT)	12-10
ACC Output Select	12-9	Preparing	19-2
MOD Level	12-9	Transceive	12-10
Socket, about	18-2	USB Baud Rate	12-11
Accessories, supplied	i	USB Echo Back	12-11
Adobe Acrobat Reader Installer	iii	USB Port	12-10
AGC		USB→REMOTE Transceive Address	12-10
Function control	4-4	Cleaning	14-2
time constant preset value, selecting	4-4	Clock	12-13
Time constant, setting	4-4	Connections	
AH-730, using	11-3	Front panel	2-2
AH-740, using	11-3	FSK and AFSK	2-5
ALC jack, about	18-4	Linear amplifier	2-6
All Reset	12-14, 14-4	Non-Icom linear amplifier	2-6
AM, tone control		Rear panel	2-3
RX audio High/Low pass filter setting	12-3	Connectors (Set mode)	12-9
RX Bass	12-3	Contest number menu (001 SET)	4-20
RX Treble	12-3	CW	
TX Bass	12-3	Auto Tuning function	4-16
TX Treble	12-3	Dot/Dash Ratio	4-21
Antenna tuner		Full Break-in mode	4-16
Connecting	2-4	Normal Side (LSB/USB)	12-6
External	11-3	Operating	4-14
Internal	11-2	Paddle Polarity	4-21
ANTI VOX	4-10	Pitch control, setting	4-14
Attenuator	4-3	Reverse mode	4-16
Audio scope		RX audio High/Low pass filter setting	12-3
Screen	5-9	Semi Break-in mode	4-15
Set screen	5-9	Side tone, monitoring	4-17
Auto		D	
Monitor (VOICE TX SET)	7-6	Data mode	
Notch function	4-9	(AFSK) operation	4-31
Tuning Step function	3-5	Selecting	3-3
Averaging (Scope set screen)	5-6	DATA MOD (Modulation signal)	12-10
B		DATA OFF MOD	12-10
Backlight	12-12	Date (Set mode)	12-13
Band Edge		DC power socket, about	18-4
Beep	3-6, 12-4	Decoder	
Deleting	3-8	New Line Code	4-28
Editing	3-7	Threshold level, setting	4-23
Entering	3-7	Decode USOS	4-28
Inserting	3-9	DELAY (VOX)	4-10
New entry	3-8	Deleting (Voice recorder)	
Resetting	3-9	All files	6-5
Band stacking registers	3-3	File	6-5
Basic manual	iii	Folder	6-6
Beep		DEPTH (Noise Blanker)	4-8
Confirmation	12-4	Dial Lock function	3-10
Level	12-4	Display	
Level Limit	12-4	Background, selecting	13-3
Break-in function	4-15	Font, selecting	13-3
Full	4-16	Font (Set mode)	12-12
Semi	4-15	Language	12-12
		Type (Background color)	12-12
		Type, selecting (Background color)	13-3

INDEX

E	
Emergency	
Mode ,tuner	11-4
Set mode	12-14
Entering and editing	1-9
Characters	1-9
Example	1-10
External DC power supply, connecting	2-4
EXT-SP jack	18-4
F	
FEATURES	i
FFT Scope	
Averaging	4-28
Waterfall Display	5-9
Waveform Color	4-28, 5-9
Waveform Type	5-9
File Type (RTTY decode log)	4-27
Fine Δ F scan	10-6
Operation	10-6
Fine Programmed scan	10-3
Operation	10-3
Fine Tuning function (1 Hz step)	3-4
Firmware update	15-2
Preparation	15-3
Set mode	12-13
Unzipping the firmware folder	15-4
Updating	15-5
Firmware version, checking	15-2
Fixed Edges	5-7
Fixed mode	5-3
Screen	5-2
FM	
Repeater operation	4-29
RX audio High/Low pass filter setting	12-3
RX Bass	12-3
RX Treble	12-3
SPLIT Offset (HF)	12-5
TX Bass	12-3
TX Treble	12-3
Font	
Color (Receive/Transmit characters)	4-28
Selecting	13-3
Format (SD Card)	12-13
Front panel	1-2
Full Break-in mode	4-16
FUNCTION screen	1-7
List	1-7
Function (Set mode)	12-4
Fuse	14-2
G	
Grounding	2-2
H	
HAM radio Terms	iii
Heat dissipation	2-2
I	
IC-PW2, connecting	2-6
IF filter	
Selecting	4-6
Shape, selecting	4-6
IP Plus function	4-7

K	
Key	
KEY jack, about	18-4
speed, setting	4-15
Type (Keyer set menu)	4-21
Key assignment	
Front panel	12-6
Microphone	12-6
Keyboard	
Characters	1-9
Entering and editing	1-9
Example	1-10
Full Keyboard Layout	1-9, 12-9
Types	1-9, 12-9
Keyer	
Function, electronic	4-17
Memory edit menu (EDIT)	4-19
Repeat time	4-21
Set menu (CW-KEY SET)	4-21
Keypad	
Connecting	18-3
Keypad KEYER	12-10
Keypad RTTY	12-10
Keypad VOICE	12-10
L	
LEVEL (Noise Blanker)	4-8
Load Setting (SD Card)	12-13
Lock Function, about	12-6
M	
Main dial	
Friction, adjusting	13-2
Using	3-4
MAIN DIAL Auto TS	12-6
Marker	5-3
Position (Fix Type)	5-6
MB-118, mounting	17-3
MB-123, attaching	17-3
Memo Pad	9-6
Calling up	9-6
List, using	9-6
Quantity	12-6
Saving the displayed contents	9-6
Memory	
Mode	3-2
Name, entering	9-5
Name (Set mode)	12-12
Operation	10-4
Scan	10-4
Screen	9-5
Memory channel	9-2
Clearing	9-4
Entering	3-6
Selecting	9-2
in the MEMORY screen	9-3
using the keypad	9-2
with the up and down keys	9-2
Memory channel contents	
Copying	9-4
to another memory channel	9-4
to the VFO	9-4
Entering	9-3
in the Memory mode	9-3
in the VFO mode	9-3
Memory keyer (KEYER)	4-18
MENU screen	1-7

INDEX

Meter display	3-11
Selection	3-11
Meter Peak Hold	12-12
MF Band ATT	12-4
MIC	
Up/Down Keyer	4-21
Up/Down Speed	12-6
Microphone	
Connector, about	18-3
Gain, adjusting	3-11
Mini scope screen	5-4
MODE SPEECH	12-5
Monitor function	4-11
Multi-function dial	1-8
Multi-function menu	1-8
Multi-function meter, selecting	3-11
My Call (Set mode)	12-12
My call sign, displaying	13-5
N	
Noise Blanker, about	4-8
Level and time, adjusting	4-8
Noise Reduction, about	4-9
Level, adjusting	4-9
Noise squelch	3-10
Notch function, about	4-9
Auto	4-9
Manual	4-9
Width menu display	12-12
[NOTCH] Switch	
AM	12-6
SSB	12-6
O	
Opening Message	12-12
Operating band, selecting	3-3
Operating frequency	
Entering	3-5
Setting	3-4
Operating mode, selecting	3-3
Options	17-2
Oscilloscope Waveform Color	5-9
Others (Set mode)	12-14
OVF	3-10
P	
P.AMP1/2	4-3
Partial Reset	12-14, 14-4
PHONES jack, about	18-4
PLAYER SET screen	6-9
Power	
ON Check	12-12
ON or OFF	3-2
When first applying	3-2
Preamplifiers	4-3
PRESET	13-6
Editing	13-6
Loading	13-6
Programmed scan	10-3
Protection function	13-4
Q	
QSO audio	
Playing back	6-3
Recording	6-2
QUICK MENU	1-7
Quick recording	6-2
Quick RIT/ Δ TX Clear	12-6
Quick Split function, using	4-13
Quick SPLIT (Set mode)	12-5
R	
Rear panel	1-4
RECORDER SET screen	6-8
Recording (Receive/transmit audio)	
Basic recording	6-2
Playing back	6-3
QSO audio	6-3
Recorded file on a PC	6-7
Voice TX memory	7-2
QSO audio	6-2
Quick recording	6-2
REF adjustment	13-4
REF Adjust (Set mode)	12-9
Remote control (CI-V) information	19-2
REMOTE jack, about	18-4
Repeater	
Input signal, checking	4-30
Tone frequency, checking	4-29
Tone frequency, setting	4-29
Resetting	14-4
All reset	14-4
Partial reset	14-4
RFG	3-10
RF gain	3-10
RF/SQL Control	12-4
Rise Time	4-21
RIT	
Function	4-3
Monitor function	4-3
RTTY	
Decode Baud Rate	12-11
Decode log set mode	4-27
DECODE screen, functions	4-23
Decode set mode	4-28
FSK, operating	4-22
Keying Polarity	12-5
Log contents	4-26
Log, turning ON	4-26
Mark Frequency	12-5
Memory content, transmitting	4-24
Memory, editing	4-25
Reverse mode	4-22
RX audio High/Low pass filter setting	12-3
Shift Width	12-5
S	
Save Setting (SD Card)	12-13
Scan	
Fine Δ F scan	10-6
Fine Programmed scan	10-3
Preparation	10-2
Resume	10-2
Set mode	10-2
Speed	10-2
Types	10-2
Screen Capture	
Capture function	13-5
Capture [POWER] SW	12-9
File Type	12-9
Viewing	12-13
Screen Saver	12-12
Scroll mode	5-3
Screen	5-2

INDEX

SD Card.....	8-2	SWR measurement	
Backing up the data saved onto a PC.....	8-8	Plot.....	13-3
Backup file on your PC.....	8-9	Spot.....	13-2
Deleting a data file.....	8-7	SWR, Multi-function meter.....	3-11
Folder contents.....	8-8		
Formatting.....	8-3	T	
Information.....	6-6, 8-7	Time-Out Timer (CI-V).....	12-5
Inserting.....	8-2	Time (Set mode).....	12-13
Loading the saved data files.....	8-6	Time Set (Set mode).....	12-13
Removing.....	8-2	Time Stamp	
Saving data.....	8-2	Frequency (RTTY decode log).....	4-27
Saving in the old firmware format.....	8-4, 12-13	RTTY decode log.....	4-27
Saving the setting data.....	8-4	Time (RTTY decode log).....	4-27
Saving with a different file name.....	8-5	Tone scan operation.....	10-7
Set mode.....	12-13	Tone squelch operation.....	4-30
Unmounting.....	8-3	Touch screen.....	iii, 1-5
Select Memory channel		Touch Screen Calibration.....	12-14
Setting.....	10-5	Function.....	14-3
Settings, cancelling all.....	10-5	Maintenance.....	iii
Select Memory scan.....	10-4	Operation (Spectrum scope).....	5-4
Operation.....	10-5	Precautions.....	iii
Semi Break-in mode.....	4-15	Transmission, basic.....	3-10
SEND jack, about.....	18-4	Transmit filter width, setting.....	4-14, 12-3
Set mode		Transmit output power, adjusting.....	3-10
Entering.....	12-2	Transmitter Lockout function.....	13-6
Item description.....	12-2	Troubleshooting.....	14-5
SHARP (IF filter shape).....	4-7	Tuner	
Side Tone		Connecting.....	2-4
Level.....	4-21	External.....	11-3
Level Limit.....	4-21	Internal.....	11-2
S-Level SPEECH.....	12-5	Preset Memory Clear.....	12-5
S-meter squelch.....	3-10	PTT Start.....	12-5
SOFT (IF filter shape).....	4-7	PTT Tuner start.....	11-2
Specifications.....	16-2	[TUNER] Switch.....	12-5
Spectrum Scope		Tuning	
During TX (CENTER TYPE).....	5-6	1/4.....	3-5
Max Hold.....	5-6	CW Auto.....	4-16
Reference level ,adjusting.....	5-5	Manual.....	11-2
Screen.....	5-2	PTT Tuner start.....	11-2
Set screen.....	5-6	Tuning Step	
Sweep speed.....	5-5	Auto.....	3-5
Using.....	5-2	Changing.....	3-4
Waterfall.....	5-7	Function.....	3-4
Waveform.....	5-7	Twin PBT	
SPEECH		IF filter width display.....	12-12
Function, using.....	13-2	PBT shift value.....	12-12
Language.....	12-5	Using.....	4-5
Level.....	12-6	Twin Peak Filter.....	4-22
Speed.....	12-5	TX Delay.....	12-5
Speech Compressor, setting.....	4-12	TX USOS.....	4-28
[SPEECH/LOCK] Switch.....	12-6		
Split Frequency		U	
Offset, entering.....	3-6	Unmount (SD Card).....	12-13
Operation.....	4-13	Updating the firmware.....	15-5
Split Lock function.....	4-14	USB	
SPLIT LOCK (Set mode).....	12-5	Baud Rate (CI-V).....	12-10
SQL level.....	3-10	Echo Back (CI-V).....	12-11
Squelch status.....	10-2	Inhibit Timer at USB Connection.....	12-11
SSB/CW Synchronous Tuning.....	12-6	Keying (CW).....	12-11
SSB-D, tone control, TBW.....	12-3	Keying (RTTY).....	12-11
SSB, tone control		MOD Level.....	12-9
RX audio Hi/Low filter.....	12-3	SEND.....	12-11
RX Bass.....	12-3	Serial Function.....	12-11
RX Treble.....	12-3	USB AF Beep/Speech... Output.....	12-9
TBW (MID).....	12-3	USB AF Output Level.....	12-9
TBW (NAR).....	12-3	USB AF SQL.....	12-9
TBW (WIDE).....	12-3	USB IF Output Level.....	12-9
TX Bass.....	12-3	USB Output Select.....	12-9
TX Treble.....	12-3	USB Port (CI-V).....	12-10
		USB→REMOTE Transceive Address.....	12-10

INDEX

UTC Offset.....12-13

V

VBW (Video Band Width)5-6

VFO

Mode3-2

Selecting.....3-2

Using3-2

VFO A and VFO B

Equalizing.....3-2

Receive and transmit frequencies4-13

Selecting.....3-2

VFO and Memory modes3-2

VOICE DELAY4-10

Voice memory contents

Name, entering.....7-3

Repeatedly transmitting.....7-4

Transmitting.....7-4

VOICE PLAYER screen.....6-4

Voice recorder

Deleting a file.....6-5

Deleting a folder6-6

File information, checking.....6-4

File Split function6-8

Folder information, checking6-5

Voice TX memory

Output level7-5

Recording7-2

Repeat Time7-6

VOICE TX SET screen7-6

Volume level, adjusting.....3-2

VOX

Adjusting.....4-10

ANTI4-10

Function.....4-10

GAIN.....4-10

Turning ON.....4-10

W

Waterfall (Spectrum Scope)

Display.....5-7

Marker Auto-hide5-7

Peak Color Level5-7

Size (Expand Screen)5-7

Speed.....5-7

Waveform (Spectrum Scope)

Color (Current)5-7

Color (Line).....5-7

Color (Max Hold)5-7

Type.....5-6

WIDTH (Noise Blanker)4-8

ABOUT CE

INSTALLATION NOTES

For amateur base station installations it is recommended that the forward clearance in front of the antenna array is calculated relative to the EIRP (Effective Isotropic Radiated Power). The clearance height below the antenna array can be determined in most cases from the RF power at the antenna input terminals.

As different exposure limits have been recommended for different frequencies, a relative table shows a guideline for installation considerations.

Below 30 MHz, the recommended limits are specified in terms of V/m or A/m fields as they are likely to fall within the near-field region. Similarly, the antennas may be physically short in terms of electrical length and that the installation will require some antenna matching device which can create local, high intensity magnetic fields. Analysis of such MF installations is best considered in association with published guidance notes such as the FCC OET Bulletin 65 Edition 97-01 and its annexes relative to amateur transmitter installations. The EC recommended limits are almost identical to the FCC specified 'uncontrolled' limits and tables exist that show pre-calculated safe distances for different antenna types for different frequency bands. Further information can be found at <http://www.arrl.org/>.

• Typical amateur radio installation

Exposure distance assumes that the predominant radiation pattern is forward and that radiation vertically downwards is at unity gain (sidelobe suppression is equal to main lobe gain). This is true of almost every gain antenna today. Exposed persons are assumed to be beneath the antenna array and have a typical height of 1.8 m.

The figures assume the worst case emission of a constant carrier.

For the bands 10 MHz and higher the following power density limits have been recommended:

10–50 MHz 2 W/sq m

Vertical clearance by EIRP output

1 Watts 2.1 m

10 Watts 2.8 m

25 Watts 3.4 m

100 Watts 5 m

1000 Watts 12 m

Forward clearance by EIRP output

100 Watts 2 m

1000 Watts 6.5 m

10,000 Watts 20 m

100,000 Watts 65 m

In all cases any possible risk depends on the transmitter being activated for long periods. (actual recommendation limits are specified as an average during 6 minutes) Normally the transmitter is not active for long periods of time. Some radio licenses will require that a timer circuit automatically cuts the transmitter after 1–2 minutes etc.

Similarly some types of emission, i.e., SSB, CW, AM etc. have a lower 'average' output power and the assessed risk is even lower.

