



INSTRUCTION MANUAL

MF/HF MARINE TRANSCEIVER  
**GM800**



Thank you for choosing this Icom product.  
 The GM800 MF/HF MARINE TRANSCEIVER is designed and built with Icom's state of the art technology and craftsmanship. With proper care, this product should provide you with years of trouble-free operation.

The GM800 has Class A DSC functions for Distress alert transmission and reception, as well as general DSC calls (Individual call, Group call Geographical call, Position Request call, Polling Request call, and Test call).

---

## IMPORTANT

---

**READ ALL INSTRUCTIONS** carefully and completely before using the transceiver.

**SAVE THIS INSTRUCTION MANUAL** — This instruction manual contains important operating instructions for the GM800.

**NOTE:** This transceiver receives the frequency range 30 kHz ~ 500 kHz in the J3E mode, but it has not been tested and Icom does not warrant the operation in this frequency range. Thus this transceiver does not conform to the permission of the frequency range 415 kHz ~ 526.5 kHz which is permitted by the ITU Radio Regulations [3].

**To stabilize the output frequency:**  
 ±10 Hz frequency stability requires a warming up time period.  
 The warming up time period is within 30 minutes after turning ON the transceiver's main power, and it differs depending on the output temperature.

Icom is not responsible for the destruction, damage to, or performance of any Icom or non-Icom equipment, if the malfunction is because of:

- Force majeure, including, but not limited to, fires, earthquakes, storms, floods, lightning, other natural disasters, disturbances, riots, war, or radioactive contamination.
- The use of Icom transceivers with any equipment that is not manufactured or approved by Icom.

Icom, Icom Inc. and the Icom logo are registered trademarks of Icom Incorporated (Japan) in Japan, the United States, the United Kingdom, Germany, France, Spain, Russia, Australia, New Zealand, and/or other countries.

---

## IN CASE OF EMERGENCY

---

When your ship requires assistance, contact other ships and the Coast Guard by sending a Distress call using DSC (digital selective calling) on an Emergency frequency.

**When immediate help is needed:**

1. To send a Distress call, hold down [DISTRESS] for 3 seconds until the short beeps become one long beep.
2. Release [DISTRESS] and wait for an acknowledgment.
3. After receiving the acknowledgement call, hold down [PTT] on the microphone and send the following information.
  - 1 "MAYDAY, MAYDAY, MAYDAY."
  - 2 "THIS IS . . . . . (name of ship)."
  - 3 "LOCATED AT . . . (ship's position)."
  - 4 Give the reason for the distress call.
  - 5 Explain what assistance you need.
  - 6 Give additional information about your ship:
    - Type
    - Length
    - Color
    - The number of people on board

---

## EXPLICIT DEFINITIONS

---

WORD	DEFINITION
⚠ <b>DANGER!</b>	Personal death, serious injury or an explosion may occur.
⚠ <b>WARNING!</b>	Personal injury, fire hazard or electric shock may occur.
<b>CAUTION</b>	Equipment damage may occur.
<b>NOTE</b>	If disregarded, inconvenience only. No risk of personal injury, fire or electric shock.

---

## PRECAUTIONS

---

**⚠ DANGER HIGH RF VOLTAGE! NEVER** touch an antenna while transmitting. This may result in an electrical shock or burn.

**⚠ WARNING! NEVER** operate the transceiver during a lightning storm. It may result in an electric shock, cause a fire or damage the transceiver. Always disconnect the power source and antenna before a storm.

**⚠ WARNING! NEVER** directly connect the transceiver to an AC outlet. This may pose a fire hazard or result in an electric shock.

**⚠ WARNING! NEVER** mount the transceiver main unit overhead. The weight of the unit is approximately 8.5 kg, and it could easily fall due to wave shocks or vibration. The unit must be mounted on a flat hard surface only.

**⚠ WARNING! NEVER** connect a power source of more than 31.2 V DC. This connection could cause a fire or ruin the transceiver.

**⚠ WARNING! NEVER** place the transceiver where normal operation of the ship may be hindered, or where it could cause bodily injury.

**⚠ WARNING! NEVER** let metal, wire or other objects protrude into the transceiver or into connectors on the rear panel. This may result in an electric shock.

**CAUTION: DO NOT** use harsh solvents such as benzene or alcohol when cleaning, because they will damage the transceiver's surfaces.

**CAUTION: DO NOT** use the transceiver in areas with temperatures below  $-15^{\circ}\text{C}$  or above  $+55^{\circ}\text{C}$ .

**CAUTION: DO NOT** place the transceiver in excessively dusty environments or in direct sunlight.

**CAUTION: DO NOT** use non-Icom handsets or microphones. Other manufacturer's handset or microphones have different pin assignments, and connection to the GM800 may damage the transceiver.

**CAUTION: DO NOT** place the transceiver against walls or putting anything on top of the transceiver. This may overheat the transceiver.

**BE CAREFUL!** The transceiver main unit will become hot when operating the transceiver continuously for long periods of time.

**BE CAREFUL!** The remote controller's front panel meets IPX7\* requirements for waterproof protection. However, once the transceiver has been dropped, or the waterproof seal is cracked or damaged, waterproof protection cannot be guaranteed because of possible damage to the case or the waterproof seal.

\* The connectors on the rear panel do not meet IPX7.

**NOTE:** The LCD display may have cosmetic imperfections that appear as small dark or light spots. This is not a malfunction or defect, but a normal characteristic of LCD displays.

**NOTE:** Install the transceiver and handset or microphone as far away as possible, (at least 1 meter), from the magnetic navigation compass, to prevent erroneous indications.

**NOTE:** Always place unit in a secure place to avoid inadvertent use by unauthorized persons.

---

## RECOMMENDATION

---

**CLEAN THE REMOTE CONTROLLER'S FRONT PANEL THOROUGHLY IN A BOWL OF FRESH WATER** after exposure to saltwater, and dry it before operating. Otherwise, the remote controller's keys, switches may become unusable, due to salt crystallization.

① The connectors on the rear panel do not meet IPX7.

**NOTE:** If the remote controller's waterproof protection appears defective, carefully clean it with a soft, damp (fresh water) cloth, then dry it before operating. The remote controller may lose its waterproof protection if the case, or connector cover is cracked or broken, or the remote controller has been dropped. Contact your Icom distributor or your dealer for advice.

---

## INSTALLATION NOTE

---

### Installation:

The installation of this equipment should be made in such a manner as to respect the EC recommended electromagnetic field exposure limits. (1999/519/EC)

The maximum RF power available from this device is 150 watts. The antenna should be installed as high as possible for maximum efficiency and the installation height should be at least 2.0 meters above any accessible position. In the case where an antenna cannot be installed at a reasonable height, then the transmitter should neither be continuously operated for long periods if any person is within a distance of 2.0 meters of the antenna, nor operated at all if any person is touching the antenna.

It is recommended that antenna of a maximum gain of 0 dBd is used. If higher gain antenna are required then please contact your Icom distributor for revised installation recommendations.

### Operation:

The exposure to RF electromagnetic field is only applicable when this device is transmitting. This exposure is naturally reduced due to the nature of alternating periods of receiving and transmitting. Keep your transmissions to the minimum necessary.

---

## DISPOSAL

---



The crossed-out wheeled-bin symbol on your product, literature, or packaging reminds you that in the European Union, all electrical and electronic products, batteries, and accumulators (rechargeable batteries) must be taken to designated collection locations at the end of their working life. Do not dispose of these products as unsorted municipal waste. Dispose of them according to the laws in your area.

# TABLE OF CONTENTS

<b>1. OPERATING RULES .....1</b>		
<b>2. PANEL DESCRIPTION .....2-7</b>		
■ Main unit ..... 2		
■ Remote Controller front panel ..... 3		
■ Handset..... 4		
◇ About the Speaker Switch ..... 4		
■ Optional HM-214H ..... 4		
■ Software Key function ..... 4		
◇ Selecting the Software Key function..... 4		
◇ Functions..... 5		
■ Function display (Main screen)..... 6		
◇ Status area ..... 6		
◇ Information area ..... 6		
◇ Channel and Frequency area..... 6		
◇ Task area..... 6		
◇ Position Date and Time area ..... 7		
<b>3. PREPARATION.....8</b>		
■ Entering the MMSI code ..... 8		
<b>4. MENU SCREEN.....9-10</b>		
■ Menu Construction..... 9		
■ Selecting the item ..... 10		
<b>5. BASIC OPERATION ..... 11-12</b>		
■ Selecting a Channel or Group..... 11		
◇ Using the channel and group selector..... 11		
◇ Using the keypad..... 11		
■ Receiving and transmitting..... 12		
◇ Receiving..... 12		
◇ Transmitting..... 12		
■ DSC scan..... 12		
<b>6. OTHER FUNCTIONS AND OPERATIONS..... 13-22</b>		
■ Backlight function..... 13		
■ Scan..... 14		
◇ Channel scan and Channel Resume scan ..... 14		
◇ Programmed scan ..... 14		
■ Other functions..... 15		
◇ Transmit Frequency Monitor function..... 15		
◇ Squelch function..... 15		
◇ S-meter squelch level..... 15		
◇ Noise Blanker function ..... 15		
◇ Noise blanker level ..... 15		
◇ Automatic Gain Control OFF ..... 16		
◇ RF gain level ..... 16		
◇ Clarity Control function ..... 16		
◇ Automatic Antenna Tuner function.. 16		
■ Setting a temporary operating frequency ..... 17		
■ Setting a User channel or an ITU Simplex channel..... 18		
■ Assigning a function..... 20		
◇ Assigning a Software Key function to a Software Key ..... 20		
◇ Assigning a Software Key function to [VOL] ..... 21		
◇ Assigning a Software Key function to [P] on the HM-214H MICROPHONE..... 22		
<b>7. DSC OPERATION.....23-74</b>		
■ DSC address ID ..... 23		
◇ Entering an Individual ID ..... 23		
◇ Entering a Group ID ..... 25		
◇ Deleting an entered ID ..... 26		
■ Entering position data and time ..... 27		
■ DSC Task mode..... 29		
◇ About "Active" and "Hold" ..... 29		
◇ Software Key functions..... 29		
■ Sending a Distress call ..... 30		
◇ Simple call ..... 30		
◇ Regular call ..... 31		
◇ Resending a Distress call..... 33		
◇ Sending a Distress Cancel call.. 34		
◇ Sending a Distress acknowledgement ..... 36		
◇ Sending a Distress Relay call.... 37		
◇ Sending a Distress Relay acknowledgement ..... 42		
■ Sending a Non-Distress calls..... 43		
◇ Sending an Individual call..... 43		
◇ Sending an Individual acknowledgement ..... 45		
◇ Sending a Group call..... 45		
◇ Sending a Geographical call ..... 47		
◇ Sending a Position Request call 50		
◇ Sending a Position Request acknowledgement ..... 51		
◇ Sending a Polling Request acknowledgement ..... 52		
◇ Sending a Test call ..... 52		
◇ Sending a Test call acknowledgement ..... 53		
◇ Sending a Medical Transports call or Ships and Aircraft call..... 54		
■ Receiving DSC calls ..... 57		
◇ Receiving a Distress Call ..... 57		
◇ Receiving a Distress acknowledgement ..... 58		
◇ Receiving a Distress Cancel call59		
◇ Receiving a Distress Relay call . 59		
◇ Receiving a Distress Relay acknowledgement ..... 60		
◇ Receiving an Individual call ..... 61		
◇ Receiving an Individual acknowledgement ..... 61		
◇ Receiving a Group call ..... 63		
◇ Receiving a Geographical Area call ..... 64		
◇ Receiving a Position Request Call.. 65		
◇ Receiving a Position Request acknowledgement ..... 65		
◇ Receiving a Polling Request call66		
◇ Receiving a Test call..... 66		
◇ Receiving a Test acknowledgement ..... 67		
◇ Receiving a Medical Transports call67		
◇ Receiving a Ships and Aircraft call . 68		
■ Received Call log ..... 69		
◇ Distress message..... 69		
◇ Other messages ..... 69		
■ Transmitted Call log ..... 69		
■ DSC Settings ..... 70		
◇ DSC Frequency ..... 70		
◇ Automatic acknowledgement .... 71		
◇ Setting the "Medical Transports" item display option..... 72		
◇ Setting the "Ships and Aircraft" item display option..... 72		
◇ Distress Scanning Receiver ..... 72		
◇ Setting the 10 Second Delay..... 73		
◇ Setting the Alarm Status ..... 73		
◇ Auto Print..... 74		
◇ DSC Loop Test ..... 74		
<b>8. MENU ITEMS.....75-77</b>		
■ Menu items ..... 75		
■ Radio Settings..... 75		
■ Configuration..... 76		
<b>9. CONNECTIONS AND INSTALLATION.....78-86</b>		
■ Supplied accessories ..... 78		
■ Basic connections ..... 78		
■ Advanced connections ..... 79		
■ Ground connection..... 80		
■ Software maintenance ..... 80		
■ Power source ..... 81		
■ Antenna..... 81		
■ Mounting ..... 82		
◇ Mounting location ..... 82		
◇ Attaching the mounting plates .. 82		
◇ Mounting the remote controller . 82		
◇ Mounting the main unit..... 82		
■ Using the optional MB-108..... 83		
■ Replacing fuses ..... 84		
■ Connector information..... 85		
■ Transceiver dimensions ..... 86		
<b>10. SPECIFICATIONS AND OPTIONS .....87-88</b>		
<b>11. TROUBLESHOOTING.....89</b>		
<b>12. DIGITAL INTERFACE (IEC 61162-1).....90-93</b>		
■ I/O Sentences ..... 90		
◇ Version number ..... 90		
◇ GPS Input sentences (IEC 61162-1) ..... 90		
◇ GPS Input sentence description 90		
◇ Remote Input and Outputsentences (IEC 61162-1)..... 91		
◇ Remote sentence description.... 91		
■ Schematic diagram ..... 92		
■ Hardware version..... 93		
■ Software version ..... 93		
<b>INDEX.....94</b>		

**NOTE:** Before transmitting, monitor the channel you want to use to avoid interrupting communications already in progress.

**• CALL PROCEDURE**

Calls must be properly identified and the time limit must be respected.

1. Give your call sign each time you call another ship or coast guard station. If you have no call sign, identify the station by giving your ship name and the name of the licensee.
2. Give your call sign at the end of each transmission that lasts more than 3 minutes.
3. You must break and give your call sign at least once every 15 minutes during long ship-to-shore calls.
4. Keep your unanswered calls short, less than 30 seconds. Do not repeat a call for 2 minutes.
5. Unnecessary transmissions are not allowed.

**• PRIORITIES**

1. Read all rules and regulations pertaining to priorities and keep an up-to-date copy handy. Safety and Distress calls take priority over any other calls.
2. False or fraudulent Distress signals are prohibited and punishable by law.

**• PRIVACY**

1. Information overheard but not intended for you, cannot lawfully be used in any case.
2. Indecent or profane language is prohibited.

**• LOGS**

1. All Distress, Emergency and Safety calls must be recorded in complete details. Log data activity is usually recorded for 24 hours. Universal Time Coordinated (UTC) is frequently used.
2. Keep adjustments, repairs, channel frequency changes and authorized modifications affecting electrical operation of the equipment in the maintenance log. The entries requires signatures by the authorized licensed technician performing or supervising the work.

**• RADIO LICENSES****(1) SHIP RADIO STATION LICENSE**

You need a current ship radio station license before using the transceiver. It is unlawful to operate a ship radio station which is not licensed, but required to be.

If required, contact your dealer or the appropriate government agency for a Ship-Radiotelephone license application. This government-issued license states the call sign which is your craft's identification for radio communication purposes.

**(2) OPERATOR'S LICENSE**

A Restricted Radiotelephone Operator Permit is the license most often held by small vessel radio operators when a radio is not required for safety purposes.

If required, the Restricted Radiotelephone Operator Permit must be posted or kept with the operator. If required, only a licensed radio operator may operate a transceiver.

However, non-licensed individuals may talk over a transceiver if a licensed operator starts, supervises, ends the call and makes the necessary log entries.

A current copy of the applicable government rules and regulations is only required to be on hand for vessels in which a radio telephone is compulsory. However, even if you are not required to have these on hand it is your responsibility to be thoroughly acquainted with all pertinent rules and regulations.

## ■ Main unit

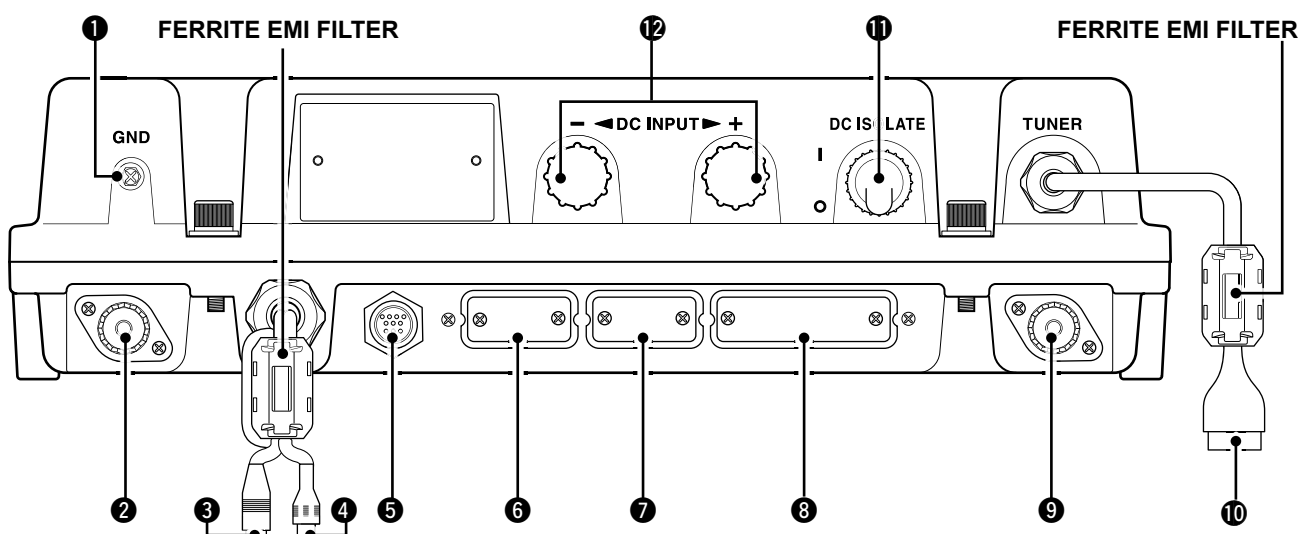

### 1 GROUND TERMINAL [GND]

Connect to the ship's ground. (p. 81)

### 2 DSC ANTENNA CONNECTER

Connect to a 50 Ω HF marine band antenna through a 50 Ω coaxial cable with a PL-259 plug. This antenna is used for receiving Distress calls.

**NOTE:** To receive a Distress call, **BE SURE** to connect an HF marine band antenna to this antenna connector. Otherwise, you cannot receive any Distress calls.

### 3 SPEAKER JACK [SP]

Connect to the SP-24 (p. 80) or an external speaker.

**NOTE:** When using an external speaker, **BE SURE** to turn OFF the internal speaker. (p. 5) Audio is output from the external speaker only when the internal speaker is OFF.

### 4 GPS JACK [GPS]

Connect to a GPS receiver to input position and UTC data for DSC operations. (IEC 61162-1 Edition 4.0 (2010-11))

- An IEC 61162-1 Edition 4.0 (2010-11) (sentence formatters: GGA) compatible GPS receiver is required. Ask your dealer about suitable GPS receivers.

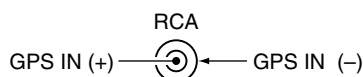

### 5 CONTROLLER CONNECTOR [CONTROLLER]

Connect to the supplied controller.

### 6 MODEM SOCKET [AF/MOD] (p. 87)

Connect to an external terminal unit for SSB mode operation through an RS-232C cable (D-sub 15-pin).

### 7 REMOTE SOCKET [REMOTE] (p. 88)

Connect to a PC through an RS-232C cable (D-sub 9-pin) for remote control.

### 8 PRINTER CONNECTOR

Connect to an IBM® centronics or compatible printer to automatically or manually print out received DSC information.

### 9 ANTENNA CONNECTOR

Connect to a wire or whip antenna through the AT-141 HF AUTOMATIC ANTENNA TUNER. The antenna is used for transmitting any calls and receiving any calls other than Distress calls.

⚠ **WARNING!** NEVER directly connect the antenna to this connector.

### 10 TUNER CONTROL SOCKET [TUNE]

Connect to the control cable of the supplied AT-141 HF AUTOMATIC ANTENNA TUNER. A female connector kit is supplied to connect the AT-141.

### 11 POWER SWITCH [DC ISOLATE]

Turns the transceiver's main power ON or OFF. When the main power is ON, the power key's backlight is dimly lit.

### 12 DC POWER TERMINALS

Connect to a 24 V DC power source through the supplied DC power cables. The red terminal is positive (+) and the black terminal is negative (-).

## Remote Controller front panel

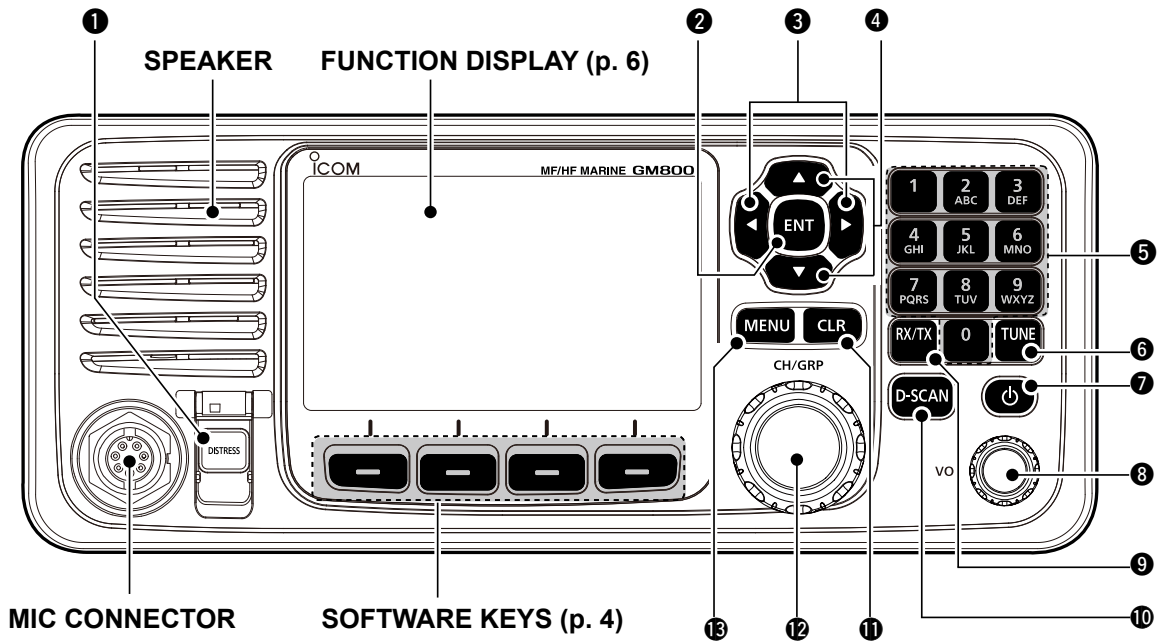

- 1 DISTRESS KEY [DISTRESS]**  
Hold down for 3 seconds to transmit a Distress call. (p. 30)
- 2 ENTER KEY [ENT]**  
Push to set the entered data, selected item, and so on.
- 3 LEFT AND RIGHT KEYS [◀]/[▶]**
  - Push to scroll the Software Key functions. (p. 4)
  - In the Character or Number Entry mode, push to select a character or number in the table.
- 4 UP AND DOWN KEYS [▲]/[▼]**  
Push to select an operating channel, menu items, menu settings, and so on.
- 5 KEYPAD**  
Push to enter numbers, letters or symbols.
- 6 TUNE KEY [TUNE]**
  - Push to turn ON the Automatic Antenna Tuner function, or to go through (bypass) the tuning circuit. (p. 16)
  - Hold down to start manual tuning.
    - ① After tuning is completed, "TUNE" is displayed.
    - ① When the tuner cannot tune the antenna, "THRU" is displayed.
- 7 POWER KEY [⏻]**  
Hold down for 1 second to turn the transceiver ON or OFF.

- 8 VOLUME DIAL [VOL]**
  - Rotate to adjust the speaker volume level.
  - Push 1 ~ 5 times to display the setting screens.

Pushing once	The Volume Setting window is displayed.
Pushing twice	The NB Level Setting window is displayed.
Pushing 3 times	The S-SQL Level Setting window is displayed.
Pushing 4 times	The RF Gain Setting window is displayed.
Pushing 5 times	The Backlight Settings window is displayed.

- 9 RX/TX KEY [RX/TX]**  
Push to set a temporary operating frequency. (p. 17)
- 10 DSC SCAN KEY [D-SCAN]**  
Push to start a DSC scan. (p. 12)
- 11 CLEAR KEY [CLR]**  
Push to cancel the entered data, or to return to the previous screen.
- 12 CHANNEL/GROUP SELECTOR [CH/GRP]**
  - Push to select the Channel Select mode or the Group Select mode. (p. 11)
  - Push to set the entered data, selected item, and so on.
  - Rotate to select the operating channel, menu items, menu settings, and so on.
- 13 MENU KEY [MENU]**  
Push to enter or exit the Menu screen.



## ■ Handset

### ◇ About the Speaker Switch

**When the switch is set to the “” position:**  
You can hear the receive audio from the remote controller's speaker.

**When the switch is set to the “” position:**  
Mutes the remote controller speaker output.  
• You can hear the receive audio from the handset.

Put the handset into the cradle to output the hear audio from the remote controller's speaker.

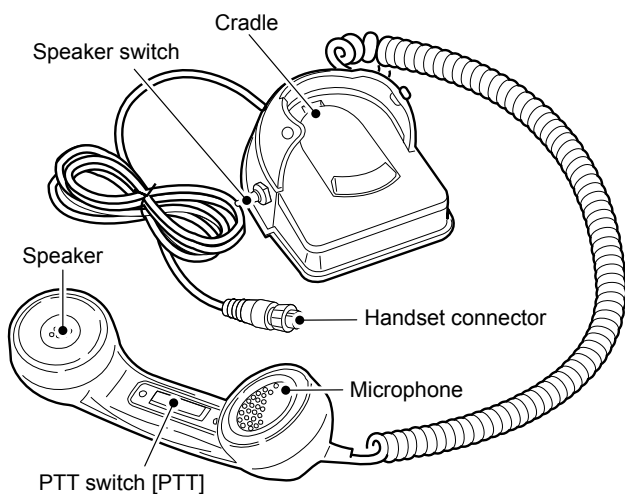

## ■ Optional HM-214H

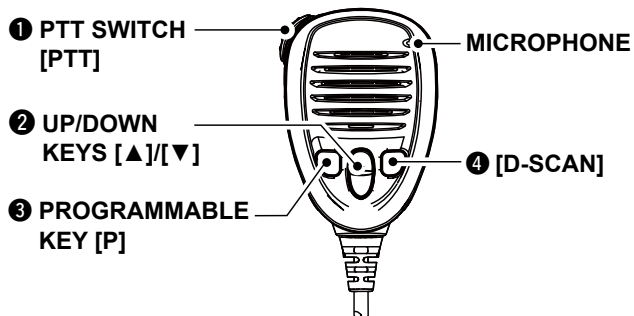

- ❶ **PTT SWITCH [PTT]**  
Hold down to transmit, release to receive.
- ❷ **UP/DOWN KEYS [▲]/[▼]**  
Push to select an operating channel or group.
- ❸ **PROGRAMMABLE KEY [P]**  
Push to activate the preset Software Key function. Ask your dealer for details. You can reassign some Software Key functions to the key. (p. 20)
- ❹ **DSC SCAN KEY [D-SCAN]**  
Push to start the DSC scan. (p. 12)

## ■ Software Key function

The transceiver has Software Keys for various functions. The key's function is displayed above them, as shown below.

### ◇ Selecting the Software Key function

When “◀” or “▶” is displayed beside the key icon, pushing [◀] or [▶] scrolls the Software Key functions. When you push [◀] or [▶] once, 4 functions scroll together.

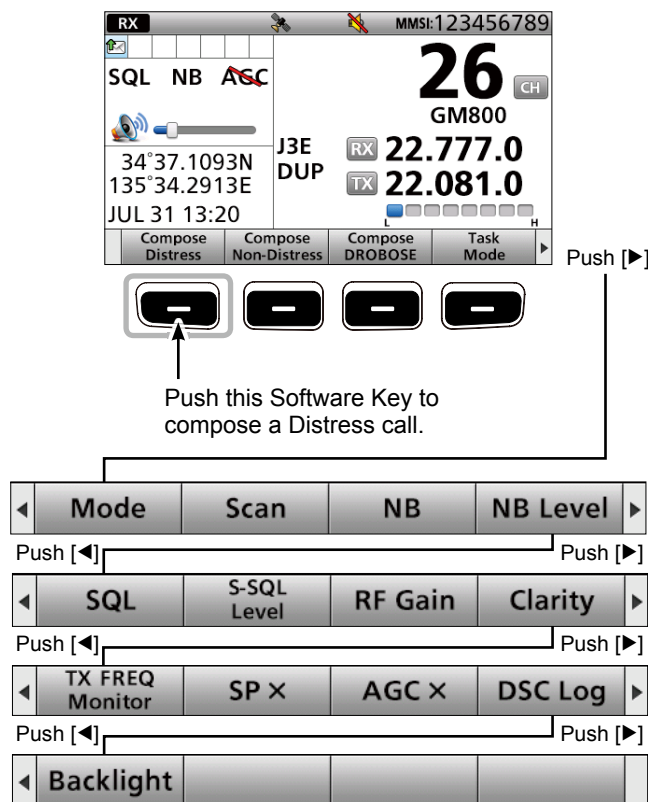

■ Software Key function

◇ Functions

You can use various Software Key functions that are assigned to the Software Keys, as described below.

**Compose Distress**

Push to compose a Distress call. (pp. 30 ~ 42)

**Compose Non-Distress**

Push to compose DSC calls other than Distress calls. (pp. 43 ~ 56)

**Compose DROBOSE**

Push to compose a Distress Relay On Behalf Of Someone Else (DROBOSE) call. (p. 37)

**Task Mode**

When the transceiver has any DSC tasks, push to enter the DSC Task mode. (p. 29)

**Mode**

Push to select the J3E, H3E, LSB, J2B, F1B, or A1A operating mode.

**Scan**

Push to start or stop a scan. (p. 14)

**NB**

Push to turn the Noise Blanker (NB) function ON or OFF. (p. 15)

**NB Level**

Push to adjust the NB level. (p. 15)

**SQL**

Push to turn the Squelch function ON or OFF. (p. 15)

**S-SQL Level**

Push to adjust the S-meter Squelch (S-SQL) level. (p. 15)

**RF Gain**

Push to adjust the Radio Frequency (RF) gain level. (p. 16)

**Clarity**

Push to turn the Clarity Control function ON or OFF. (p. 16)

**TX Freq Monitor**

Push to check and monitor the transmit frequency. (p. 15)

**SP ×**

Push to turn the speaker output ON or OFF.

**AGC ×**

Push to turn the Automatic Gain Control (AGC) function ON or OFF. (p. 16)

**DSC Log**

Push to check the received DSC calls. (p. 69)

**Backlight**

Push to change the brightness of the backlight. (p. 13)

**TIP:** You can reassign the functions' place to meet your needs. (Soft Key 5 ~ Soft Key 20). For details about how to assign them, see page 20.

① Information

The first set of Software Key functions ([Compose Distress], [Compose Non-Distress], [Compose DROBOSE], and [Task Mode]) are fixed and cannot be reassigned.

Push [▶] to select the second set (Soft Key 5 ~ Soft Key 8), the third set (Soft Key 9 ~ Soft Key 12), the fourth set (Soft Key 13 ~ Soft Key 16), and the fifth set (Soft Key 17 ~ Soft Key 20) of Software Key functions.

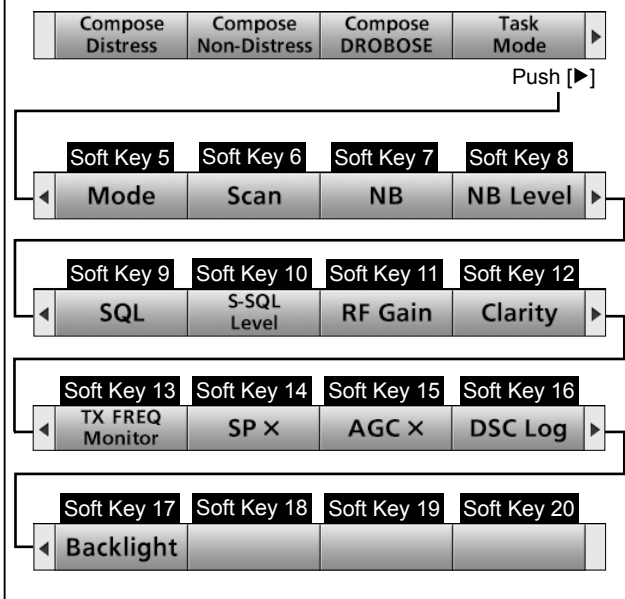

## ■ Function display (Main screen)

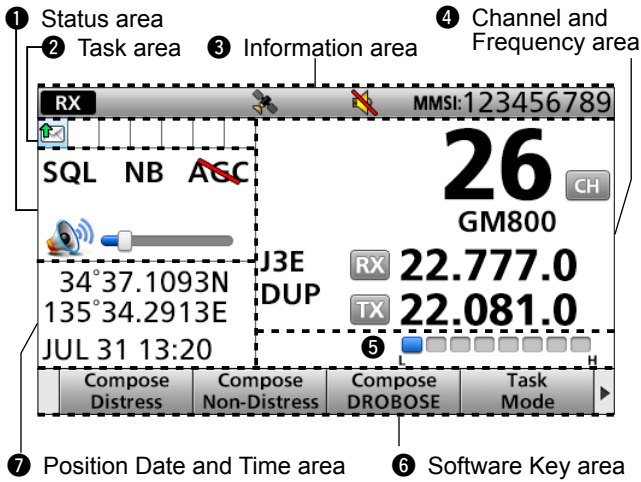

Display area	Description
<b>1 Status area</b>	Displays the current status.
<b>2 Task area</b>	Displays up to 7 task icons.
<b>3 Information area</b>	Displays various icons and the MMSI code.
<b>4 Channel and Frequency area</b>	Displays the selected operating channel information.
<b>5 S/RF Meter</b>	<ul style="list-style-type: none"> <li>Displays the relative signal strength of the receive signal.</li> <li>Displays the output power level of the transmit signal.</li> </ul>
<b>6 Software Key area</b>	Displays the key function for each Software Key.
<b>7 Position Date and Time area</b>	Displays the current position, date and time.

### ◇ Status area

Indication	Description
<b>Scan</b>	Displayed during a scan.
<b>NB</b>	Displayed when the Noise Blanker function is ON.
<b>SQL</b>	Displayed when the Squelch function is ON.
<b>ASC</b>	Displayed when the AGC function is OFF.

### ◇ Information area

The 9 digit MMSI (Maritime Mobile Service Identity: DSC self ID) code and the following indications are displayed in the Information area.

Indication	Description
<b>RX</b>	Displayed when receiving a signal or when the squelch is open.
<b>TX</b>	Displayed while transmitting.
	Displayed when the GPS receiver is activated and valid position data is received. Blinks while invalid position data is being received.
	Blinks when there is an unread DSC message.
	Displayed when the internal speaker is OFF.

### ◇ Channel and Frequency area

Indication	Description
<b>CH</b>	Displayed when the Channel Select mode is selected.
<b>GRP</b>	Displayed when the Group Select mode is selected.
<b>CLARITY + 20</b>	Displayed when the Clarity function is ON. The number displays the added or subtracted frequency.
<b>SIMP</b>	Displayed when a Simplex channel is selected.
<b>DUP</b>	Displayed when a Duplex channel is selected.
<b>J3E/H3E/LSB/J2B/F1B/A1A</b>	Displays the selected operating mode.

### ◇ Task area

Up to 7 task icons are displayed in the Task area when the transceiver has a task.

Indication	Description
<b>RT</b>	Displayed while in the Radio Telephone (RT) mode. <ul style="list-style-type: none"> <li>"<b>RT</b>" is displayed when the RT mode task is activated.</li> <li>Disappears if no operation occurs during the preset period of time.</li> </ul>
	Displayed after receiving a DSC call. <ul style="list-style-type: none"> <li>""</li> </ul> is displayed when the RX call task is activated.
	Displayed after making a DSC call. <ul style="list-style-type: none"> <li>""</li> </ul> is displayed when the TX call task is activated.

■ Function display (Main screen)

◇ Position Date and Time area

**POSITION AREA**

The current position is displayed when valid GPS data is received, or when you manually enter your position.

Indication	Description
<b>NO POSITION</b>	Displayed when a GPS receiver is not connected and the position has not been manually entered.
<b>??</b>	Blinks every 2 seconds instead of the position when the GPS position data is invalid. <ul style="list-style-type: none"> <li>• The last position is held for only 23.5 hours. After that, "NO POSITION" will be displayed.</li> </ul>
	Blinks every 2 seconds instead of the position after 4 hours have passed since you manually entered the position. <ul style="list-style-type: none"> <li>• The manually entered position is held for only 23.5 hours. After that, "NO POSITION" will be displayed.</li> </ul>

**DATE AND TIME AREA**

- The current time is displayed when valid GPS data is received, or manually enter the time.
- The date information is displayed when the RMC GPS sentence formats are included in the GPS signal.

Indication	Description
<b>NO TIME</b>	Displayed when a GPS receiver is not connected and the time has not been manually entered.
<b>Local</b>	Displayed when the offset time is set.
<b>Manual</b>	Displayed when the time is manually entered.
<b>UTC</b>	Displayed when the GGA, GLL or GNS GPS sentence formats are included in the GPS signal.
<b>??</b>	Blinks every 2 seconds instead of the time when the GPS current time is invalid. <ul style="list-style-type: none"> <li>• After 23.5 hours has passed, "NO TIME" will be displayed.</li> </ul>
	Blinks every 2 seconds instead of the time after 4 hours have passed since you manually entered the time. <ul style="list-style-type: none"> <li>• The manually entered time is held for only 23.5 hours. After that, "NO TIME" will be displayed.</li> </ul>

## ■ Entering the MMSI code

First, you must enter your 9 digit MMSI (Maritime Mobile Service Identity: DSC self ID) code at power ON.

**You can perform this initial code entry ONLY ONCE. After entry, only your dealer or distributor can change it. If you have already entered your MMSI code, these procedures are not necessary.**

Example: Entering the MMSI code (123456789).

1. Hold down [⏻] for 1 second to turn ON the transceiver.
  - Three short beeps sound.
  - “Push [ENT] to Register Your MMSI” is displayed.
2. Push [ENT].

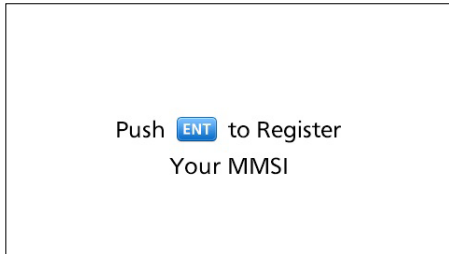

**NOTE:** Push [CLR] to cancel the entry. In that case, the transceiver displays “Push [ENT] to Register Your MMSI” again.

3. Enter your 9 digit MMSI code.

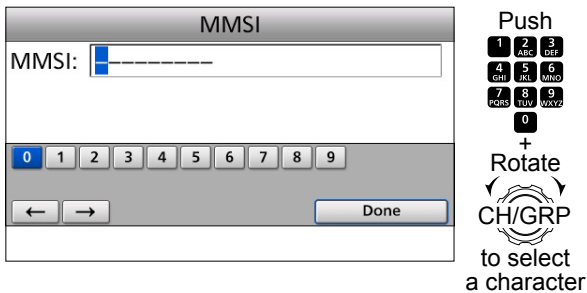

4. After entering the 9th digit, push [ENT].

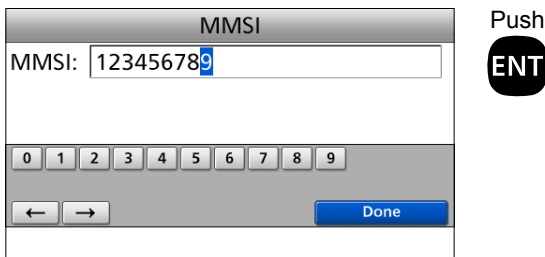

- The MMSI CONFIRMATION screen is displayed.

5. Reenter your MMSI code to confirm.

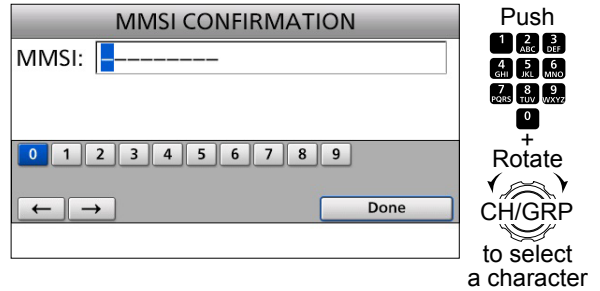

6. After entering the 9th digit, push [ENT].

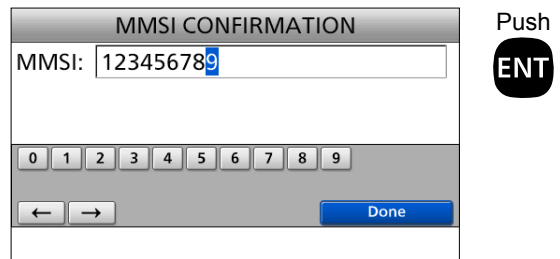

- The MMSI code is registered.

**NOTE:** When you successfully enter your MMSI code, the following screen is displayed.



After that, the Main screen is displayed. The registered MMSI code is displayed at the top of the screen.

### ⓘ Information

Rotate : Rotate [CH/GRP] to select.

Push : Push [ENT] to enter or set.

Push : Push the keypad keys to enter a digit or text.

2  
3

You can use the Menu screen to set infrequently changed values or function settings.

## Menu Construction

The Menu screen is constructed in a tree structure. You can go to the next tree level by pushing [ENT], or go back a level by pushing [CLR]. See the next page for details.

To select an item, rotate [CH/GRP].

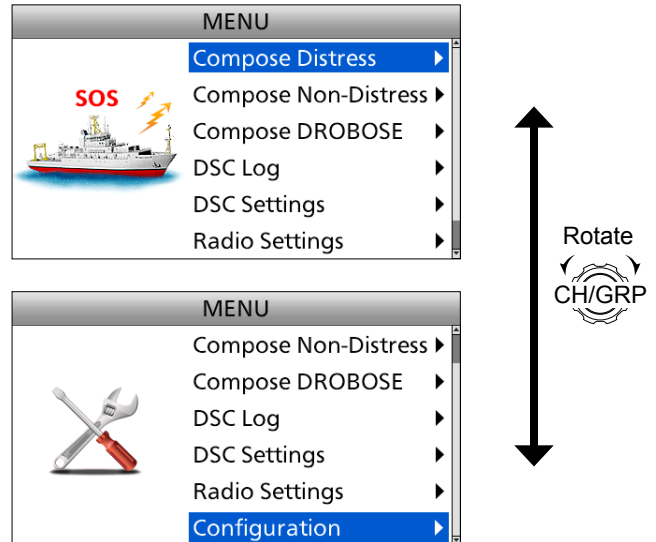

Compose Distress
Nature of Distress
Position
• Latitude
• Longitude
• UTC
Mode
Attempt

Compose Non-Distress
Message Type
Address* <sup>1</sup>
Area* <sup>1</sup>
• Latitude* <sup>1</sup>
• Longitude* <sup>1</sup>
• Radius* <sup>1</sup>
• Behind You* <sup>1</sup>
• To Your Right* <sup>1</sup>
Category
Call Frequency
• RX Frequency
• TX Frequency
Mode* <sup>1</sup>
Comm Frequency* <sup>1</sup>
• RX Frequency* <sup>1</sup>
• TX Frequency* <sup>1</sup>

Compose DROBOSE
Message Type
Address
Area* <sup>1</sup>
• Latitude* <sup>1</sup>
• Longitude* <sup>1</sup>
• Radius* <sup>1</sup>
• Behind You* <sup>1</sup>
• To Your Right* <sup>1</sup>
Distress ID
Nature of Distress
Position
• Latitude
• Longitude
• UTC
Call Frequency
• RX Frequency
• TX Frequency
Mode
Comm Frequency
• RX Frequency
• TX Frequency

DSC Log
Received Call Log
• Distress
• Others
Transmitted Call Log

DSC Settings
Position Input* <sup>2</sup>
Individual ID
Group ID
DSC Frequency
Individual ACK
Position ACK
Polling ACK
Test ACK
Medical Transports
Ships and Aircraft
Distress Scanning Receiver
10 Second Delay
Alarm Status
• Safety
• Routine
• Warning
• Self-Terminate
• Discrete
Auto Print
DSC Loop Test

Radio Settings
User CHAN
ITU Simplex CHAN
Max User CHAN
Auto Tune
Scan
Voice SQL

Configuration
Key Beep
NMEA Data Output
• DSC Data Output
Assignment
UTC Offset
Inactivity Timer
• Not DSC Related
• DSC Related
• RT Related-J3E/ H3E/LSB/J2B/F1B/ A1A
• Distress Related
MIC Key
Software Version

\*<sup>1</sup> These items may not be displayed, depending on the "Message Type" option.

\*<sup>2</sup> This item is not displayed when valid GPS data is received.

## ■ Selecting the item

Follow the procedures described below to select a Menu item.

Example: Turning ON the Voice Squelch function.

1. Push [MENU].
2. Select "Radio Settings."

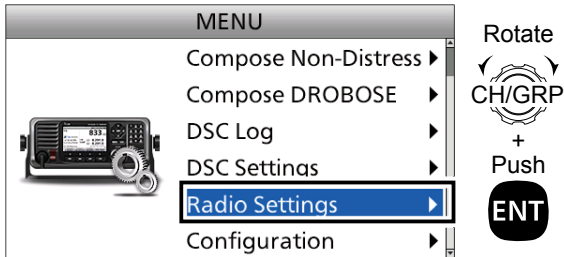

3. Select "Voice SQL."

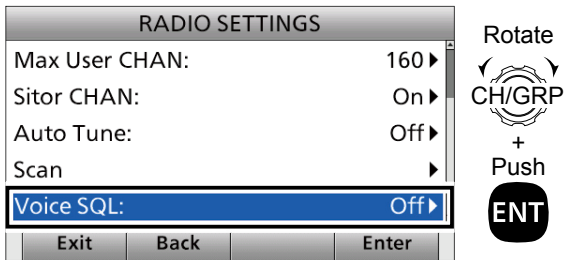

4. Select "On."

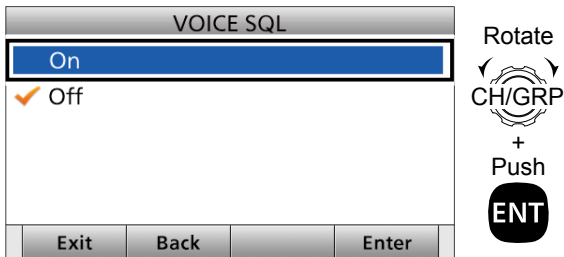

• Returns to the "RADIO SETTINGS" screen.

5. Push [MENU] to return to the Main screen.

### ① Information

You can use the following key functions in the MENU screen.

FUNCTION	ACTION
Select	Rotate [CH/GRP], or Push [▲] or [▼]
Enter	Push [ENT], Push [CH/GRP], or Push [Enter]
Go to the next tree level	Push [ENT] or Push [▶]
Go back to the previous tree level	Push [CLR], Push [◀], or Push [Back]
Cancel	Push [CLR]
Exit	Push [Exit]

Rotate : Rotate [CH/GRP] to select.

Push : Push [ENT] to enter or set.

Push : Push the keypad keys to enter a digit or text.

### ■ Selecting a Channel or Group

#### ◇ Using the channel and group selector

1. Push [CH/GRP] to toggle the Channel Select mode or the Group Select mode.
  - “CH” or “GRP” is displayed.
2. Rotate [CH/GRP] to select a channel or group.

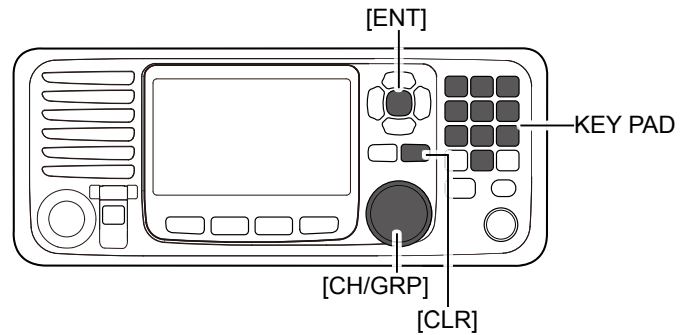

#### Example

When selecting the Group Select mode, the User channels change in 20 channel steps.

**NOTE:** See the Channel and Channel Group list below.

#### • Channel Select mode

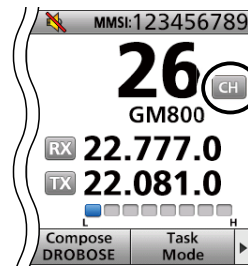

#### • Group Select mode

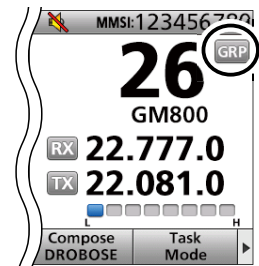

#### ◇ Using the keypad

##### • When selecting a User channel

1. Push the keypad keys to enter the channel number.
2. Push [ENT] to set.

#### Example

- Selecting CH 41: [4 GHI] → [1] → [ENT]
- Selecting CH 128: [1] → [2 ABC] → [8 TUV] → [ENT]

##### • When selecting an ITU duplex channel

1. Push the keypad keys to enter the channel number.
2. Push [ENT] to set.

#### Example

- Selecting CH 401: [4 GHI] → [0] → [1] → [ENT]
- Selecting CH 2505: [2 ABC] → [5 JKL] → [0] → [5 JKL] → [ENT]

#### NOTE:

- See the Channel and Channel Group list below.
- Pushing [CLR] clears the entered digits and return to the previous channel.

##### • When selecting an ITU simplex channel

1. Push the keypad keys to select a frequency band.
2. Push the left most Software Key to enter “-” (dash).

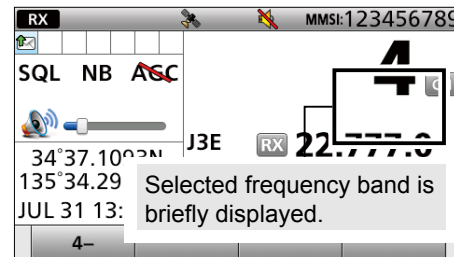

3. Push the keypad keys to enter the channel number.
4. Push [ENT] to set.

#### Example

- Selecting CH 4-1: [4 GHI] → [-] → [1] → [ENT]
- Selecting CH 25-2: [2 ABC] → [5 JKL] → [-] → [2 ABC] → [ENT]

#### • Channel and Channel Group list

Channel No.	Description	Channel No.	Description	Channel No.	Description
1 ~ 160	User CH*	1201 ~ 1241	12 MHz ITU duplex CH	22-1 ~ 22-9	22 MHz ITU simplex CH
401 ~ 429	4 MHz ITU duplex CH	12-1 ~ 12-9	12 MHz ITU simplex CH	2501 ~ 2510	25 MHz ITU duplex CH
4-1 ~ 4-9	4 MHz ITU simplex CH	1601 ~ 1656	16 MHz ITU duplex CH	25-1 ~ 25-9	25 MHz ITU simplex CH
601 ~ 608	6 MHz ITU duplex CH	16-1 ~ 16-9	16 MHz ITU simplex CH	C1-1 ~ C1-21	C1 channels
6-1 ~ 6-9	6 MHz ITU simplex CH	1801 ~ 1815	18 MHz ITU duplex CH	C2-1 ~ C2-31	C2 channels
801 ~ 837	8 MHz ITU duplex CH	18-1 ~ 18-9	18 MHz ITU simplex CH		
8-1 ~ 8-9	8 MHz ITU simplex CH	2201 ~ 2253	22 MHz ITU duplex CH		

\* [GRP] changes in 20 channel steps.



## Receiving and transmitting

### Receiving

1. Select a channel by rotating [CH/GRP], or pushing the keypad keys. (p. 11)
2. When receiving a call, rotate [VOL] to adjust the audio output level.

**TIP:**

When a call is received:

- The **RX** icon is displayed.
- You can hear receive audio from the speaker.
- The S-meter displays the received signal strength.

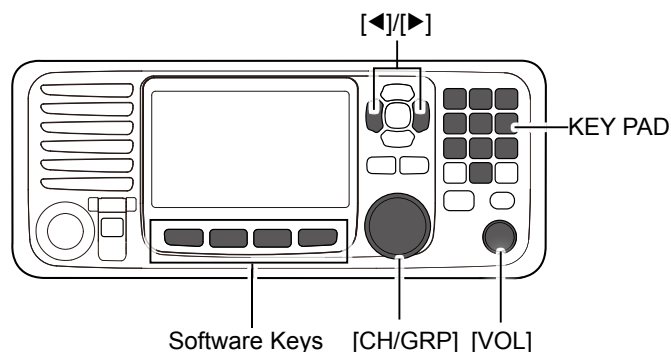

### Transmitting

1. Select a channel by rotating [CH/GRP] or pushing the keypad keys. (p. 11)
2. Push [◀] or [▶] to display “TX FREQ Monitor” in the Software Key area.
3. Hold down [TX FREQ Monitor] to temporarily monitor the transmit frequency of the selected channel.
  - The transmit frequency is displayed and **TX** blinks.

**NOTE:** If the channel is busy, wait until it becomes clear, or change to another channel.

4. Hold down [PTT] on the handset to transmit.
  - **TX** is displayed.

**NOTE:** If “SWR” is displayed during the transmission, check your antenna system.

5. Speak into the microphone at your normal voice level.
6. Release [PTT] to receive.
  - **RX** is displayed.

**NOTE: For the Time-out Timer (TOT) function**

The TOT function inhibits continuous transmission beyond a preset time period after the transmission starts. 10 seconds before transmission is cut off, a beep sounds to indicate the transmission will be cut off. Release [PTT] once to end your transmission and reset the timer. You cannot transmit for 10 seconds after it is cut off.

**IMPORTANT:** To maximize the readability of your transmitted signal, pause for a second after pushing [PTT], and then hold the handset 5 to 10 cm from your mouth and speak at your normal voice level.

## DSC scan

To receive a DSC call, such as an Individual call or a Group call, push [D-SCAN] to enter the DSC watch mode.

DSC Scan	
Distress: 2M — 4M	
Routine: 2.177.0	
4.219.5	
6.331.0	
8.436.5	
12.657.0	
16.903.0	
09:00 Manual	
Compose Distress	Compose Non-Distress
Compose DROBOSE	Task Mode

DSC watch mode

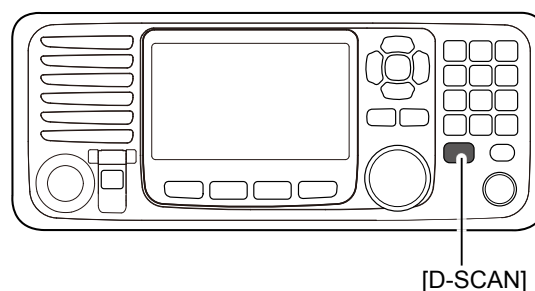

**NOTE:** The following frequencies are always automatically monitored with this transceiver.

2187.5, 4207.5, 6312.0, 8414.5, 12577.0, and 16804.5 kHz

## ■ Backlight function

The function display and keys can be backlit for better visibility under low light conditions.

You can set the Backlight mode to Day mode or Night mode. The Day mode is for the daytime operation, and the screen items are in color. The Night mode is for the nighttime operation, and the screen items are in black and red.

1. Push [◀] or [▶] until “Backlight” is displayed in the Software Key area.

2. Push [Backlight]  to open the Backlight setting window.

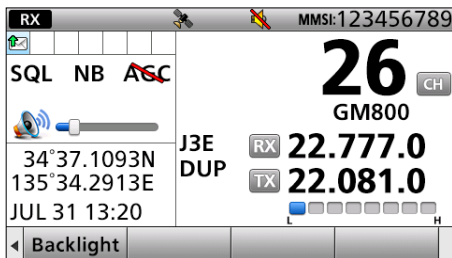

3. Push [▲] or [▼] to select “Day Mode” or “Night Mode.”

① In the Backlight Setting window, if you push no key for about 5 seconds, the transceiver automatically returns to the Main screen.

### Day mode

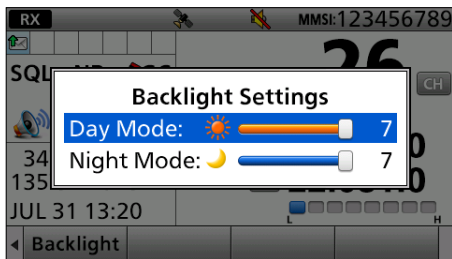

### Night mode

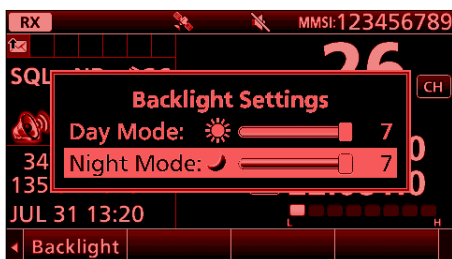

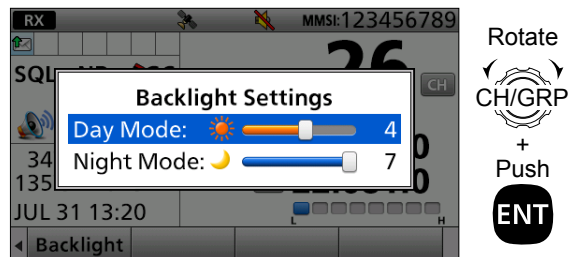

4. Rotate [CH/ENT] to adjust the backlight level, then push [ENT].



① The backlight level is adjustable in 7 levels and “OFF.” “OFF” is selectable only in the Day mode.

### ① Information

Rotate  : Rotate [CH/GRP] to select.

Push  : Push [ENT] to enter or set.

Push  : Push the keypad keys to enter digits or text.

## ■ Scan

The transceiver has automatic channel or frequency scan capabilities (Scan function). There are 3 types of scan functions.

- Channel scan
- Channel Resume scan
- Programmed scan

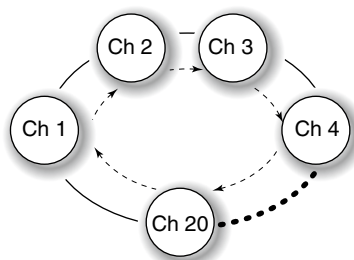

### ◇ Channel scan and Channel Resume scan

Channel scan and Channel Resume scan channels within a 20 channel range, such as Ch 1 to Ch 20, Ch 141 to Ch 160, and so on, in user channels, or all channels in the group of ITU channels.



**Channel scan:**  
The scan does not pause, even if a signal is received.

**Channel Resume scan:**  
The scan pauses for 10 seconds, then resumes, or resumes after 2 seconds from when the signal disappears.

1. Rotate [GRP/CH] to select a channel group. (p. 11)
2. Push [◀] or [▶] until "Scan" is displayed in the Software Key area.
3. Push [Scan]  to start a scan.
4. Push [Scan]  again to stop the scan.



Select a scan type in the Menu screen.  
See page 76 for details.

### ◇ Programmed scan

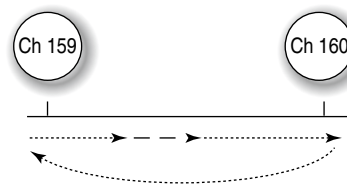
The Programmed scan scans frequencies in the frequency range between user channels.



**Example:**  
Scans the frequencies between channels 159 and 160.  
Scans quickly when the squelch is closed.  
Scans slowly when the squelch is open.

1. Push [◀] or [▶] until "SQL" is displayed in the Software Key area.
2. Push [SQL]  to turn OFF the squelch function.
3. Push [◀] or [▶] until "Scan" is displayed in the Software Key area.
4. Push [Scan]  to start a scan.
5. Push [Scan]  again to stop the scan.

## ■ Other functions

### ◇ Transmit Frequency Monitor function

When selecting a duplex channel, the transmit frequency differs from the receive frequency. To prevent from interference to other stations, the transmit frequency should be monitored before you transmit.

1. Push [◀] or [▶] until “TX FREQ Monitor” is displayed in the Software Key area.
2. Hold down [TX FREQ Monitor]  to monitor the transmit frequency.  
① “TX” blinks and the transmit frequency is displayed.

### ◇ Squelch function

The Squelch function mutes unwanted signals such as noise or unmodulated beat signals. This function enables quiet standby. However, when you need to receive weak signals, adjust the Squelch level, or turn OFF the function.

1. Push [◀] or [▶] until “SQL” is displayed in the Software Key area.
2. Push [SQL]  to turn the function ON or OFF.  
① When the function is ON, **SQL** is displayed.

### ◇ S-meter squelch level

When the Squelch function is ON, only signals stronger than this set level are received. Set to between 1 (open) and 100 (tight).

1. Push [◀] or [▶] until “S-SQL Level” is displayed in the Software Key area.
2. Push [S-SQL Level] .  
• The S-SQL level setting window is displayed.
3. Rotate [CH/GRP] to adjust the S-meter squelch level.

### ◇ Noise Blanker function

The Noise Blanker function reduces pulse-type noises that come from engine ignitions. However, when the received strong signals are distorted, adjust the Noise blanker level or turn OFF the function.

1. Push [◀] or [▶] until “NB” is displayed in the Software Key area.
2. Push [NB]  to turn the function ON or OFF.  
① When the function is ON, “NB” is displayed.

### ◇ Noise blanker level

When the Noise Blanker function is ON, adjust the Noise blanker level to reduce various pulse-type noises. Set to between 1 and 10.

1. Push [◀] or [▶] until “NB Level” is displayed in the Software Key area.
2. Push [NB Level] .  
• The NB level setting window is displayed.
3. Rotate [CH/GRP] to adjust the Noise Blanker level.

### ◇ Automatic Gain Control OFF

The Automatic Gain Control (AGC) function prevents distortion from strong signals and maintains a constant output level.

To receive weak signals, turn OFF the Automatic Gain Control function.

1. Push [◀] or [▶] until "AGC x" is displayed in the Software Key area.
2. Push [AGC x]  to turn OFF the function.
  - ① When the function is OFF, "AGC x" is displayed.

### ◇ RF gain level

To receive weak signals, you can set the minimum RF (Radio Frequency) gain level needed. Set to between 0 and 9.

1. Push [◀] or [▶] until "RF Gain" is displayed in the Software Key area.
2. Push [RF Gain] 
  - The RF gain level setting window is displayed.
3. Rotate [CH/GRP] to adjust the RF gain level.

### ◇ Clarity Control function

With the Clarity Control function, you can slightly shift the receive frequency without changing the operating frequency to finely tune. When the Clarity Control function is ON, adjust the clarity control level.

1. Push [◀] or [▶] until "Clarity" is displayed in the Software Key area.
2. Push [Clarity]  to turn the function ON or OFF.
  - ① When the function is ON, "CLARITY + 20" is displayed.
3. Rotate [CH/GRP] to adjust the clarity control.

### ◇ Automatic Antenna Tuner function

When using the AT-141 with the GM800, you can use the Tuner Through function.

- Push to turn ON the Automatic Antenna Tuner function, or to bypass the tuning circuit.
- Hold down to start manual tuning.
  - ① After tuning is completed, "TUNE" is displayed.
  - ① When the tuner cannot tune the antenna, "THRU" is displayed.

## ■ Setting a temporary operating frequency

You can temporarily change the operating frequency of the selected channel. The frequency returns to the preset value after you select another channel, or turn OFF the transceiver.

1. Select a channel that is programmed near the frequency you want to receive.
2. Push [RX/TX] to select the RX mode.
  - The RX icon lights blue.

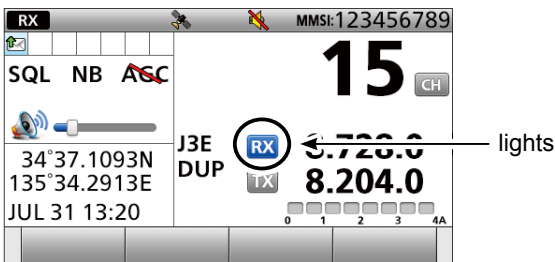

3. Enter an RX frequency, then push [ENT].

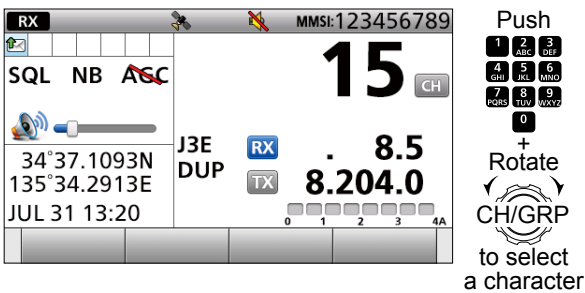

**NOTE:** Quickly enter a temporary operating RX frequency and push [ENT]. Otherwise, it automatically returns to the preset value soon.

4. Push [RX/TX] to select the TX mode.
  - The TX icon lights blue.

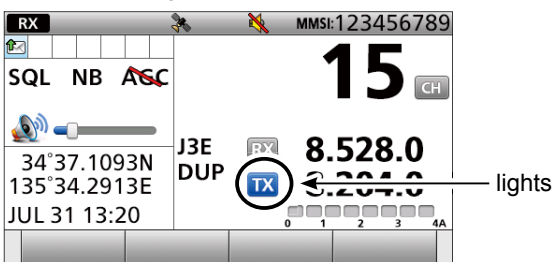

5. Enter a TX frequency, then push [ENT].

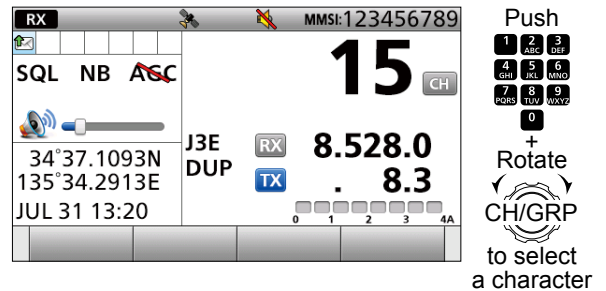

**NOTE:** Quickly enter a temporary operating TX frequency and push [ENT]. Otherwise, it automatically returns to the preset value soon.

**NOTE:**

- If you enter a frequency that is out of the frequency range, an error beep sounds and it automatically returns to the preset value.
- **BE SURE** to push [ENT] after entering a frequency. Otherwise, it automatically returns to the preset value after 2 seconds.

## ■ Setting a User channel or an ITU Simplex channel

Your dealer has already preset User channels and ITU Simplex channels. Follow the instructions as described below, only when you need to edit the channels.

You can edit the following information of a User channel or an ITU Simplex channel.

- Operating frequency
- Operating mode
- Channel name

### 1. Entering the Channel Edit screen

1. Push [MENU].
2. Select "Radio Settings."

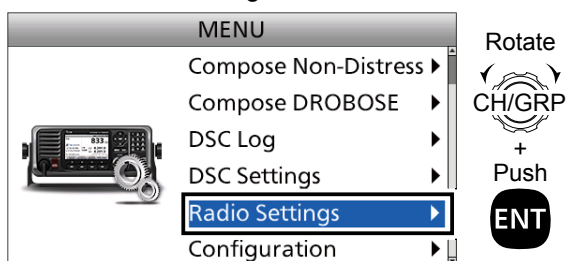

3. Select "User CHAN" or "ITU Simplex CHAN." (Example: User CHAN)

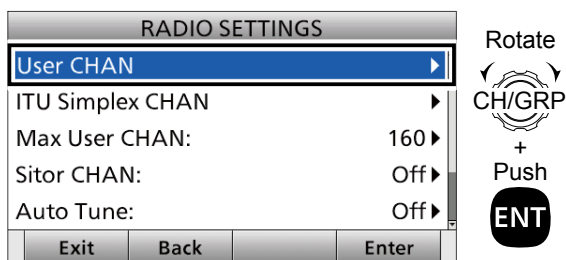

4. Select a channel you want to edit and push [Edit] . (Example: CH 159)

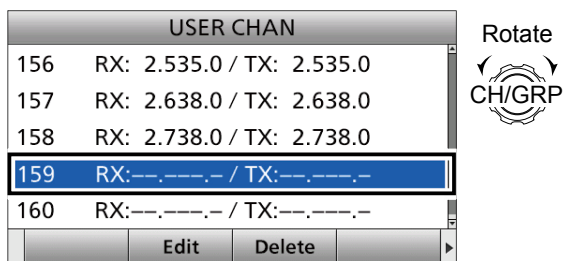

#### NOTE:

- If you edit the preset channels, you may not be able to communicate with other ships.
- The following instructions are for a User channel Editing. However, you can set an ITU Simplex channel name in the same way.

### 2. Setting an RX and TX operating frequencies

**NOTE:** The RX and TX operating frequency are the same when you select an ITU Simplex channel.

5. Select "RX frequency."

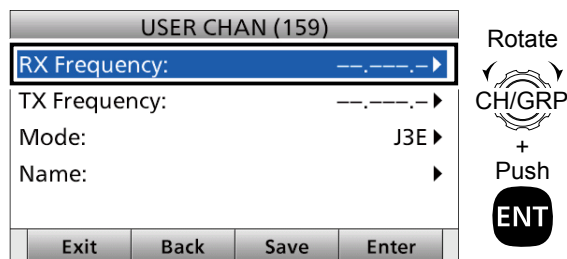

6. Enter an RX frequency. After entering, push [ $\blacktriangle$ ], [ $\blacktriangledown$ ], [ $\blacktriangleleft$ ], or [ $\blacktriangleright$ ] to select "Done" and push [ENT]. (Example: 4.390.0)

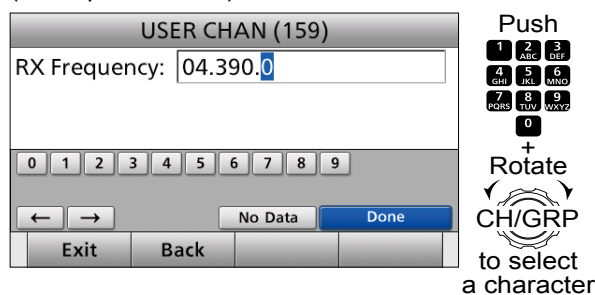

7. Select "TX frequency."

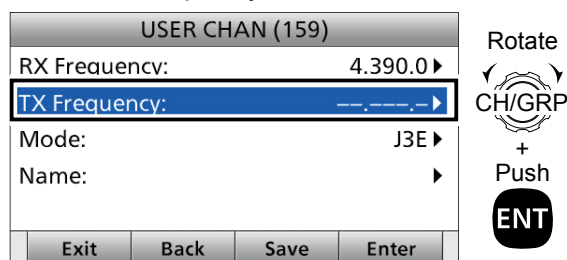

## 6 OTHER FUNCTIONS AND OPERATIONS

### ■ Setting a User channel or an ITU Simplex channel

#### 2. Setting an RX and TX operating frequencies (continued)

8. Enter a TX frequency.  
After entering, push [▲], [▼], [◀], or [▶] to select “Done” and push [ENT]. (Example: 4.098.0)

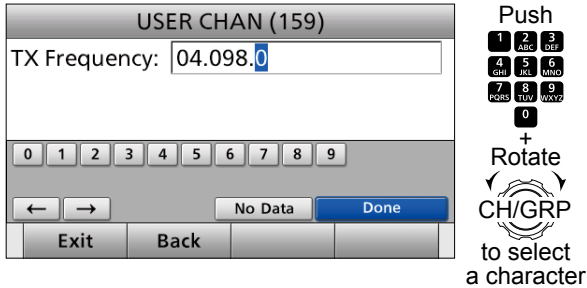

#### 3. Setting an operating mode

9. Select “Mode.”

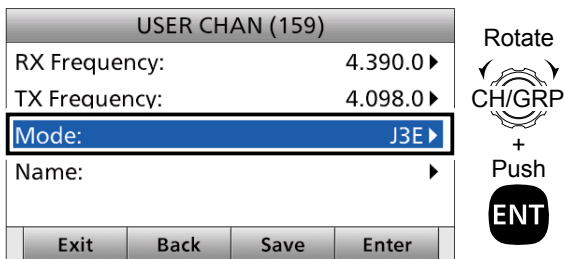

10. Select an operating mode. (Example: J3E)

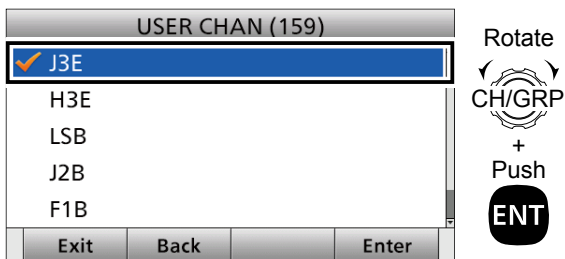

#### 4. Setting a channel name

You can set a channel name of up to 10 characters for each User and ITU channel. This may be helpful to indicate the frequency's use, or a ship's name.

11. Select “Name.”

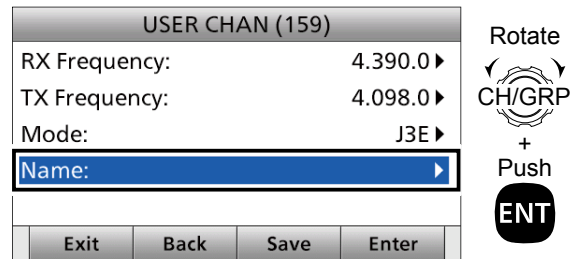

12. Enter a channel name.

After entering, push [▲], [▼], [◀], or [▶] to select “Done” and push [ENT].

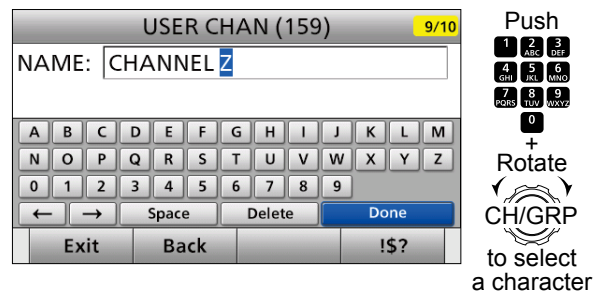

13. Push [Save].

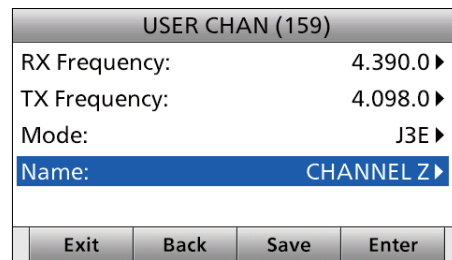

• “Are you sure ?” is displayed.

14. Push [OK]  to save the name.  
15. Push [MENU] to return to the Main screen.



## ■ Assigning a function

You can assign some different Software Key functions to a key between Soft Key 5 and Soft Key 20. (p. 5)

You can also assign some Software Key functions to [VOL] on the controller and [P] on the optional HM-214H MICROPHONE.

### ◇ Assigning a Software Key function to a Software Key

Example: Assigning “NB” to “Soft Key 18.”

1. Push [MENU].
2. Select “Configuration.”

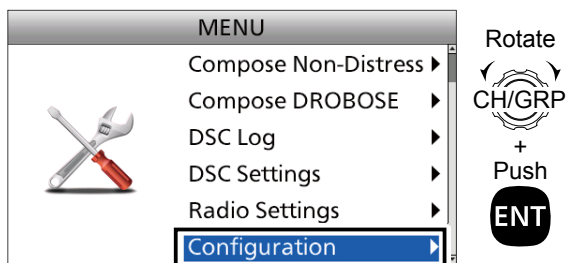

3. Select “Assignment.”

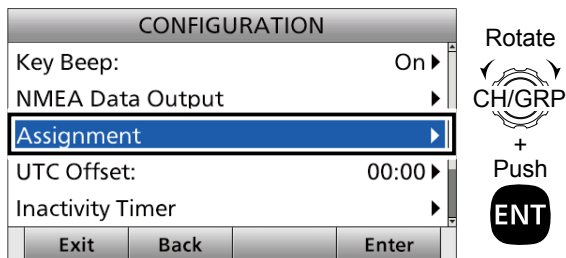

4. Select “Key Assignment.”

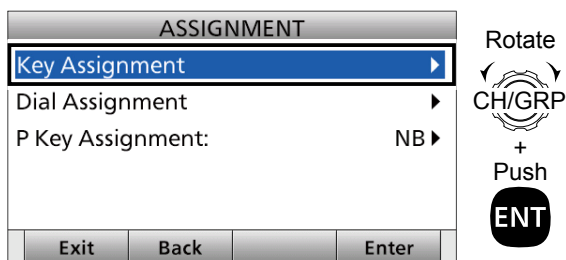

5. Select a place. (Example: Soft Key 18)

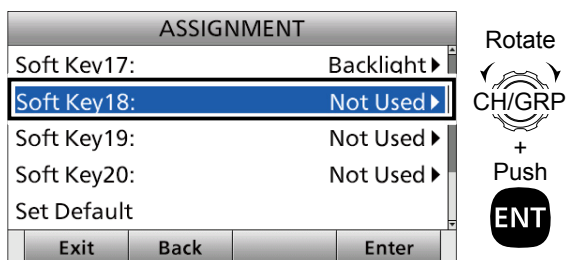

6. Select a Software Key function. (Example: NB)

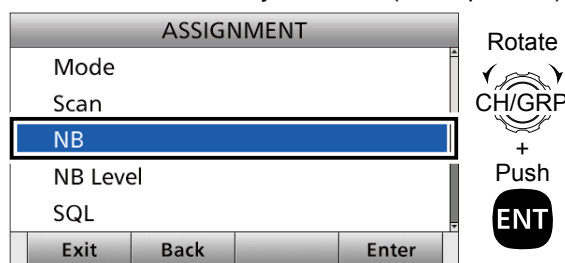

• “NB” is assigned to “Soft Key 18.”

7. Push [Exit] to return to the Main screen.

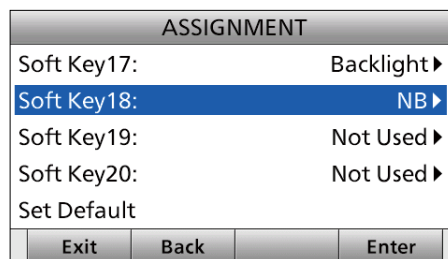

**TIP:** You can confirm “NB” is assigned to a Software Key after returning to the Main screen.

Push [◀] or [▶] to the Soft Key 18’s place.

• “NB” is displayed in the Software Key area.

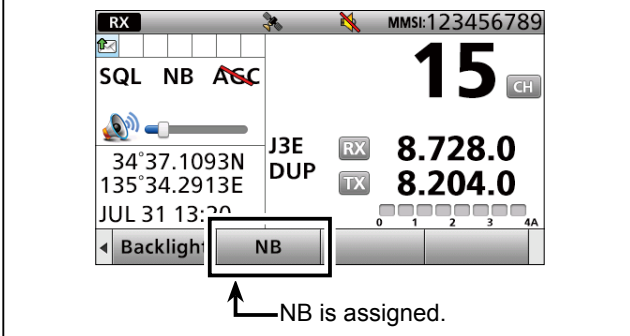

■ Assigning a function

◇ Assigning a Software Key function to [VOL]

Example: Assigning “Backlight” to “Push x3.”

1. Push [MENU].
2. Select “Configuration.”

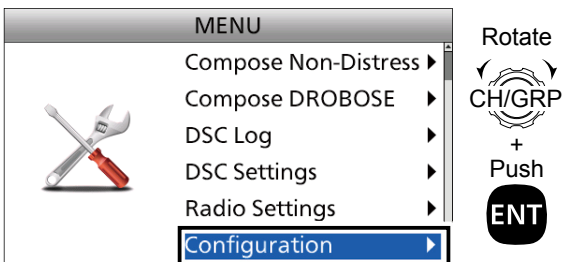

3. Select “Assignment.”

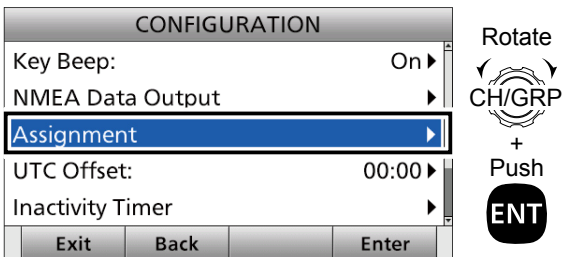

4. Select “Dial Assignment.”

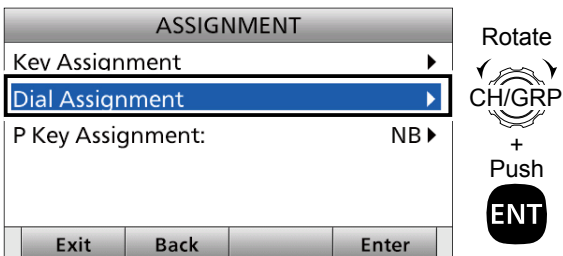

5. Select a place. (Example: Push x3)

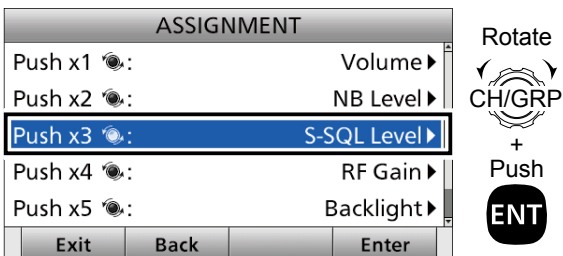

6. Select a Software Key function. (Example: Backlight)

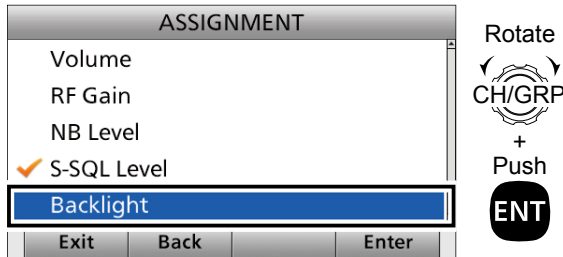

• “Backlight” is assigned to “Push x3.”

7. Push [Exit] to return to the Main screen.

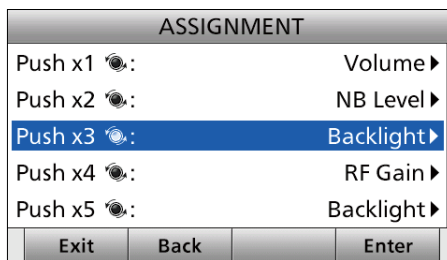

**TIP:** You can confirm “Backlight” is assigned to “Push x3” after returning to the Main screen.

Push [VOL] 3 times.

• Backlight setting window is displayed.

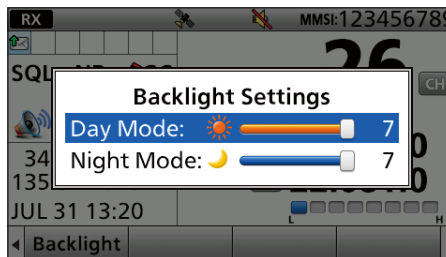

### ◇ Assigning a Software Key function to [P] on the HM-214H MICROPHONE

Example: Assigning “Mode” to [P].

1. Push [MENU].
2. Select “Configuration.”

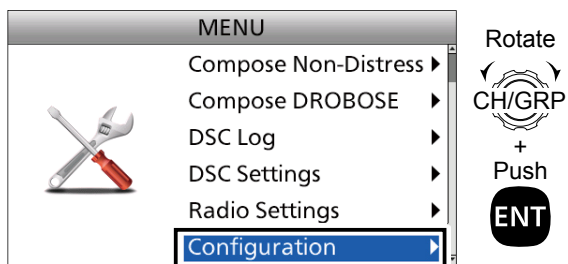

3. Select “Assignment.”

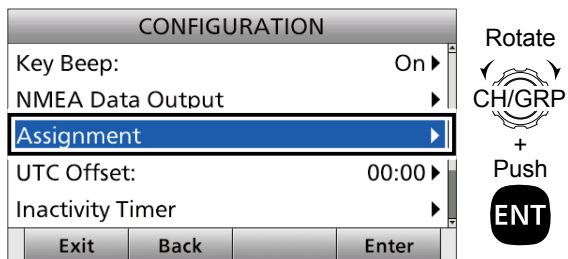

4. Select “P Key Assignment.”

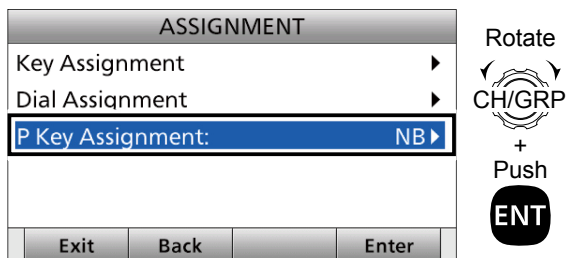

5. Select a Software Key function. (Example: Mode)

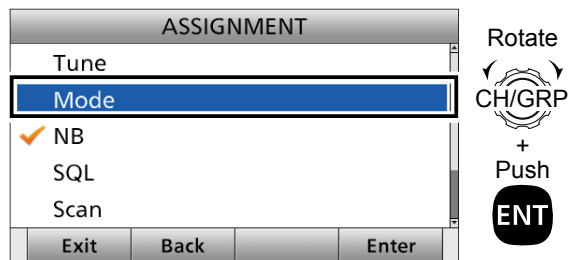

• “Mode” is assigned to [P].

6. Push [Exit]  to return to the Main screen.

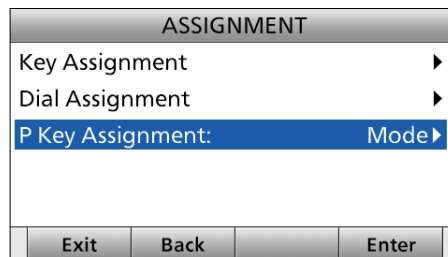

**TIP:** You can confirm “Mode” is assigned to [P] after returning to the Main screen.

Push [P] on the HM-214H MICROPHONE.  
 • The operating mode changes.

## ■ DSC address ID

You can enter a total of 100 DSC address IDs, and assign a name of up to 10 characters to each ID.



**① Information**

Rotate  : Rotate [CH/GRP] to select.

Push  : Push [ENT] to enter or set.

Push  : Push the keypad to enter digits or text.



**TIP:** You can use the following key operations in the Menu screen.

ACTION	OPERATION
Select	Rotate [CH/GRP] Push [▲] or [▼]
Enter	Push [ENT], [CH/GRP], or [Enter] 
Cancel	Push [CLR]
Exit	Push [Exit] 

### ◇ Entering an Individual ID

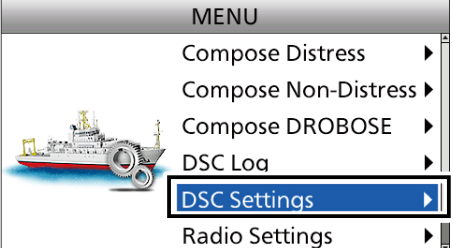

1. Push [MENU].
2. Select “DSC Settings.”

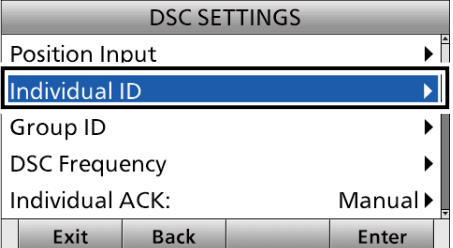

Rotate  + Push 

3. Select “Individual ID.”



Rotate  + Push 

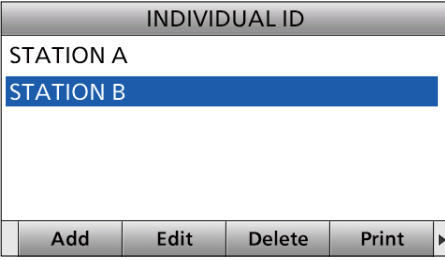

4. Push [Add] .



Push 

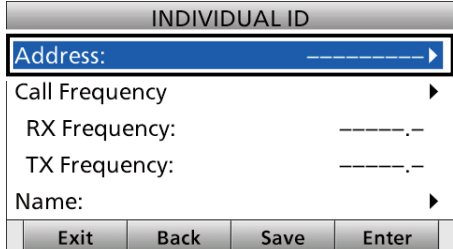

5. Select “Address.”

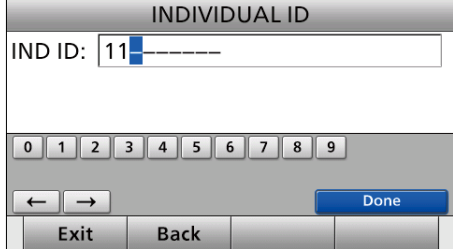

Rotate  + Push 

6. Enter a 9 digit Individual ID.  
After entering, push [▲], [▼], [◀], or [▶] to select “Done” and push [ENT].





Push  + Rotate  to select a character

- ① The first digit is specified as ‘0’ for a Group ID.
- ① The first 2 digits are ‘0’ for any Coast station ID.

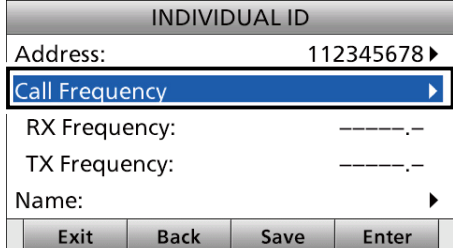
7. Select “Call Frequency.”



Rotate  + Push 

8. Enter an RX frequency.  
After entering, push [▲], [▼], [◀], or [▶] to select "Done" and push [ENT].

9. Enter a TX frequency.  
After entering, push [▲], [▼], [◀], or [▶] to select "Done" and push [ENT].

10. Select "Name."

11. Enter an Individual ID name.  
After entering, push [▲], [▼], [◀], or [▶] to select "Done" and push [ENT].

12. Push [Save] .

13. Push [OK]  to save the ID.

- The entered Individual ID is added to the ID list.
14. Push [MENU] to return to the Main screen.

■ DSC address ID

◇ Entering a Group ID

1. Push [MENU].
2. Select “DSC Settings.”

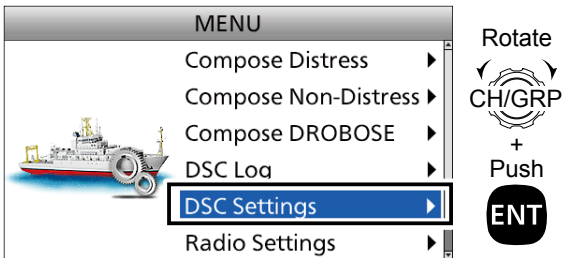

3. Select “Group ID.”

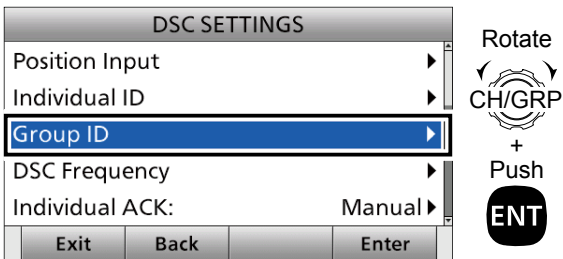

4. Push [Add] .

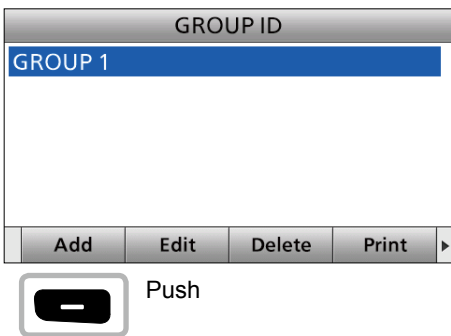

5. Select “Address.”

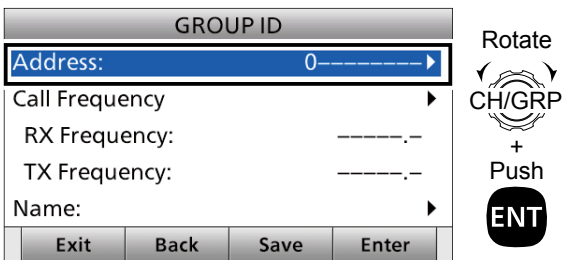

6. Enter a 9 digit Group ID. After entering, push [▲], [▼], [◀], or [▶] to select “Done” and push [ENT].

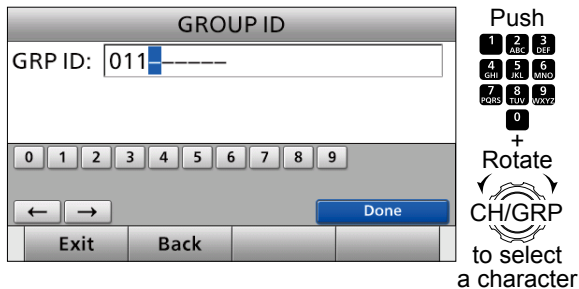

- ① The first digit is specified as '0' for a Group ID.
- ① The first 2 digits are '0' for any Coast station ID.

7. Select “Call Frequency.”

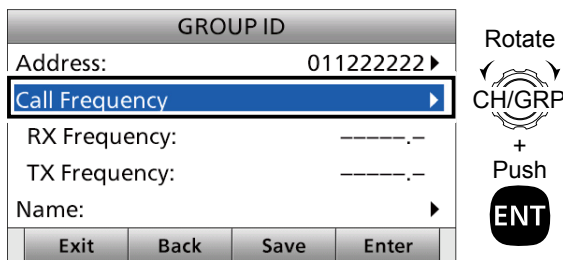

8. Enter an RX frequency. After entering, push [▲], [▼], [◀], or [▶] to select “Done” and push [ENT].

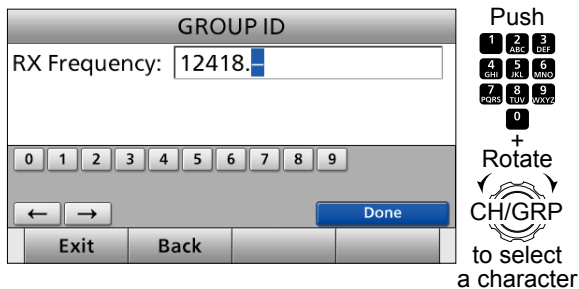

9. Enter a TX frequency. After entering, push [▲], [▼], [◀], or [▶] to select “Done” and push [ENT].

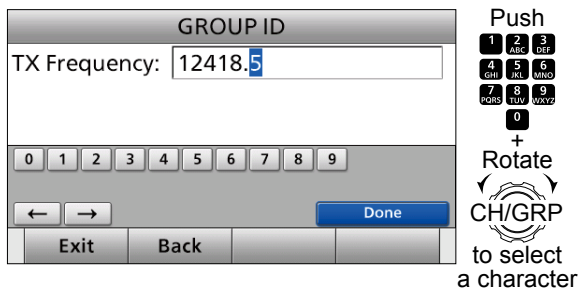

10. Select "Name."

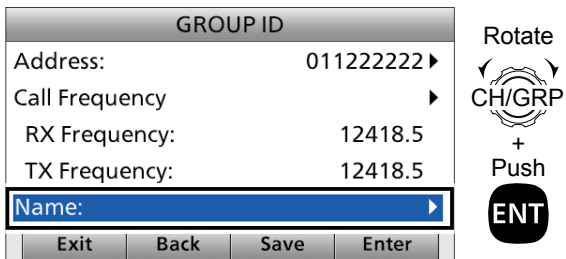

11. Enter a Group ID name. After entering, push [▲], [▼], [◀], or [▶] to select "Done" and push [ENT].



12. Push [Save] .

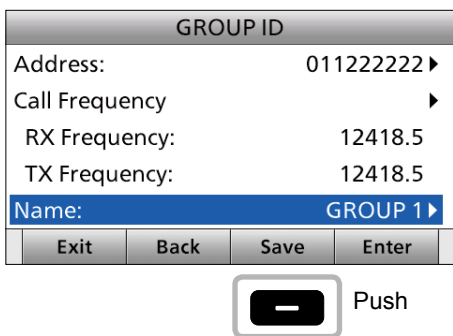

13. Push [OK]  to save the ID.

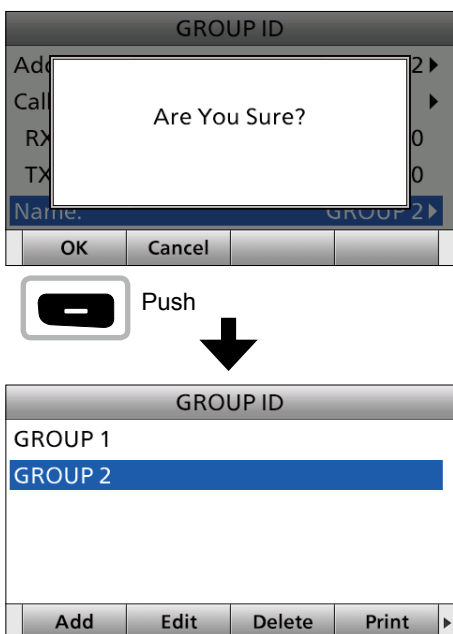

• The entered Group ID is added to the ID list.  
14. Push [MENU] to return to the Main screen.

### ◆ Deleting an entered ID

1. Push [MENU].
  - "MENU" screen is displayed.
2. Rotate [CH/GRP] to select "DSC Settings."
  - "DSC SETTING" screen is displayed.
3. Select "Individual ID" or "Group ID."
  - "INDIVIDUAL ID" or "GROUP ID" screen is displayed.
4. Rotate [CH/GRP] to select the ID to delete.
5. Push [Delete] .

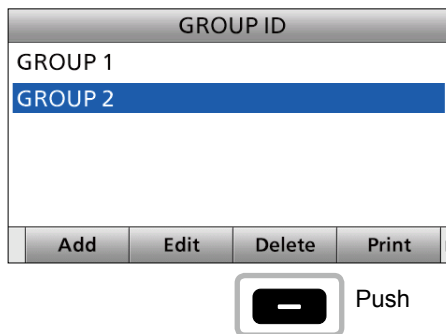

6. Push [OK] .

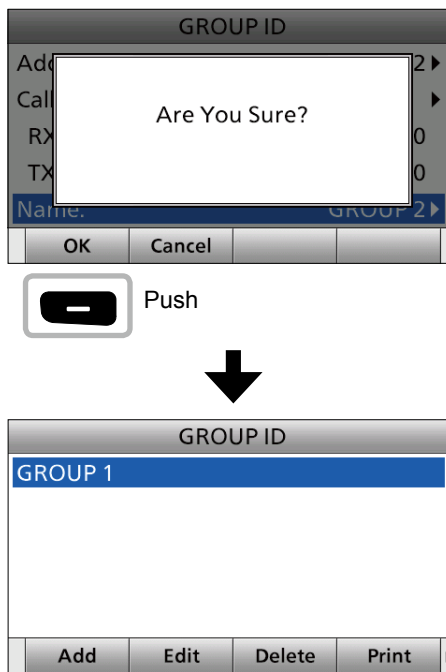

- The selected ID is deleted from the ID list.
7. Push [MENU] to return to the Main screen.

## ■ Entering position data and time

A Distress call should include the ship's position data and time. If a GPS receiver compatible with the IEC61162-1 Ed.4 (2010-11) format is connected, position and UTC time are automatically included. If no GPS is connected, you should manually enter your position data and UTC (Universal Time Coordinated) time.

**NOTE:**

- Manual entry is invalid when a GPS receiver is connected.
- Manually entered position data and time are valid for only 23.5 hours.

1. Push [MENU].
2. Select "DSC Settings."

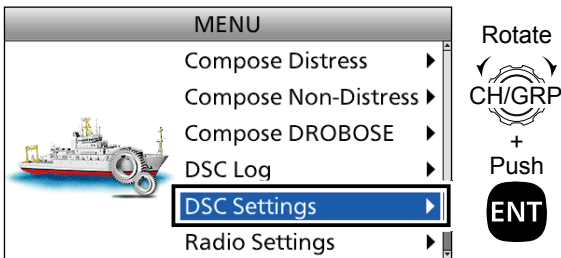

3. Select "Position Input."

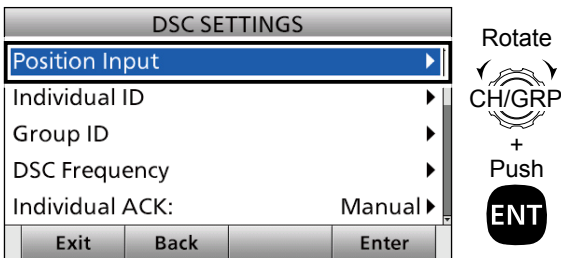

4. Enter your latitude.

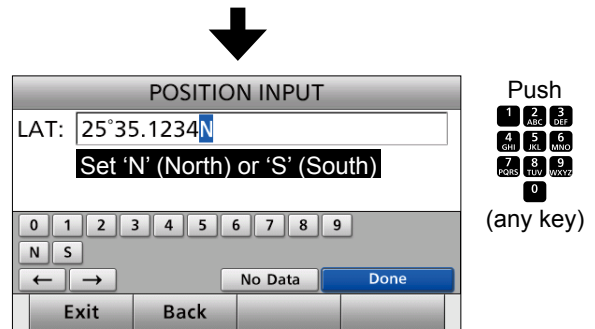
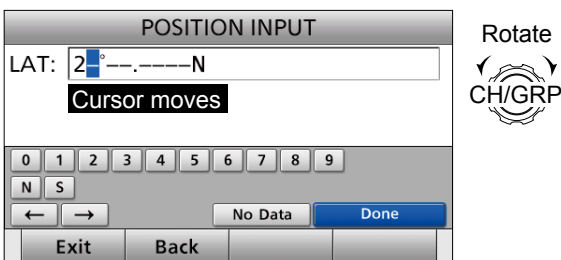
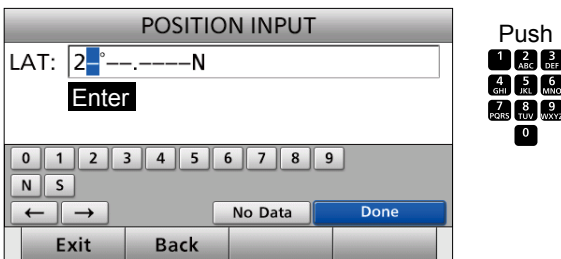

④ To select 'N' (North latitude) or 'S' (South latitude), push any key when the cursor is on the 'N' or 'S' position.

5. After entering, push [▲], [▼], [◀], or [▶] to select "Done" and push [ENT].
6. Enter your longitude.

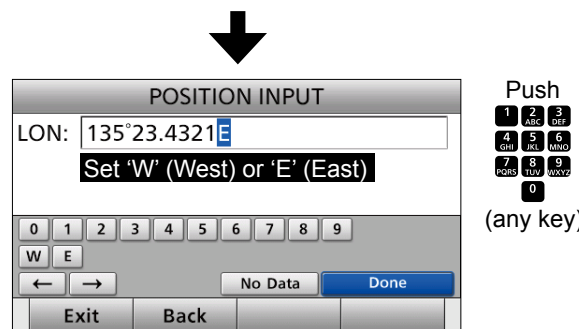
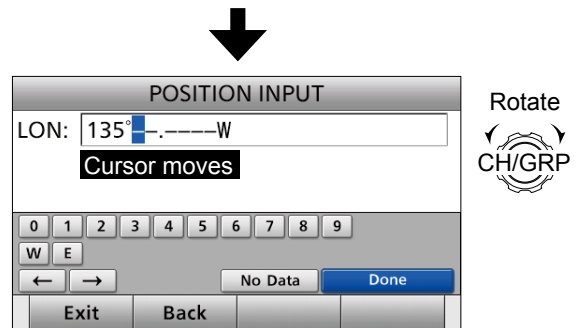
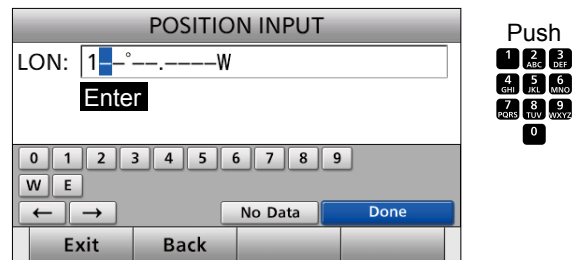

7. After entering, push [▲], [▼], [◀], or [▶] to select "Done" and push [ENT].



8. Enter your UTC time.

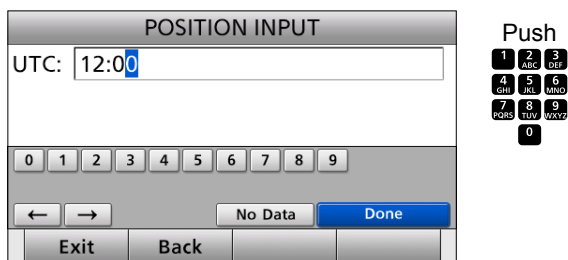
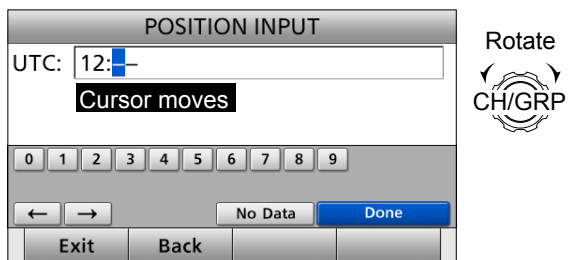
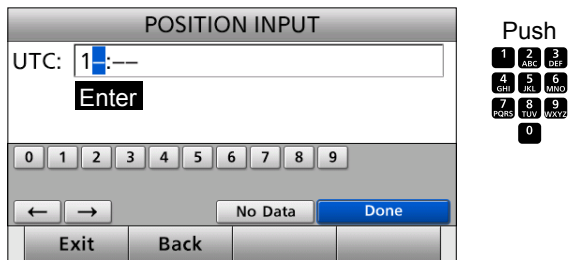

9. After entering, push [▲], [▼], [◀], or [▶] to select "Done" and push [ENT].
  - The DSC setting screen is displayed.
10. Push [MENU] to return to the Main screen.

**TIP:**

When position data and time are set, Latitude, Longitude and UTC Time are displayed.

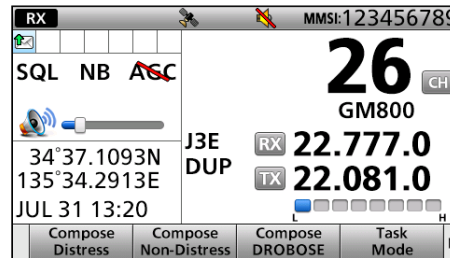

- Latitude: 34°37.1093N
- Longitude: 135°34.2913E
- UTC Time: 13:20

When no position data and time are set, "No Position" and "No Time" are displayed.

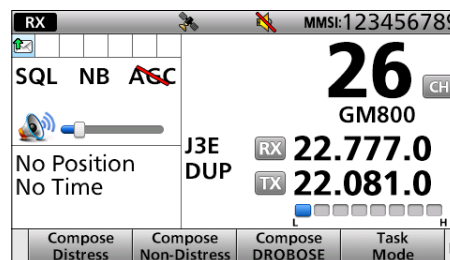

**Information**

**While entering:**

- To move the cursor:  
Rotate [CH/GRP].
- To correct the entry:  
Move the cursor to the character. And then, enter the correct character.
- To clear the entry:  
Push [▲], [▼], [◀], or [▶] to select "No Data." And then push [ENT].  
When the following screen is displayed, push [ENT].

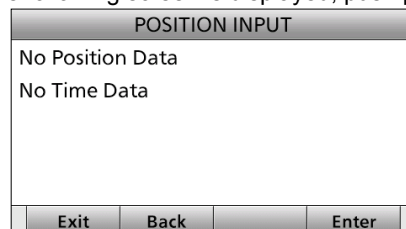

- To return to the Main screen:  
Push [Exit]
- To go back to the previous screen:  
Push [Back]

## ■ DSC Task mode

After sending or receiving the DSC call, the transceiver enters the DSC Task mode.

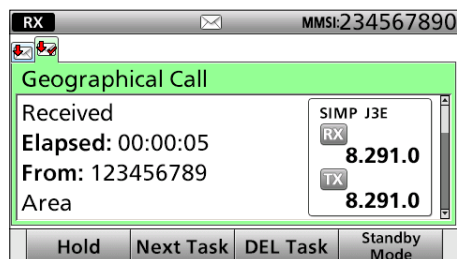

(Example: After receiving a Geographical call)

In the DSC Task mode, you can resend the call, or send an acknowledgement to the caller station.

- The transceiver can hold up to 7 DSC tasks.
- In the Standby mode, a task icon is displayed in the Task area, when the transceiver has a DSC task. (p. 6)
- When any DSC task icon is displayed in the Standby mode, you can enter the DSC Task mode by pushing [Task Mode] .

**NOTE:** The DSC Task mode has the Time-out Timer (TOT) function. When you push no key for a preset period, the transceiver automatically cancels the DSC Task mode.

The count down alarm sounds 10 seconds before the TOT activates.

No count down alarm sounds before Radio Telephone TOT activates.

The default settings of the TOT function:

- DSC Related: 15 minutes
- Distress Related: OFF

### ◇ About “Active” and “Hold”

The DSC Task mode has 2 statuses, “Active” and “Hold.” When you send the repeat call, or send an acknowledgement to the caller station, push [Active]  to display the Active window.

#### • Active window

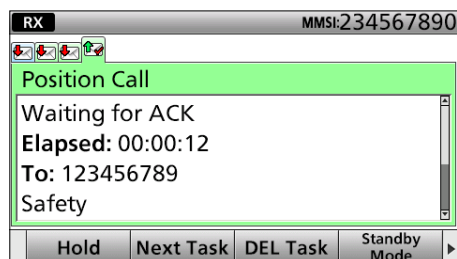

① “✓” is displayed on the active Task tab.

① To view the contents, rotate [CH/GRP].

#### • Hold window

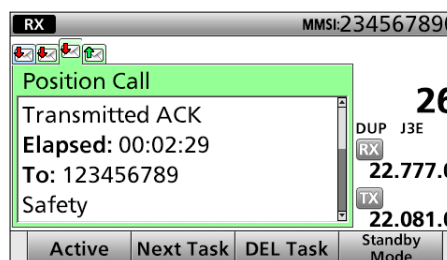

① To view the contents, push [▲] or [▼].

### ◇ Software Key functions

While in the DSC Task mode, the following functions are displayed first.

FUNCTION	DESCRIPTION
Hold	Push to cancel the Active Task window.
Active	Push to activate the selected Task window.
Next Task	Push to select other Task window.
DEL Task	Push to delete the Task window.
Standby Mode	Push to enter the Standby mode.

The following functions may be displayed, depending on the call type.

FUNCTION	DESCRIPTION
Cancel	Push to send a Cancel call.
Resend	Push to resend the call.
Pause	Push to pause the Call Repeat function.
Finish	Push to return to the Main screen.
ACK	Push to send an acknowledgement.
History	Push to display the Distress call history screen.
Relay	Push to send a Distress Relay call.

See the following pages for details of the DSC Task mode operation for each DSC call.

## ■ Sending a Distress call

**NOTE: NEVER** make a Distress call if your ship or a person is not in an emergency.  
A Distress call should be made only when immediate help is needed.

You should send a Distress call if, in the opinion of the Master, the ship or a person is in distress and requires immediate assistance.

- ① One of the Emergency frequencies is automatically selected to send a Distress call.

### ◇ Simple call

1. Confirm no Distress call is being received.
2. Lift up the key cover, then hold down [DISTRESS] until "Transmitting" is displayed to send a Distress call.



3. After sending, "Waiting for ACK" is displayed.

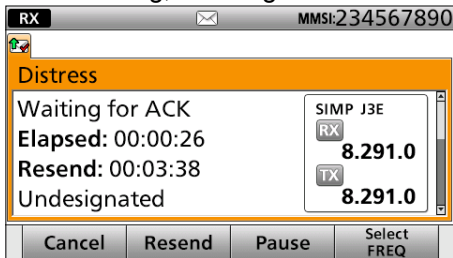

4. When receiving the acknowledgement:
  - Alarm sounds.
  - The following screen is displayed.
 Push any [Alarm Off] .

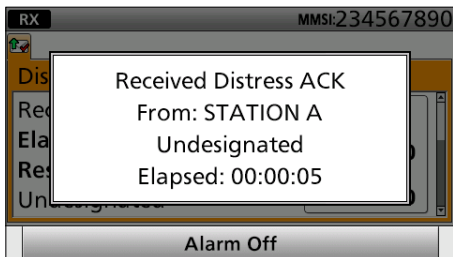

5. Push any [Close Call RCVD Window] .

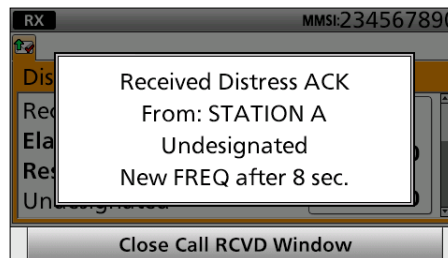

6. Hold down [PTT] to announce your situation.
7. Push [Standby Mode] to return to the Standby mode.

**NOTE:**  
A Distress alert default contains:  
- Nature of distress:  
Undesignated distress  
- Position data:  
The latest GPS or manual input data is held for 23.5 hours, or until turning OFF the transceiver.

■ Sending a Distress call

◇ Regular call

1. Push [Compose Distress]  to display the COMPOSE DISTRESS screen.

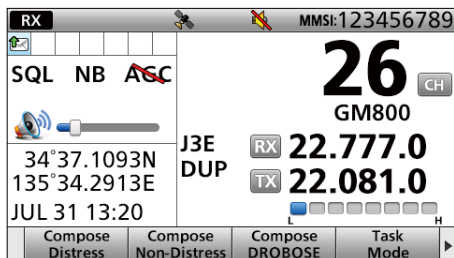

**Step.1 Setting a “Nature of Distress”**

2. Select “Nature of Distress.”

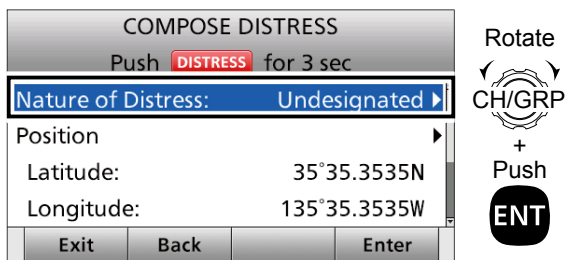

3. Select an option.  
(Example: Fire, Explosion)

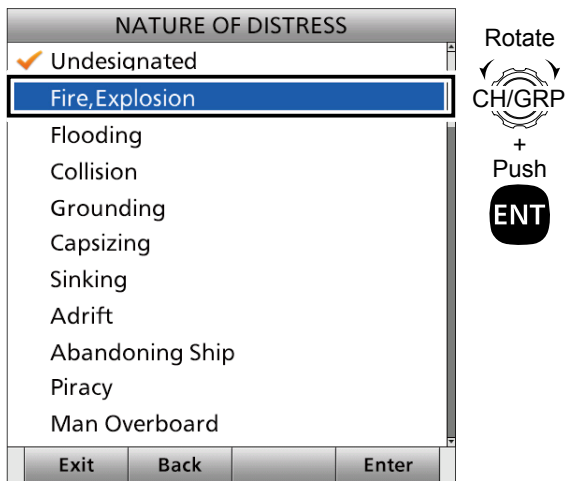

① The transceiver stores this setting for 30 seconds.

**Step 2. Entering a “Position”**

**NOTE:** You can skip this step if your position data and time are valid. In that case, go to Step 3.

4. Select “Position.”
  - The Latitude Position Entry screen is displayed.
5. Enter your position data and time.
  - See page 27 for entering details.

**Step 3. Setting a communication frequency**

6. Select “Attempt.”

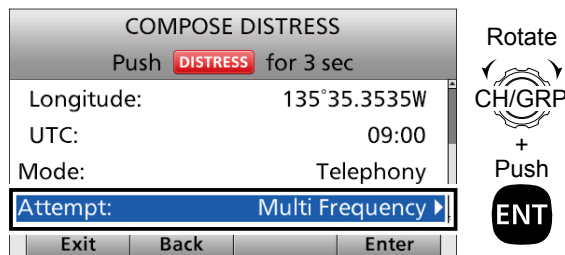

7. Select an option.  
(Example: Multi Frequency)

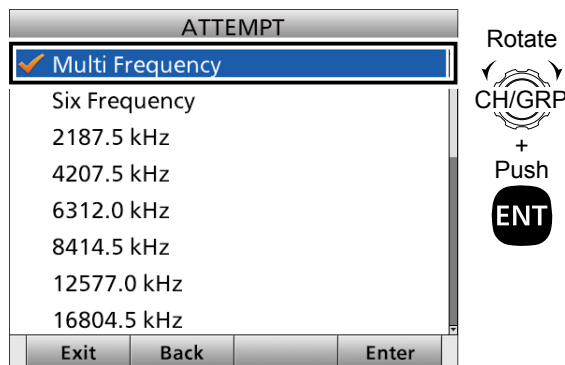

**Step 4. Sending**

8. Lift up the key cover, then hold down [DISTRESS] until “Transmitting” is displayed to send the Distress call.
  - While holding down [DISTRESS], count down beeps sound and both the key and display backlighting blink.

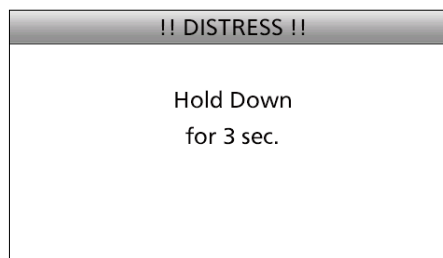

**NOTE:** To cancel a Distress call while transmitting see page 34.

9. After sending, the following screen is displayed.

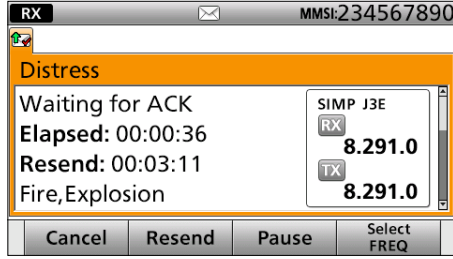

**Step. 5 Replying**

10. When receiving the acknowledgement:

- Alarms sound.
- The following screen is displayed.

Push any [Alarm Off]

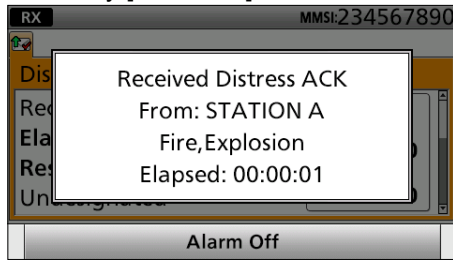

11. Push any [Close Call RCVD Window]

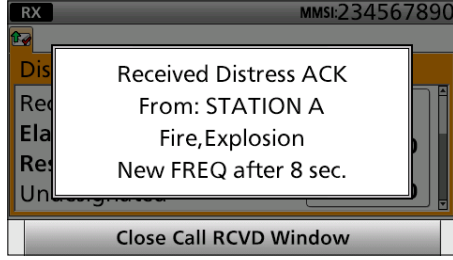

- 12. Hold down [PTT] to announce your situation.
- 13. Push [Standby Mode] to return to the Standby mode.

**NOTE:**

- Transmitting:**
- A Distress call default contains:
    - Nature of distress: Undesignated distress
    - Position data: The latest GPS or manual input position data is retained for 23.5 hours, unless you turn OFF the transceiver.
  - While holding down [DISTRESS], count down beeps sound, and both the key and display backlights blink.
  - The Distress call is transmitted in one of the DSC Emergency frequencies.

**Waiting for an Acknowledgement:**

- The Distress call is automatically transmitted every 3.5 to 4.5 minutes, until an acknowledgement is received (Call Repeat function), or you make a Distress Cancel call. (p. 35)
- To manually transmit a Distress repeat call, push [Resend] .
- To display the transmitted Distress call information, push [▲] or [▼].
- To pause the Call Repeat function, push [Pause] . To resume it, push [Resume Countdown].

■ Sending a Distress call

◇ Resending a Distress call

While waiting for an acknowledgement, you can resend the call (Repeat call).

1. When “Waiting for ACK” is displayed, push [Resend] .

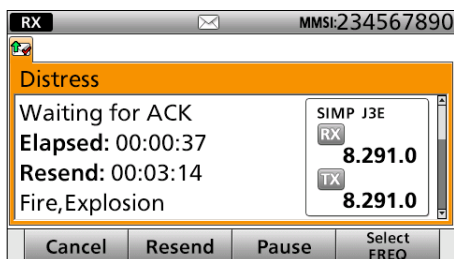

① See page 29 for details of the Software Key functions in the DSC Task mode.

2. Lift up the key cover, then hold down [DISTRESS] until “Retransmitting” is displayed to resend the call.
  - While holding down [DISTRESS], count down beeps sound and both the key and display backlighting blink.



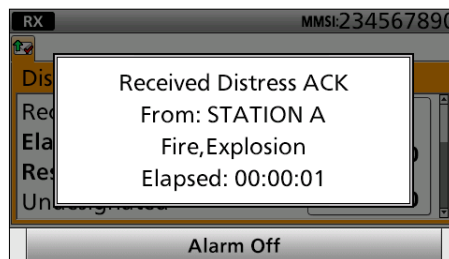

**NOTE:** To cancel a Distress call while transmitting see page 34.

3. When receiving the acknowledgement:
  - Alarms sound.
  - The following screen is displayed.
 Push any [Alarm Off] .

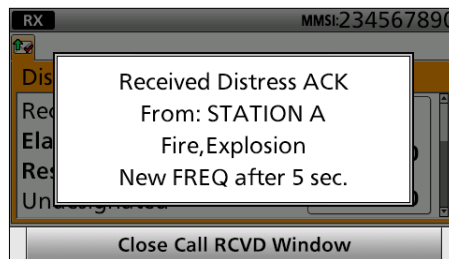

4. Push any [Close Call RCVD Window] .



5. Hold down [PTT] to announce your situation.
6. Push [Standby Mode]  to return to the Standby mode.

### ◇ Sending a Distress Cancel call

You can send the Distress Cancel call while transmitting a Distress call or while waiting for a Distress Acknowledgement.

#### While transmitting a Distress call:

1. While transmitting a Distress call push [Cancel] .



2. Confirm the content and push [Continue] .
  - ① The frequencies that you have to send voice cancel messages are displayed. (Example: 2/4/8/12/16 MHz)

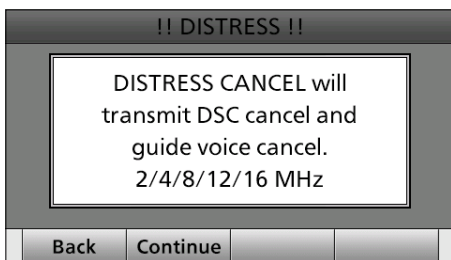

- ① To cancel the Distress Cancel call, push [Back] .



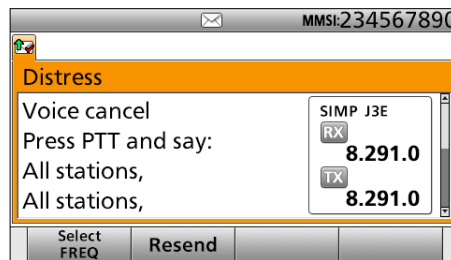

3. After sending, the following screen is displayed. Push [Select FREQ] .

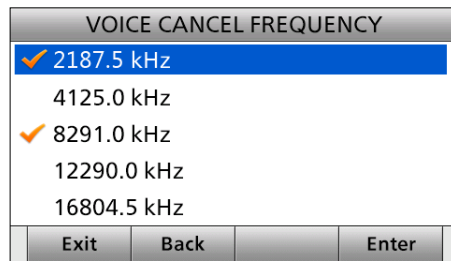

4. Select a frequency to send a voice cancel message and push [ENT].
  - ① The check mark shows that the Distress call on the selected frequency is canceled by sending voice cancel message.



5. Hold down [PTT] to announce your situation.
  - ① You can confirm the statement of the Distress Cancel call by rotating [CH/GRP].
6. Repeat steps 3 to 5 to cancel for all frequencies.
7. After sending a voice cancel message for all frequencies, [Finish]  is displayed. Push [Finish] .

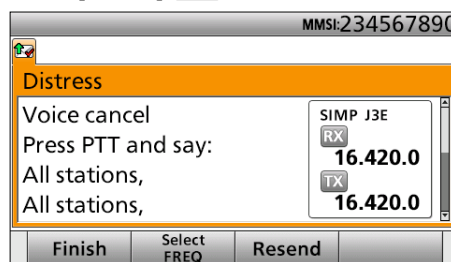

8. Push [Standby Mode]  to return to the Main screen.

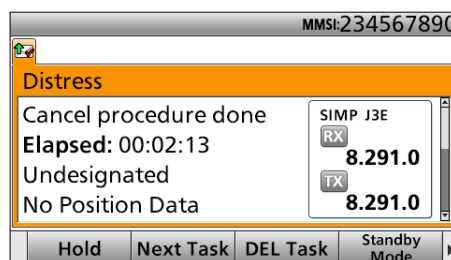

■ Sending a Distress call

◇ Sending a Distress Cancel call (continued)

**While waiting for a Distress Acknowledgement:**

1. When "Waiting for ACK" is displayed, push [Cancel] .

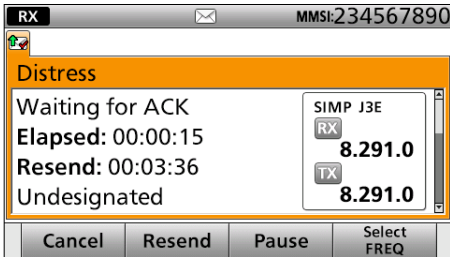

① See page 29 for details of the Software Key functions in the DSC Task mode.

2. Push [Continue]  to send the Distress Cancel call.

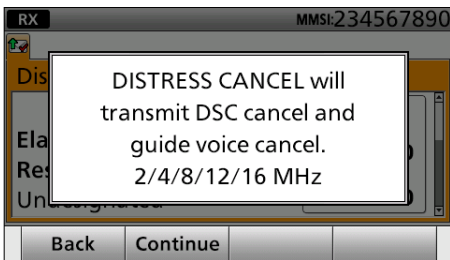

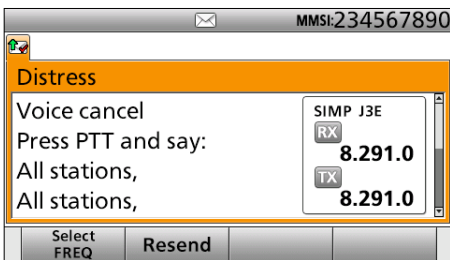

3. After sending, the following screen is displayed. Push [Select FREQ] .



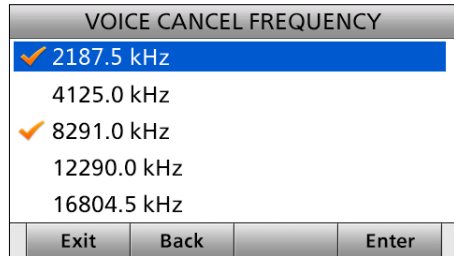

4. Select a frequency to send a voice cancel message and push [ENT].

① The check mark shows that the Distress call on the selected frequency is canceled by sending voice cancel message.

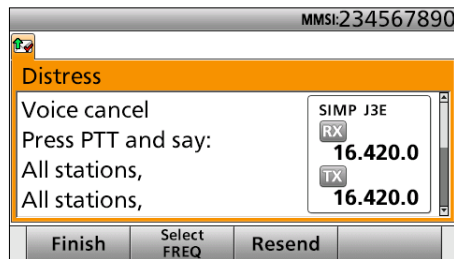

5. Hold down [PTT] to announce your situation.
  - ① You can confirm the statement of the Distress Cancel call by rotating [CH/GRP].
6. Repeat steps 3 to 5 to cancel for all frequencies.
7. After sending a voice cancel message for all frequencies, [Finish]  is displayed. Push [Finish] .



8. Push [Standby Mode]  to return to the Main screen.

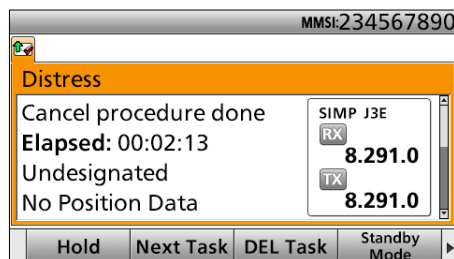



### ◇ Sending a Distress acknowledgement

Distress call reception should stop after one sequence because the coast station should send back an 'acknowledgement' to the ship. If the distress call continues even the coast station send back an 'acknowledgement,' the ship in distress may not be receiving the call. In such cases, you should contact the coast station via the phone and send back an 'acknowledgement' on behalf of the coast station if the coast station requires.

**IMPORTANT:** Distress acknowledgements should be transmitted only on the 2187.5 kHz, according to regulations (ITU-R 493-13). When you receive a Distress call on other frequency bands, [ACK (Distress)] is not displayed in the software key area.

#### Quick ACK:

- When a Distress call is received:
  - Alarm sounds.
  - The following screen is displayed.

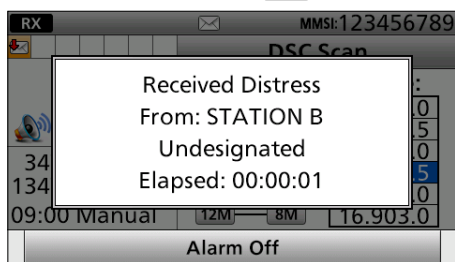

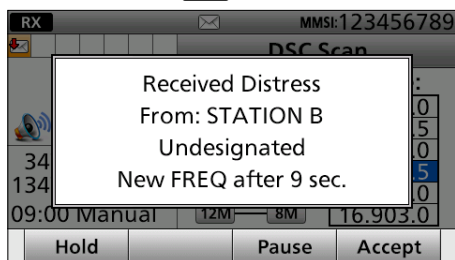

- Push [Accept] .



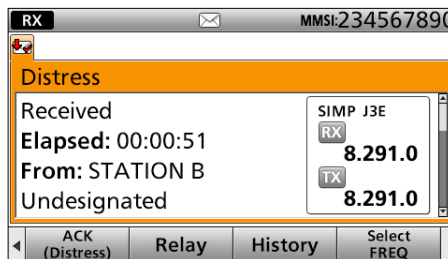

- Enters the DSC Task mode.
- Push [▶▶] to scroll the software key functions.

- Push [ACK (Distress)] .

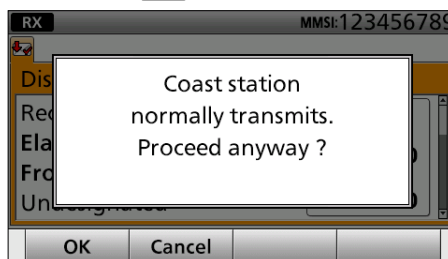

- Push [OK] .



- The DSC call contents screen is displayed.
  - Rotate [CH/ENT] to view the call contents.
- Push [Call]  to send a Distress acknowledgement.

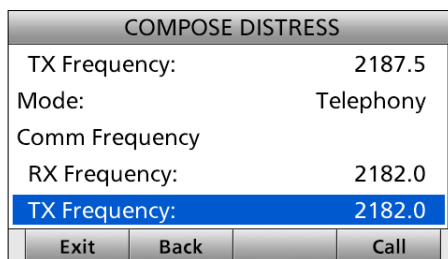

▶ Continued on the next page.

■ Sending a Distress call

◇ Sending a Distress acknowledgement (continued)

7. After sending, the following screen is displayed.

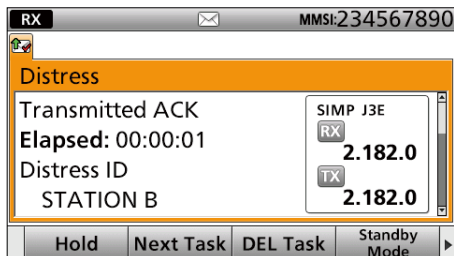

- 8. Hold down [PTT] to communicate with the ship in distress.
- 9. Push [Standby Mode] to return to the Standby mode.

**TIP:** When you push [Pause] in step 2, the countdown will be paused. Push [Resume] to restart the countdown.

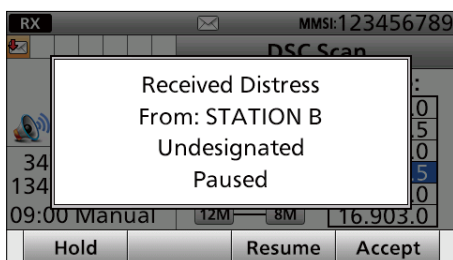

◇ Sending a Distress Relay call

There are 2 ways to transmit the distress relay call—“DROBOSE (Distress Relay On Behalf Of Someone Else)” and “Distress Relay Call with Distress Call Log”.

**NOTE: DO NOT** push [DISTRESS] to transmit a distress relay call. It is used for only your own distress calls.

**To transmit the Distress Relay call with “DROBOSE”:**

You may transmit a Distress Relay call when a ship in distress is in a situation where the Distress call cannot be transmitted, or when you find a ship in distress and quick help is needed.

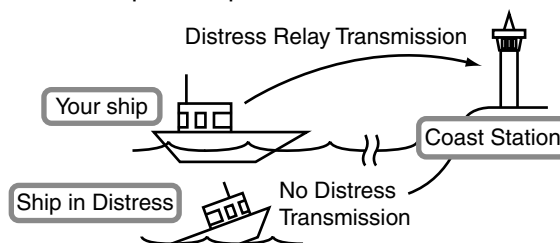

- 1. Push [Compose DROBOSE] .

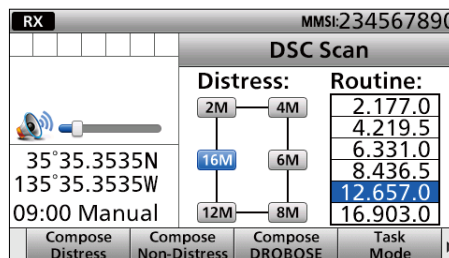

- ① To display the screen from the Menu screen: ([MENU] > **Compose DROBOSE**)

- 2. Select “Message Type.”

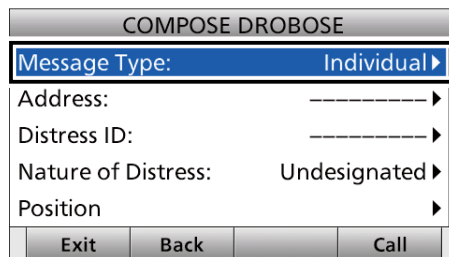

3. Select a message type.  
(Example: Individual)

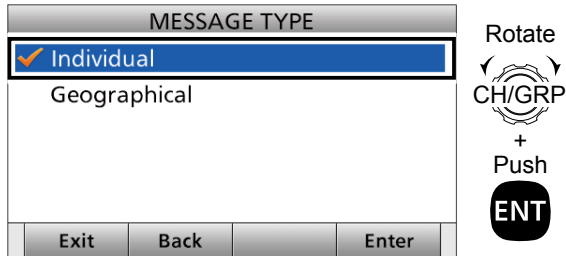

4. Select "Address."

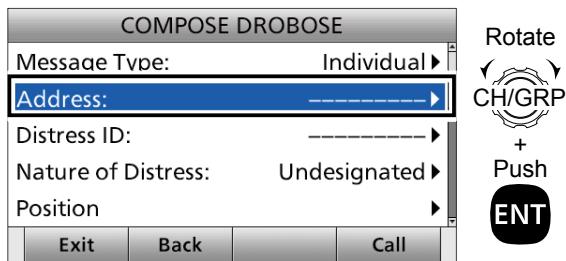

5. Select a coast station address or "Manual Input."  
(Example: COAST A)

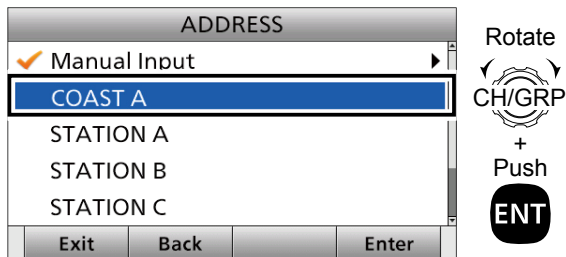

**NOTE:** When you select "Manual Input" in this step, push the keypad to manually enter an Individual ID.

6. Select "Distress ID."

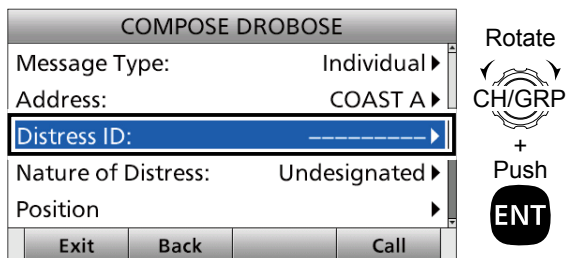

7. Select "Manual Input."

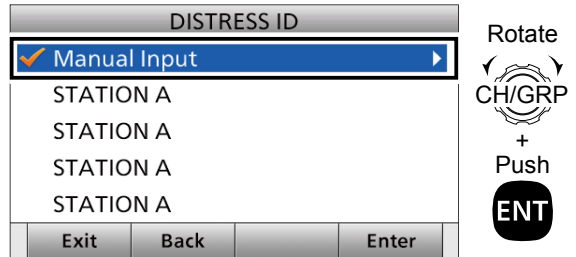

**NOTE:** Distress Call Log is displayed after receiving the Distress call. **DO NOT** select displayed Individual IDs for DROBOSE.

8. Enter the 9 digit Distress ID (MMSI ID) code of the ship in distress that you want to help. After entering, select "Done" and push [ENT].

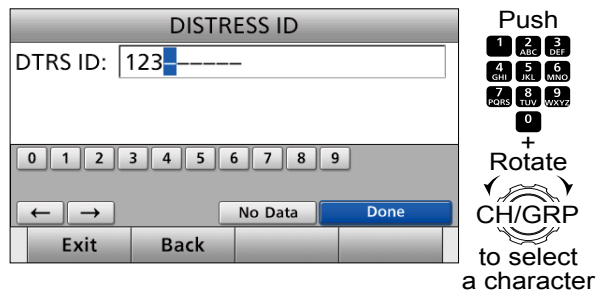

9. Select "Nature of Distress."

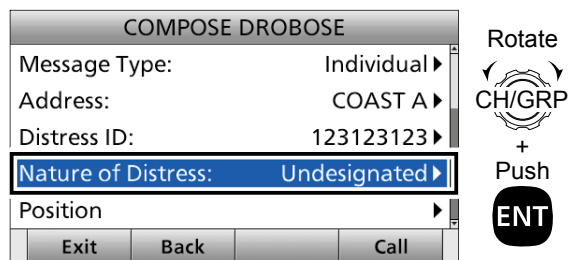

10. Select an option.  
(Example: Fire, Explosion)

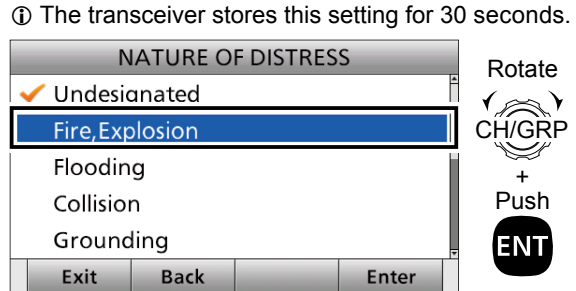

► Continued on the next page.

■ Sending a Distress call

◇ Sending a Distress Relay call (continued)

11. Select "Position."

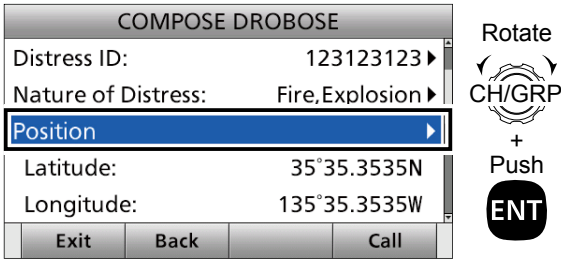

- The Latitude Position Entry screen is displayed.
- Your position data and time are displayed.

12. Enter the position data and time of the ship in distress.

After entering, select "Done" and push [ENT].  
 ① See page 27 for position entering details.

13. Select "Call Frequency."

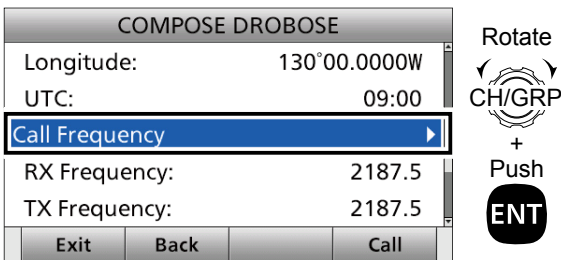

14. Select an option.  
 (Example: 2187.5 kHz)

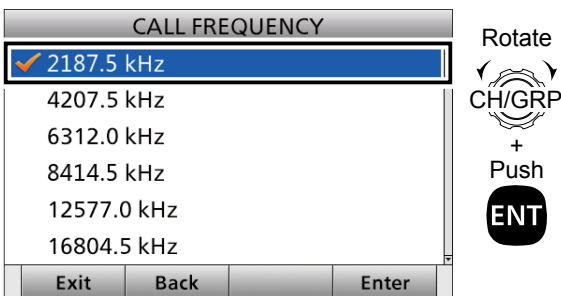

15. Push [Call]  to send the Distress Relay call.

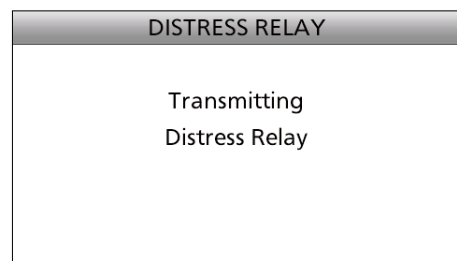
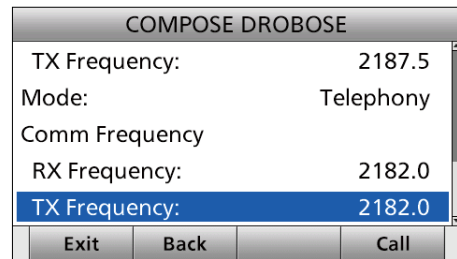

16. After sending, the following screen is displayed.

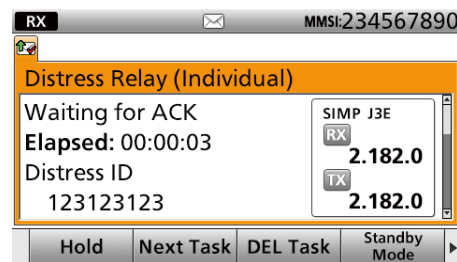

① See page 29 for details of the software key function in the DSC Task mode.

17. Hold down [PTT] to communicate with a maritime station.

18. Push [Standby Mode]  to return to the Standby mode.

**To transmit the Distress Relay call with “Distress Call Log”:**

You can relay a distress call after receiving the distress call.

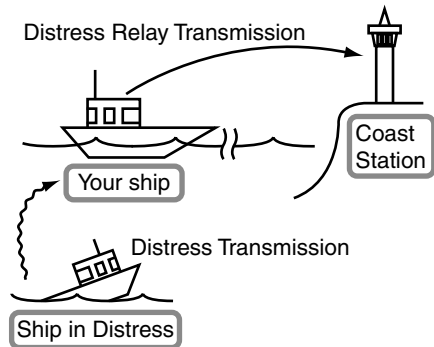

1. Push [Compose DROBOSE]

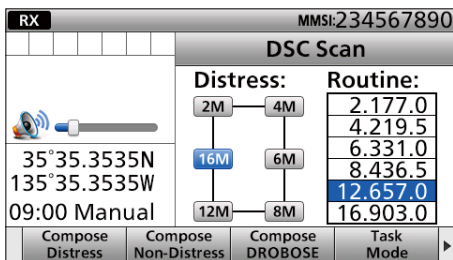

2. Select “Message Type.”

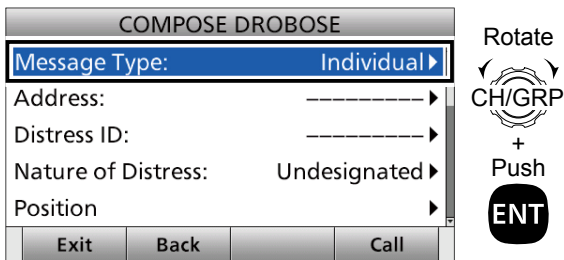

3. Select a message type. (Example: Individual)

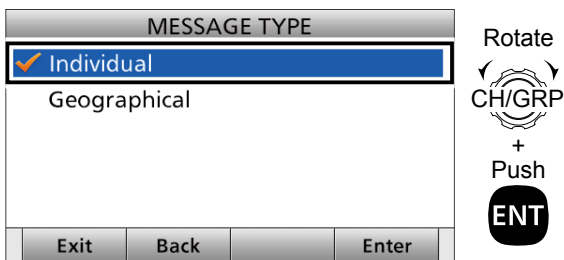

4. Select “Address.”

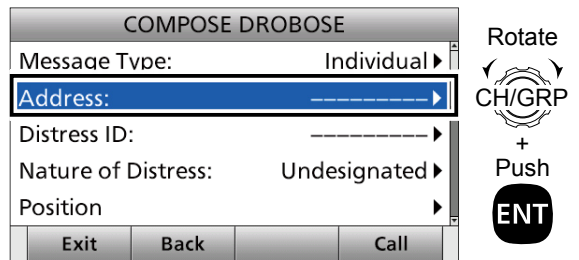

5. Select a coast station address or “Manual Input.” (Example: COAST A)

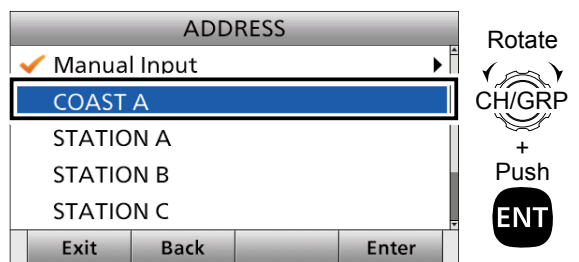

**NOTE:** When you select “Manual Input” in this step, push the keypad to manually enter an Individual ID.

6. Select “Distress ID.”

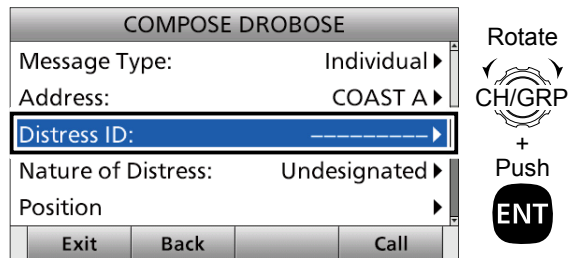

7. Select a Distress ID from the list.   
 ① Distress Call Log is displayed after receiving the Distress Call.

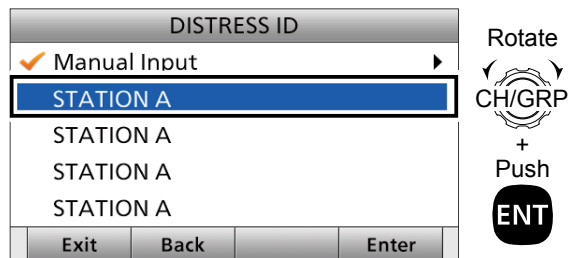

► Continued on the next page.

■ Sending a Distress call

◇ Sending a Distress Relay call (continued)

8. Select "Call Frequency."

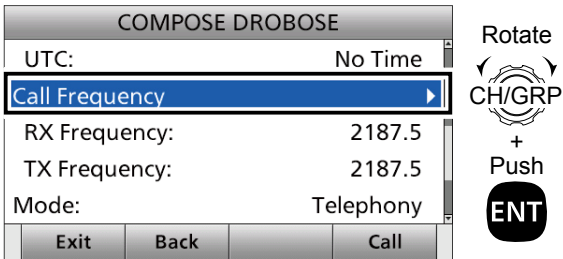

9. Select an option.  
(Example: 2187.5 kHz)

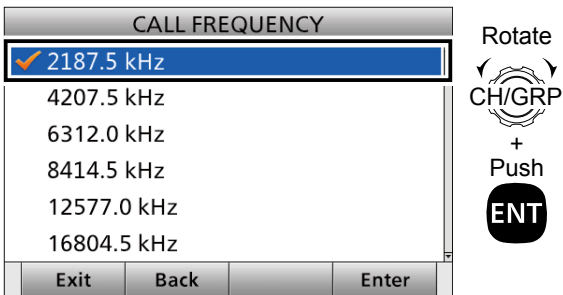

10. Push [Call]  to send the Distress Relay call.

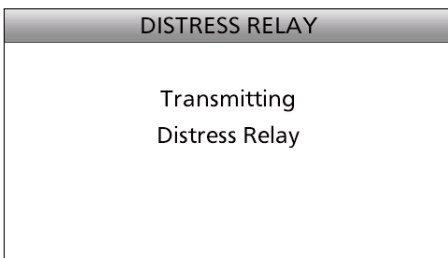
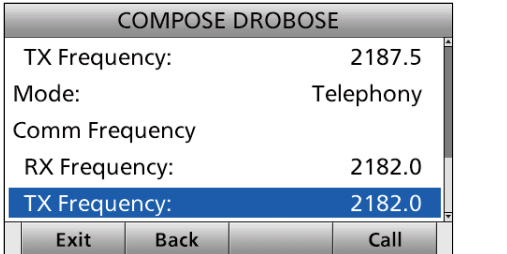

11. After sending, the following screen is displayed.

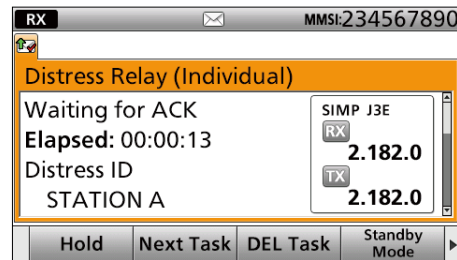

① See page 29 for details of the software key function in the DSC Task mode.

12. Hold down [PTT] to communicate with a coast station.

13. Push [Standby Mode]  to return to the Standby mode.

### ◇ Sending a Distress Relay acknowledgement

Only when the Distress Relay call is received, you can send the Distress Relay acknowledgement.

#### Quick ACK:

- When a Distress Relay call is received:
  - Alarm sounds.
  - The following screen is displayed.



- Push [Accept] .
  - Enters the DSC Task mode.
  - “✓” is displayed on the Task tab.

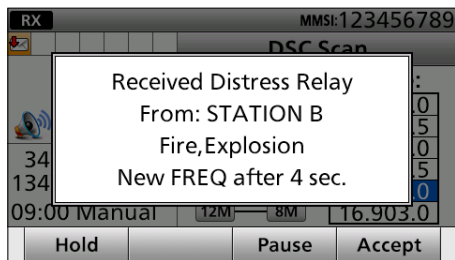

- Push [▶] to scroll the software key function.
- Push [ACK (Relay)] .
  - The call contents screen is displayed.

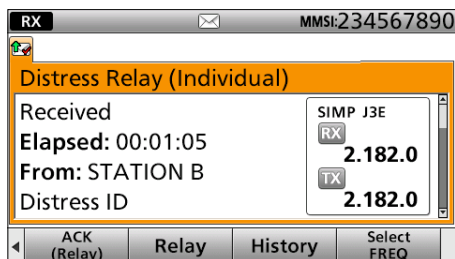

- The call contents screen is displayed.
- ① Rotate [CH/ENT] to view the call contents.

- Push [Call] to send the Distress Relay acknowledgement.

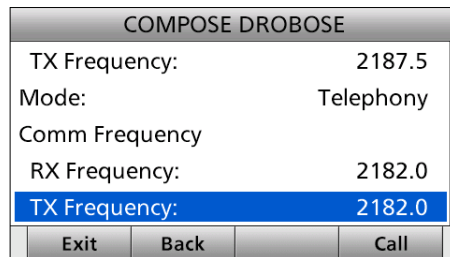

- After sending, the following screen is displayed.

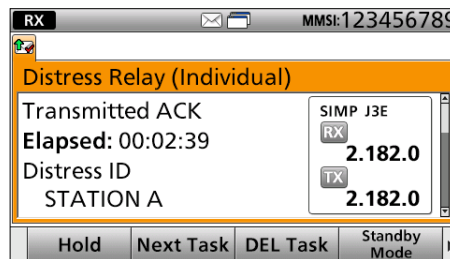

- Hold down [PTT] to communicate with the ship in distress.
- Push [Standby Mode] to return to the Standby mode.

**TIP:** When you push [Pause] in step 2, the countdown will be paused. Push [Resume] to restart the countdown.

## ■ Sending a Non-Distress calls

### ◇ Sending an Individual call

The Individual call function enables you to transmit a DSC signal to only a specific coast station or ship. After transmission, wait for an acknowledgement from the receiving station.

You can communicate by voice after receiving the acknowledgement 'ACK (able).'

1. Push [Compose Non-Distress] .

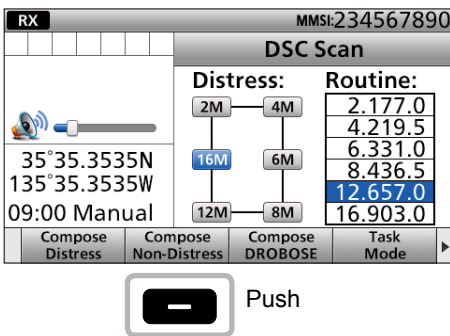

① To display the screen from the Menu screen:  
([MENU] > **Compose Non-Distress**)

2. Select "Address."

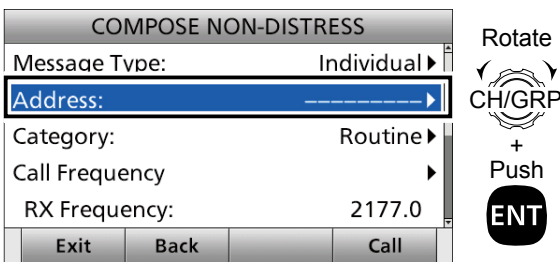

3. Select an Individual address, or "Manual Input." (Example: STATION A)

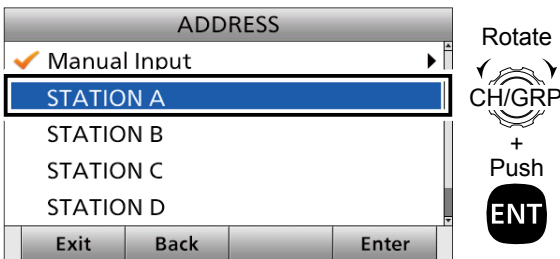

**NOTE:** When you select "Manual Input" in this step, push the keypad to manually enter an Individual ID.

4. Select "Category."

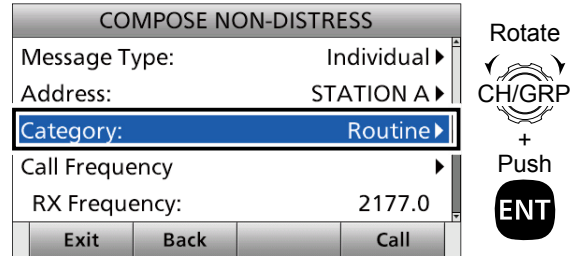

5. Select an option. (Example: Routine)

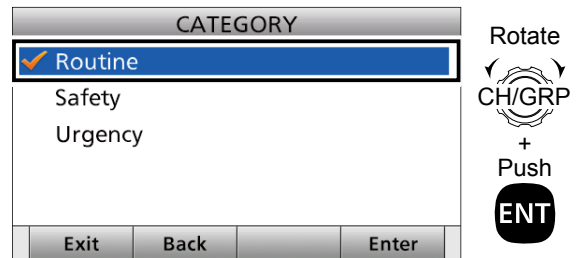

#### ① Information

When you have manually entered an Individual ID, push the keypad to select the DSC call frequency.

1. Select "Call Frequency."

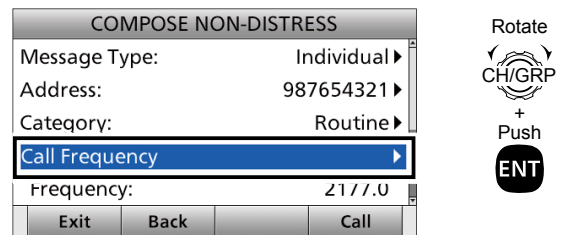

2. Select a DSC call frequency, or "Manual Input." (Example: INTER2-1)

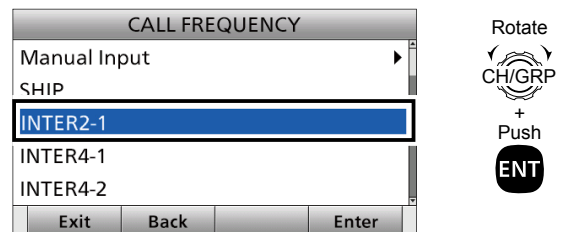

**NOTE:** When you select "Manual Input" in this step, push the keypad to manually enter the DSC call frequency.



6. Select "Comm Frequency."

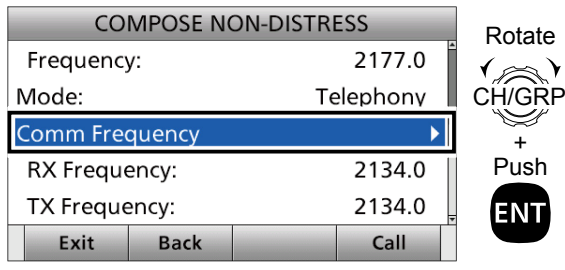

7. Select a communication frequency, or "Manual Input."  
(Example: SHIP 2M)

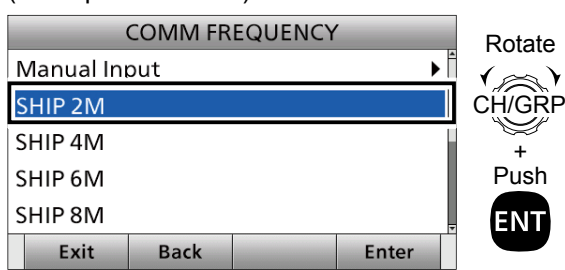

**NOTE:** When you select "Manual Input" in this step, push the keypad to manually enter a communication frequency.

8. Send an Individual call.

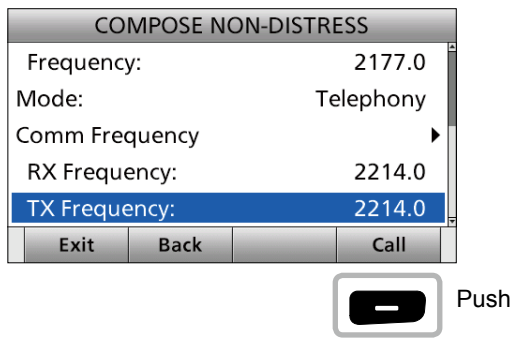

9. After sending, "Waiting for ACK" is displayed.

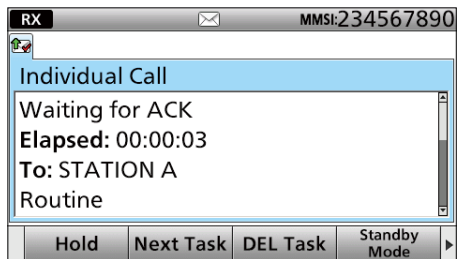

10. When receiving the acknowledgement:

- Alarm sounds.
  - The following window is displayed.  
(Example: ACK (Able))
- Push any [Alarm Off]

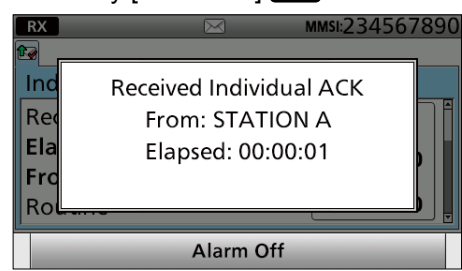

- 11. Push any [Close Call RCVD Window] .
- 12. Hold down [PTT] to communicate.
- 13. Push [Standby Mode] to return to the Standby mode.

■ Sending a Non-Distress calls

◇ Sending an Individual acknowledgement

When receiving an Individual call, you can send an acknowledgement ('Able,' 'Unable,' or 'New CH') by using the on-screen prompts.

- When an Individual call is received:
  - Alarm sounds.
  - The following screen is displayed.

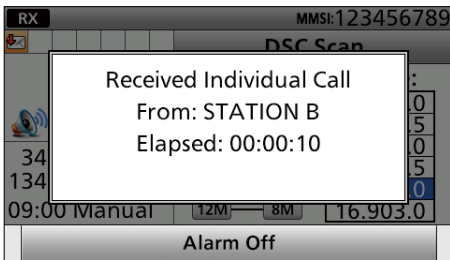

- Push [Accept]

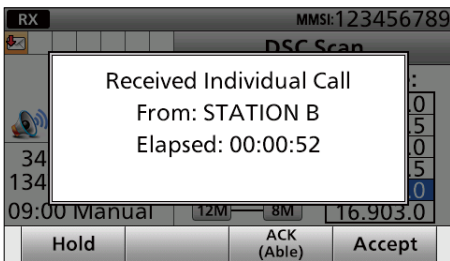

- Enters the DSC Task mode.
- “✓” is displayed on the Task tab.

- Push [▶] to scroll the software key function.
- Push a key to select an acknowledgement option. (Example: ACK (Able))

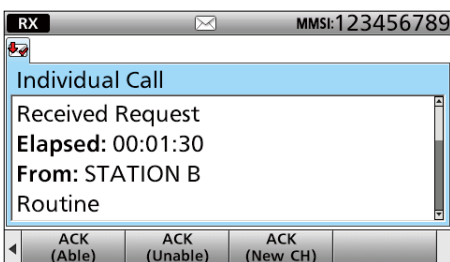

① Information

**ACK (Able):**  
Send an acknowledgment without any changes.  
**ACK (Unable):**  
Send an acknowledgment, but you cannot make a communication.  
**ACK (New CH):**  
Send an acknowledgment. You can specify the Voice Communication channel.

- Rotate [CH/GRP] to confirm the contents.
- Push [Call] to send the Individual acknowledgement.
- Hold down [PTT] to communicate.
- Push [Exit] to return to the Main screen.

◇ Sending a Group call

You can transmit a DSC signal to only a specific group.

- Push [Compose Non-Distress] .

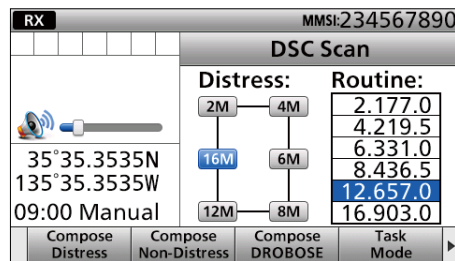

- To display the screen from the Menu screen: ([MENU] > **Compose Non-Distress**)

- Select “Message Type.”

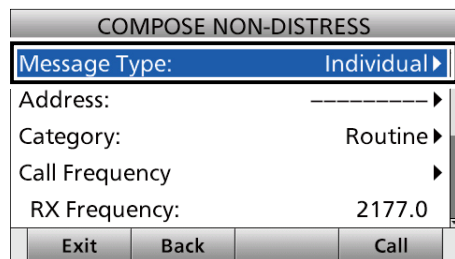

- Select “Group.”

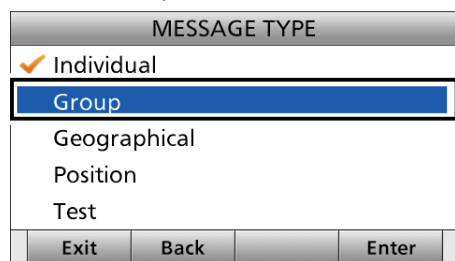

- Select “Address.”

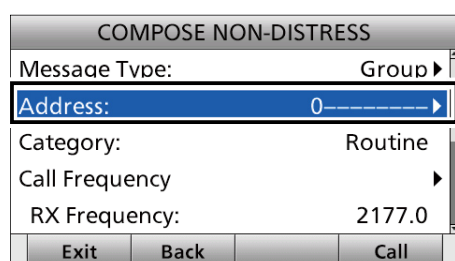

- The call contents screen is displayed.

5. Select a Group ID, or "Manual Input."  
(Example: GROUP 1)

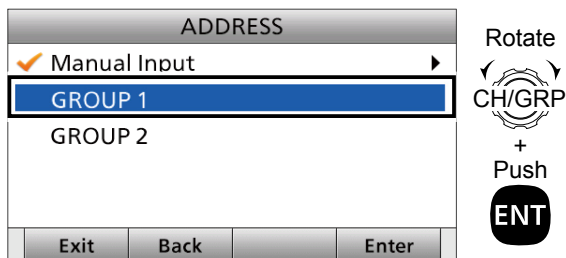

**NOTE:** When you select "Manual Input" in this step, push the keypad to manually enter a Group ID.

**Information**

- The "Category" is fixed to "Routine."
- When you have manually entered a Group ID, push the keypad to manually select the DSC call frequency.

1. Select "Call Frequency."

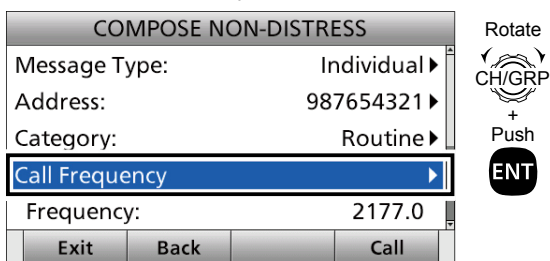

2. Select a DSC call frequency, or "Manual Input."  
(Example: INTER2-1)

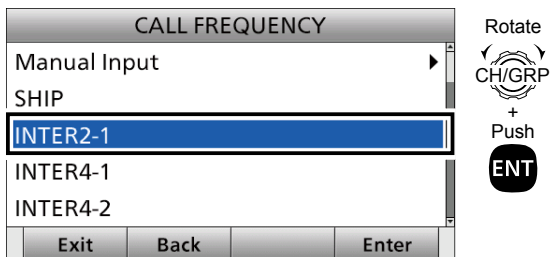

**NOTE:** When you select "Manual Input" in this step, push the keypad to manually enter the DSC call frequency.

6. Select "Comm Frequency."

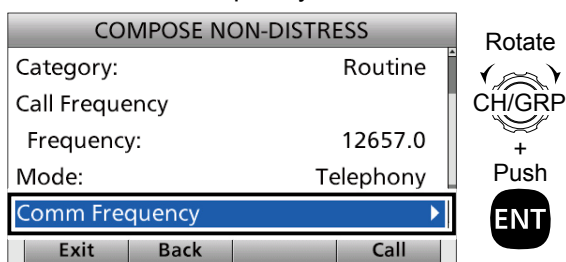

7. Select a communication frequency, or "Manual Input."  
(Example: SHIP 2M)

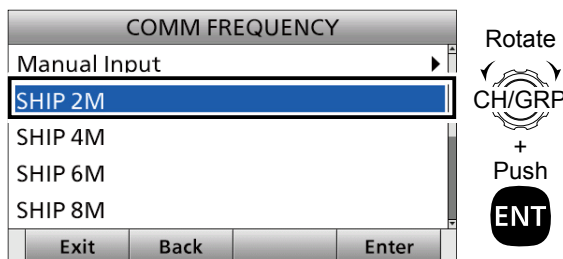

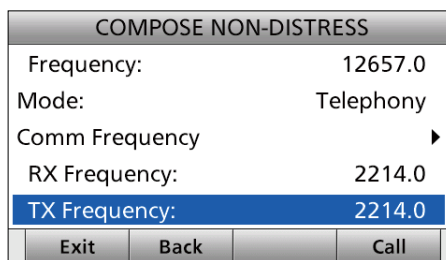

**NOTE:** When you select "Manual Input" in this step, push the keypad to manually enter a communication frequency.

8. Push [Call]  to send the Group call.

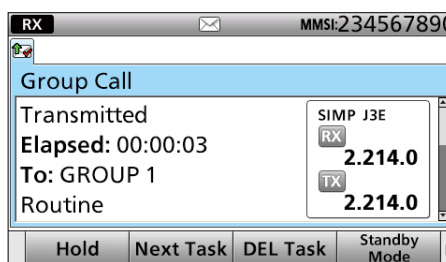

9. After sending, the following screen is displayed.  
① See page 29 for details of the software key functions in the DSC Task mode.



10. Hold down [PTT] to communicate.
11. Push [Standby Mode]  to return to the Standby mode.

■ Sending a Non-Distress calls

◇ Sending a Geographical call

Send a Geographical call when urgency or safety message announcement is necessary to the ships in the particular area.

1. Push [Compose Non-Distress] .

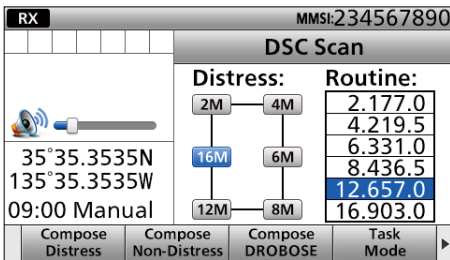

- ① To display the screen from the Menu screen:  
([MENU] > **Compose Non-Distress**)

2. Select "Message Type."

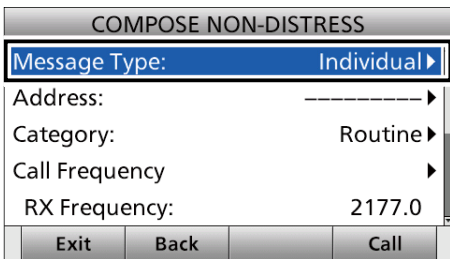

3. Select "Geographical."

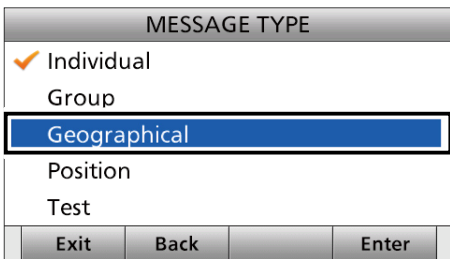

4. Select "Area."

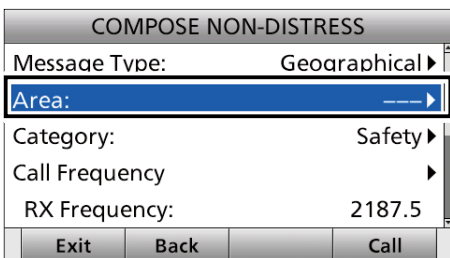

5. Select "Circle" or "Quadrant."

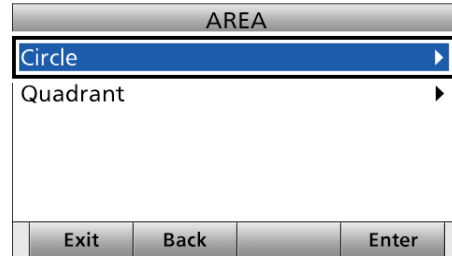

6. Enter the area information.

**When selecting "Circle":**

You can send a Geographical call within the area covered by a set nautical mile radius from your position.

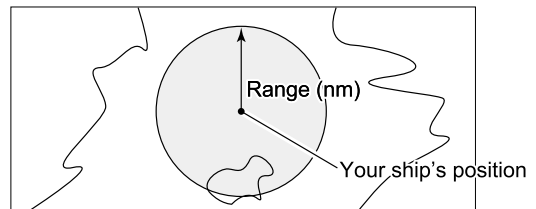

1. Enter the latitude of your position. After entering, select "Done" and push [ENT].  
① Displays your ship's position as default.

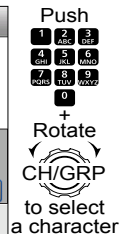
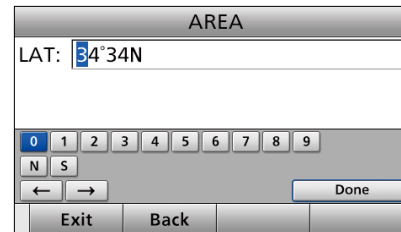

2. Enter the longitude of your position. After entering, select "Done" and push [ENT].  
① Displays your ship's position as default.

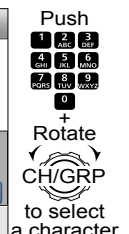
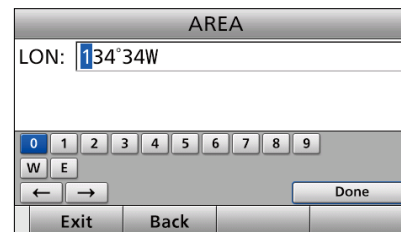

**3** Enter the radius of the Geographical call area. After entering, select "Done" and push [ENT]. (Example: 500 nm)

Push + Rotate CH/GRP to select a character

**3** Enter the height of the Geographical call area. After entering, select "Done" and push [ENT].

Push + Rotate CH/GRP to select a character

**4** Enter the width of the Geographical call area. After entering, select "Done" and push [ENT].

Push + Rotate CH/GRP to select a character

**When selecting "Quadrant":**  
 You can send a Geographical call within the square area as shown below. Your position is the upper left corner of the square.

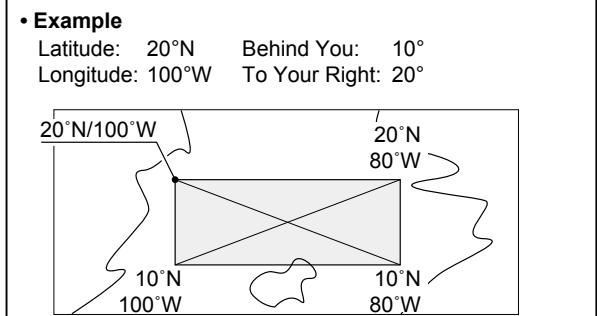

**1** Enter the latitude of your position. After entering, select "Done" and push [ENT].

Push + Rotate CH/GRP to select a character

**2** Enter the longitude of your position. After entering, select "Done" and push [ENT].

Push + Rotate CH/GRP to select a character

**7.** Select "Category."  
 ⓘ The displayed items may differ depending on the selected option in "Area."

Rotate CH/GRP + Push

**8.** Select an option. (Example: Safety)

Rotate CH/GRP + Push

▶ Continued on the next page.

■ Sending a Non-Distress calls

◇ Sending a Geographical call (continued)

9. Select “Call Frequency.”

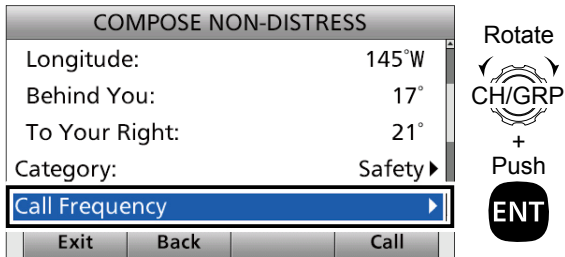

10. Select an option. (Example: 8414.5 kHz)

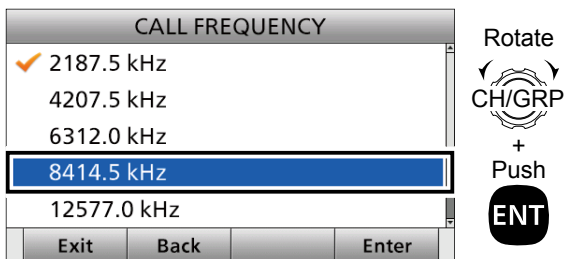

11. Select “Comm Frequency.”

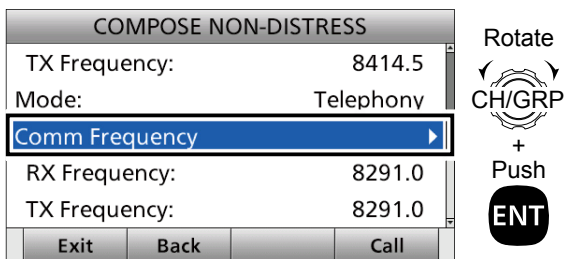

12. Select a communication frequency, or “Manual Input.”

(Example: SHIP 6M)

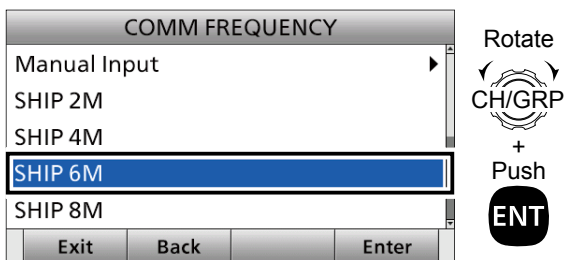

**NOTE:** When you select “Manual Input” in this step, push the keypad to manually enter a communication frequency.

13. Push [Call]  to send the Geographical call.

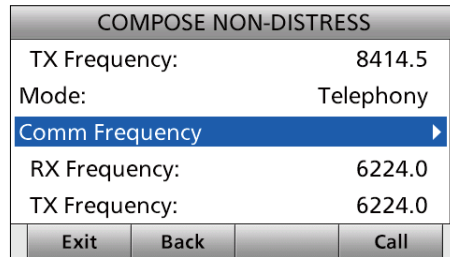

14. After sending, the following screen is displayed.  
① See page 29 for details of the software key functions in the DSC Task mode.

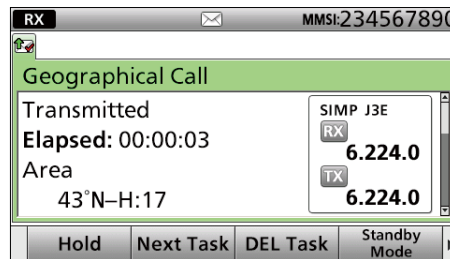

15. Hold down [PTT] to communicate.

16. Push [Standby Mode]  to return to the Standby mode.

### ◇ Sending a Position Request call

Send a Position Request call when you want to know a specific ship's current position, and so on.

1. Push [Compose Non-Distress] .

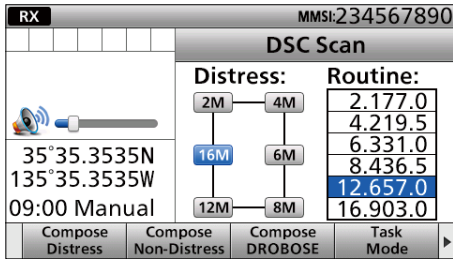

① To display the screen from the Menu screen:  
([MENU] > **Compose Non-Distress**)

2. Select "Message Type."

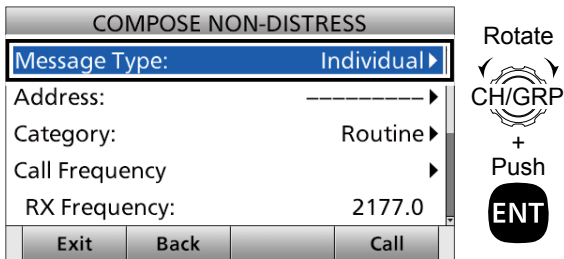

3. Select "Position."

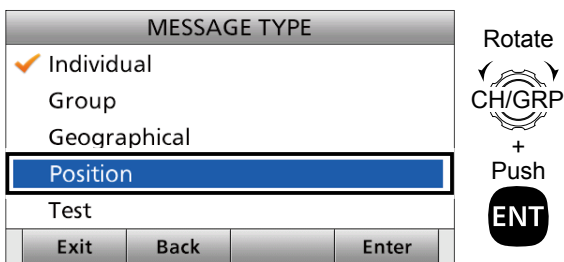

4. Select "Address."

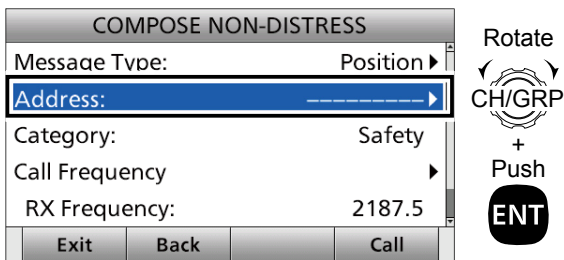

5. Select an Individual ID, or "Manual Input." (Example: STATION A)

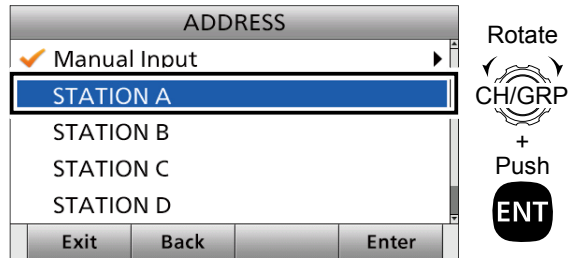

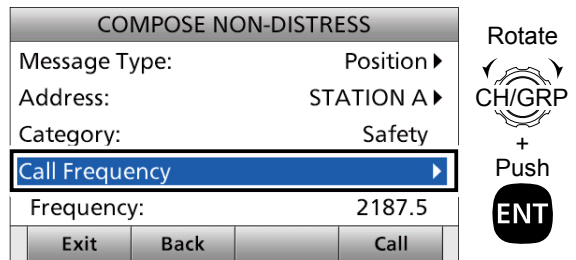

**NOTE:** When you select "Manual Input" in this step, push the keypad to manually enter an Individual ID.

6. Select "Call Frequency."

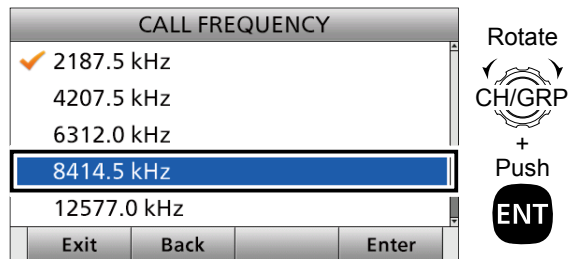

7. Select an option. (Example: 8414.5 kHz)



8. Push [Call]  to send the Position Request call.

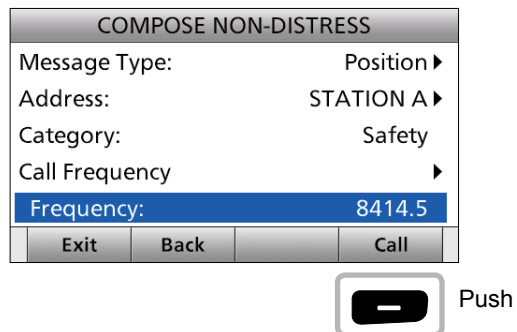



► Continued on the next page.

■ Sending a Non-Distress calls

◇ Sending a Position Request call (continued)

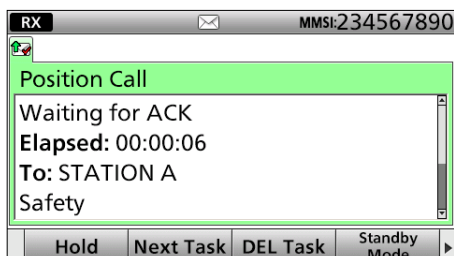
- After sending, the following screen is displayed.
  - See page 29 for details of the software key function in the DSC Task mode.



- Push [Standby Mode]  to return to the Standby mode.

◇ Sending a Position Request acknowledgement

When receiving a Position Request call, you can send an acknowledgement.

- When a Position Request call is received:
  - Alarm sounds.
  - The following screen is displayed.
 Push any [Alarm Off] .

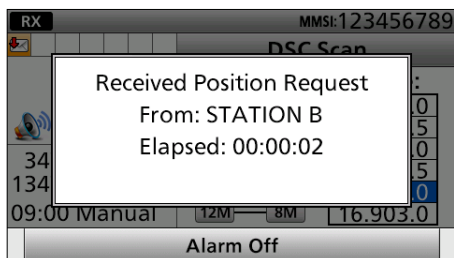

- Push [Accept] .

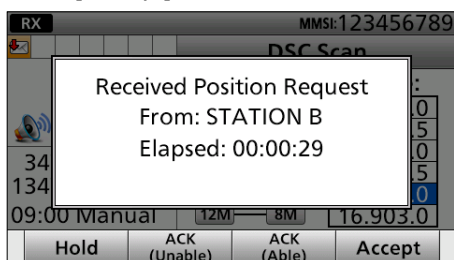

- Enters the DSC Task mode.
  - “✓” is displayed on the Task tab.
- Push [▶] to scroll the software key function.

- Push a key to select an acknowledgement option. (Example: ACK (Able))

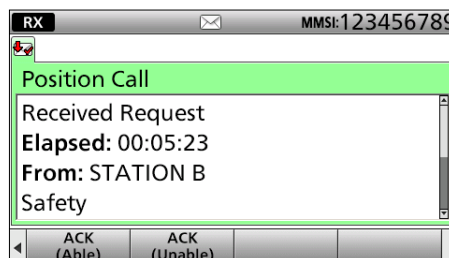

① Information

**ACK (Able):**

Send an acknowledgment with position data and time.

**ACK (Unable):**

Send an acknowledgment, but it does not include position data.

- The call contents screen is displayed.
  - Rotate [CH/GRP] to confirm the contents.
  - Change your position data, if the displayed data is invalid. (p. 27)

- Push [Call]  to send the Position Request acknowledgement.

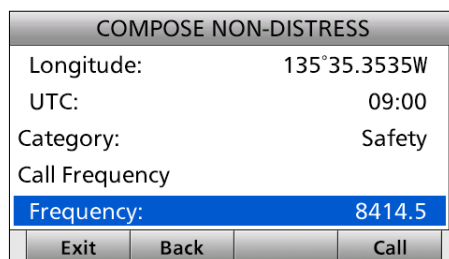

- Your position data and time are transmitted.
- Push [Standby Mode]  to return to the Standby mode.

**TIP:** When “Position ACK” is set to Auto, the transceiver automatically replies to the call. (p. 71)



### ◇ Sending a Polling Request acknowledgement

When a Polling Request is received, you can send an acknowledgement.

- When a Polling Request call is received:
  - Alarm sounds.
  - The following screen is displayed.

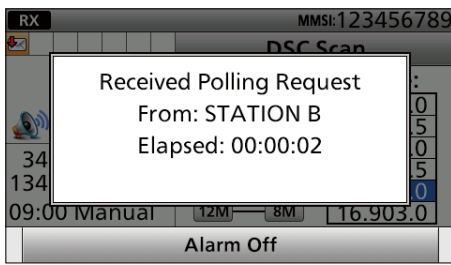

- Push [Accept]

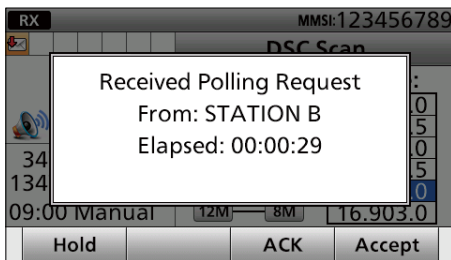

• Enters the DSC Task mode.

- Push [▶] to scroll the software key function.
- Push [ACK]

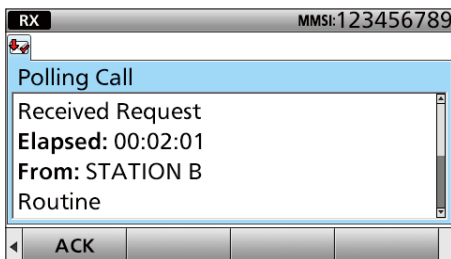

- The call contents screen is displayed.
- Rotate [CH/GRP] to confirm the contents.

- Push [Call] to send the Polling Request acknowledgement.

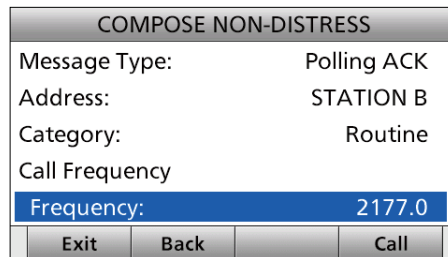

• Your position data and time are transmitted.

- Push [Standby Mode] to return to the Standby mode.

### ◇ Sending a Test call

Testing on the exclusive DSC Distress and Safety calling frequencies should be avoided as much as possible by using other methods. Normally the test call would require no further communications between the 2 stations involved.

- Push [Compose Non-Distress]

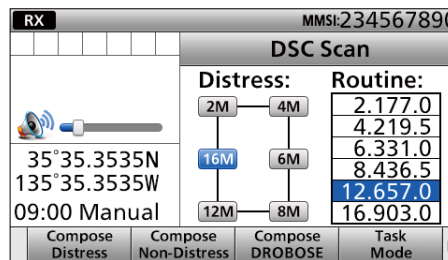

① To display the screen from the Menu screen: ([MENU] > **Compose Non-Distress**)

- Select "Message Type."

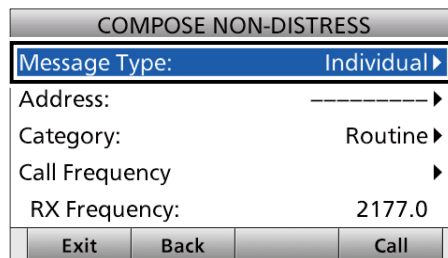

▶ Continued on the next page.

■ Sending a Non-Distress calls

◇ Sending a Test call (continued)

3. Select "Test."

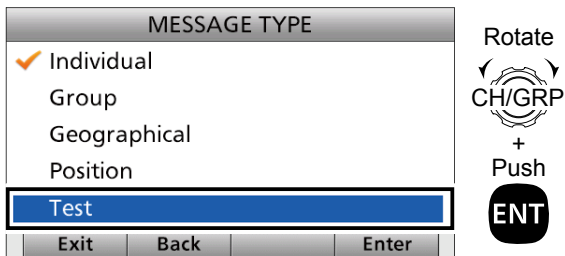

4. Select "Address."

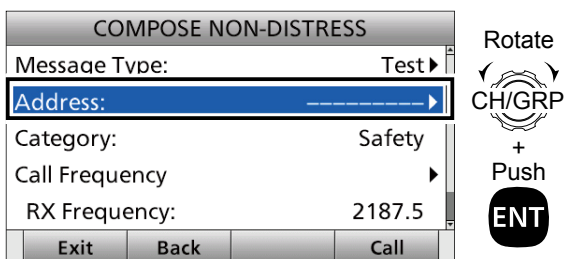

5. Select an Individual ID, or "Manual Input." (Example: STATION A)

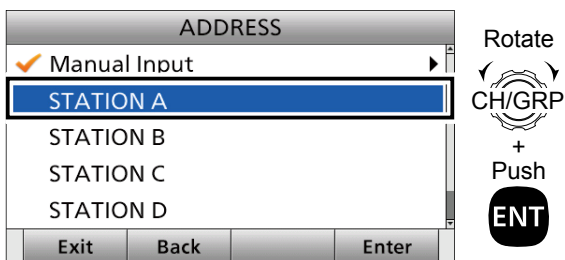

**NOTE:** When you select "Manual Input" in this step, push the keypad to manually enter an Individual ID.

6. Select "Call Frequency."

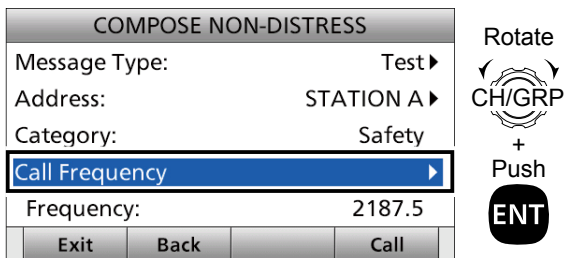

7. Select an option. (Example: 8414.5 kHz)

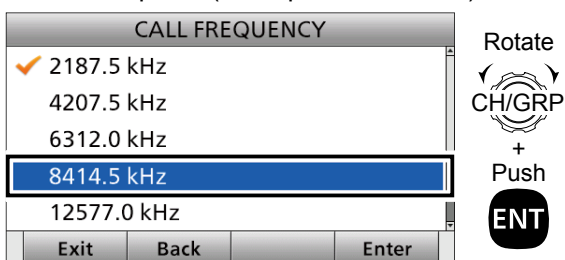

8. Push [Call] to send the Test call.

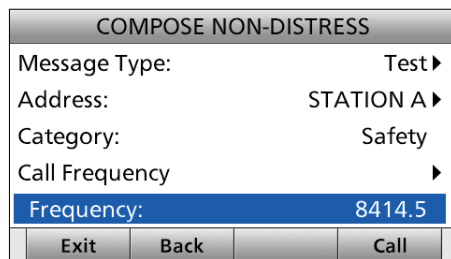

9. After sending, the following screen is displayed.

① See page 29 for details of the software key function in the DSC Task mode.

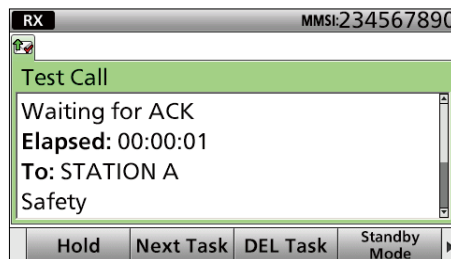

10. Push [Standby Mode] to return to the Standby mode.

◇ Sending a Test call acknowledgement

When a Test call is received, you can send an acknowledgement.

- When a Test call is received:
  - Alarm sounds.
  - The following screen is displayed.

Push any [Alarm Off] .

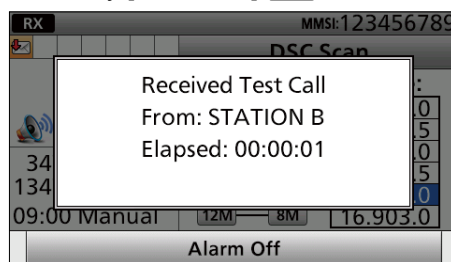

2. Push [Accept] .

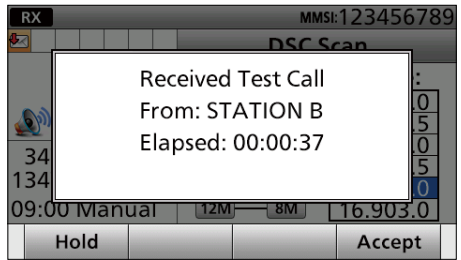

- Enters the DSC Task mode.

3. Push [▶] to scroll the software key function.
4. Push [ACK] .

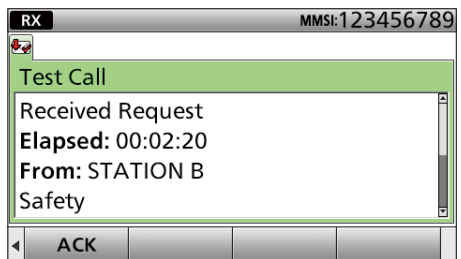

- The call contents screen is displayed.
- Rotate [CH/GRP] to confirm the contents.

5. Push [Call]  to send the Test call acknowledgement.

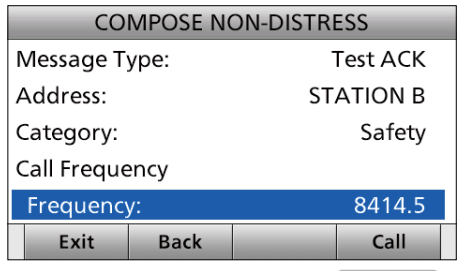

6. Push [Standby Mode]  to return to the Standby mode.

**TIP:** When “Test ACK” is set to Auto, the transceiver automatically replies to the call. (p. 71)

### ◇ Sending a Medical Transports call or Ships and Aircraft call

The Medical Transports call informs all ships, by urgency priority, that your ship is carrying a patient in need of medical treatment.

The Ships and Aircraft call informs all ships that your ship is a neutral (not a participant) in armed conflict. Be sure to send the call **BEFORE** entering an area of armed conflict.

**NOTE:** You should set the “Medical Transports” or “Ships and Aircraft” item to ON in advance. (p. 72)

1. Push [Compose Non-Distress] .

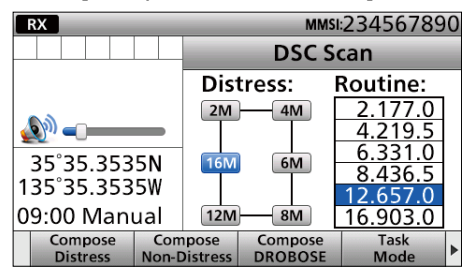

① To display the screen from the Menu screen: ([MENU] > **Compose Non-Distress**)

2. Select “Message Type.”

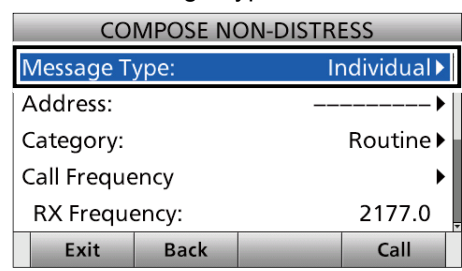

3. Select “Medical Transports” or “Ships and Aircraft.” (Example: Medical Transports)

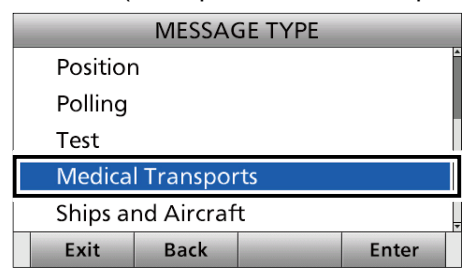

► Continued on the next page.

■ Sending a Non-Distress calls

◇ Sending a Medical Transports call or Ships and Aircraft call (continued)

4. Select "Area."

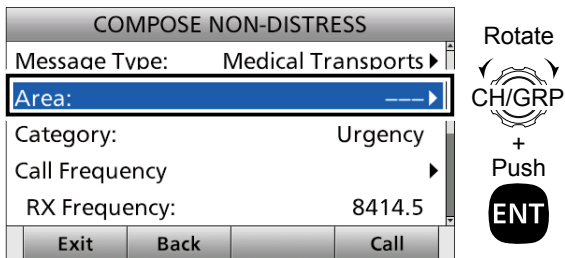

5. Select "Circle" or "Quadrant."

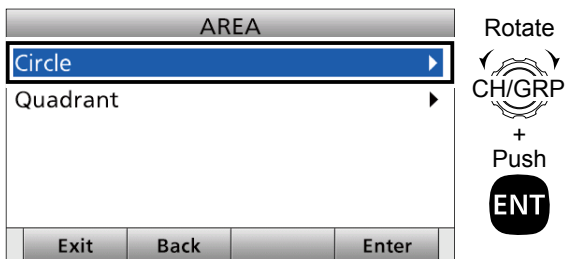

6. Enter the area information.

**When selecting "Circle":**

You can send a Medical Transports call or Ships and Aircraft call within the area covered by a set nautical mile radius from your position.

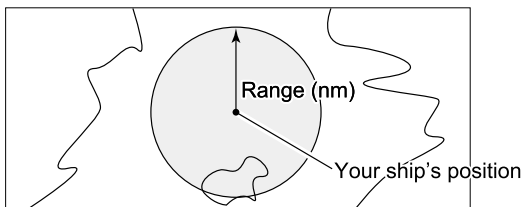

1 Enter the latitude of your position. After entering, select "Done" and push [ENT].  
 ① Displays your ship's position as default.

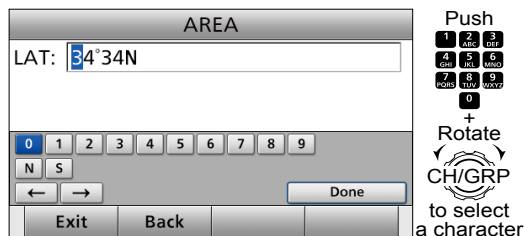

2 Enter the longitude of your position. After entering, select "Done" and push [ENT].  
 ① Displays your ship's position as default.

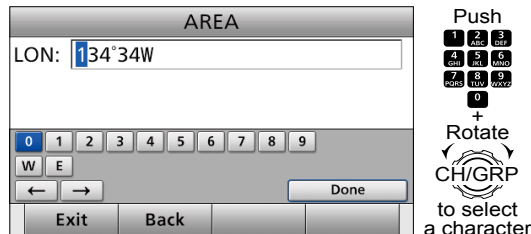

3 Enter the radius of the Medical Transports call or Ships and Aircraft call area. After entering, select "Done" and push [ENT].  
 (Example: 500 nm)

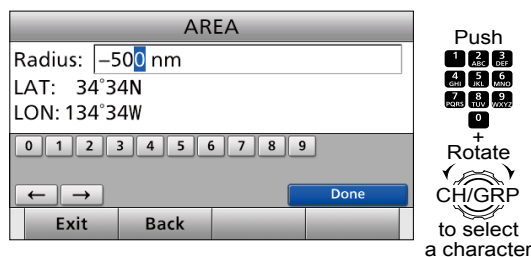

**When selecting "Quadrant":**

You can send a Medical Transports call or Ships and Aircraft call within the square area as shown below. Your position is the upper left corner of the square.

• Example

Latitude: 20°N Behind You: 10°  
 Longitude: 100°W To Your Right: 20°

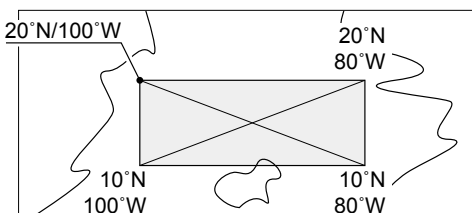

1 Enter the latitude of your position. After entering, select "Done" and push [ENT].

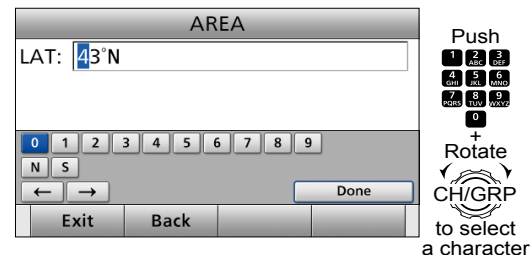

2 Enter the longitude of your position. After entering, select "Done" and push [ENT].

3 Enter the height of the Medical Transports call area. After entering, select "Done" and push [ENT].

4 Enter the width of the Medical Transports call area. After entering, select "Done" and push [ENT].

Push [1-9] + Rotate CH/GRP to select a character

9. Select "Comm Frequency."

Rotate CH/GRP + Push [ENT]

10. Select a communication frequency, or "Manual Input." (Example: SHIP 8M)

Rotate CH/GRP + Push [ENT]

**NOTE:** When you select "Manual Input" in this step, push the keypad to manually enter a communication frequency.

11. Push [Call] to send the Medical Transports or Ships and Aircraft call. (Example: Medical Transports call)

Push [Call]

7. Select "Call Frequency."

Rotate CH/GRP + Push [ENT]

8. Select an option. (Example: 8414.5 kHz)

Rotate CH/GRP + Push [ENT]

12. After sending, the following screen is displayed. See page 29 for details of the software key functions in the DSC Task mode.

13. Hold down [PTT] to communicate.  
14. Push [Standby Mode] to return to the Standby mode.

## Receiving DSC calls

**NOTE: After receiving a DSC call**

- “” is continuously displayed when the transceiver has DSC calls.
- “” continuously blinks when the transceiver has an unread DSC message in the Received Call Log. (p. 69)

**IMPORTANT:**

You should stop Distress call reception after one sequence because the coast station should send back an acknowledgement to the ship. If the Distress call continues, the coast station may not be receiving the call. In such cases, you should contact the ship via the phone. When the ship requires a ‘Distress Relay’ call or the ship appears not to reply, you should transmit ‘Distress Relay.’ (p. 37)

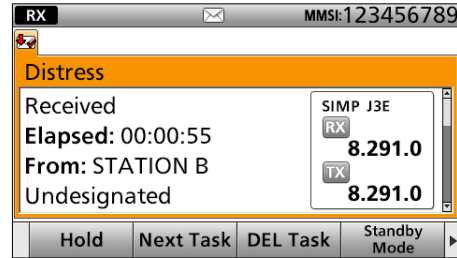

**Information**

- One of the Emergency frequencies is automatically selected. Monitor it, because a coast station may require assistance.
- Rotate [CH/GRP] to confirm the call contents.
- See page 29 for details of the software key functions in the DSC Task mode.

**NOTE:** When you select [Accept] in step 2, you can send the Relay call in the DSC Task mode. To send the Relay call, go to step 3. If you return to the Main screen without sending the Relay call, go to step 10.

### Receiving a Distress Call

- When a Distress call is received:
  - Alarm sounds.
  - The following screen is displayed and the backlight blinks.
  - “” is displayed and “” blinks.
 Push [Alarm Off] .

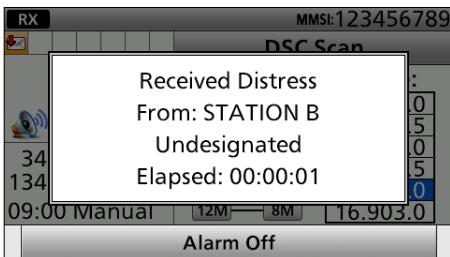

- Select your desired action.
  - ① To send an acknowledgement, push [Accept] .

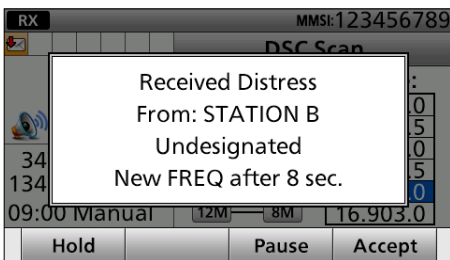

- [Hold]: Push [Hold] to return to the Main screen.
- [Pause]: Push [Pause] to pause the countdown.
- [Accept]: Push [Accept] to enter the DSC Task mode.

- Push [▶] to scroll the software key functions.
- Push [Relay] .

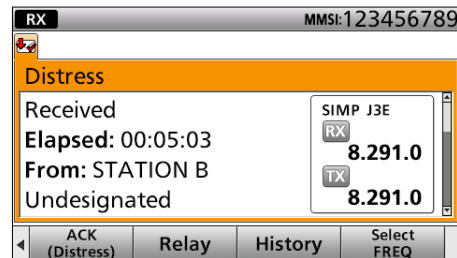

- When the confirmation screen is displayed, push [OK].
- Select “Address,” then push [ENT].
- Select the desired Individual address, or “Manual Input,” then push [ENT].

- Select your desired Individual ID, or "Manual Input." (Example: STATION A)

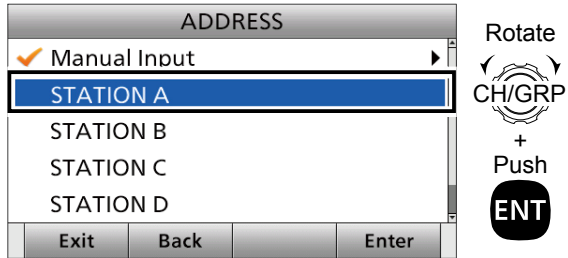

**NOTE:** When you select "Manual Input" in this step, push the keypad to manually enter your desired Individual ID.

- Push [Call] to send the Relay call.
- Push [Standby Mode] to return to the Standby mode.

**TIP:** See page 36 for details of sending an acknowledgement.

**TIP:** When you push [Pause] in step 2, the countdown will be paused. Push [Resume] to restart the countdown.

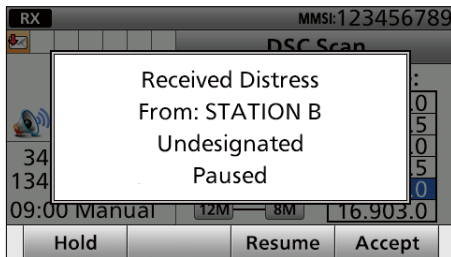

### ◇ Receiving a Distress acknowledgement

- When a Distress Acknowledgement is received:
  - Alarm sounds.
  - The following screen is displayed and the backlight blinks.
  - " " is displayed.

Push [Alarm Off] .

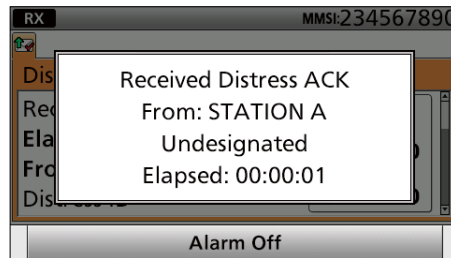

- Push [Close Call RCVD Window] .

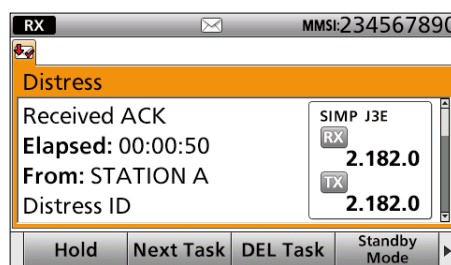
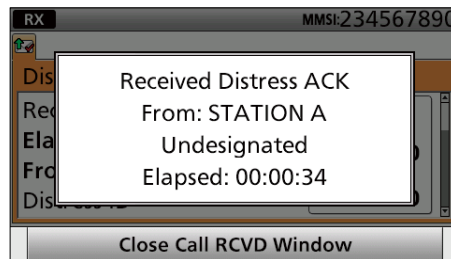



### ① Information

- The communication frequency is automatically selected. Monitor it, because a coast station may require assistance.
  - Rotate [CH/GRP] to confirm the call contents.
  - See page 29 for details of the software key functions in the DSC Task mode.
- Push [Standby Mode]  to return to the Standby mode.

■ Receiving DSC calls

◇ Receiving a Distress Cancel call

- When a Distress Cancel call is received:
  - Alarm sounds.
  - The following screen is displayed and the backlight blinks.
  - " is displayed and " blinks.

Push [Alarm Off] .

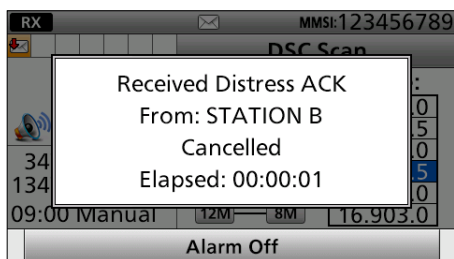

- Select your desired action.
  - To send an acknowledgement, push [Accept] .

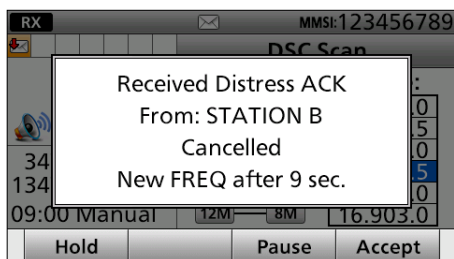

[Hold]: Push [Hold]  to return to the Main screen.

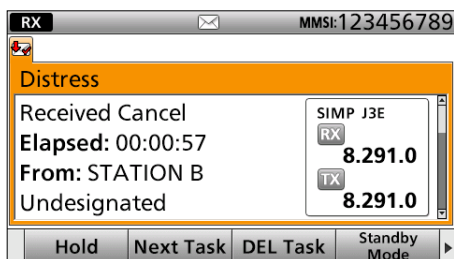

[Pause]: Push [Pause]  to pause the countdown.

[Accept]: Push [Accept]  to enter the DSC Task mode.





① Information

- The communication frequency is automatically selected. Monitor it, because a coast station may require assistance.
  - Rotate [CH/GRP] to confirm the call contents.
  - See page 29 for details of the software key functions in the DSC Task mode.
- Push [Standby Mode]  to return to the Standby mode.

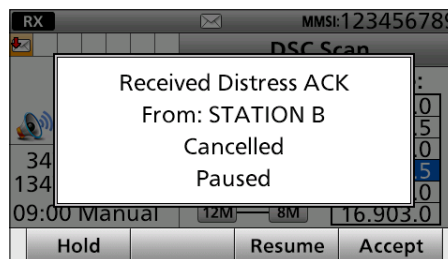
**TIP:** When you push [Pause]  in step 2, the countdown will be paused. Push [Resume]  to restart the countdown.



◇ Receiving a Distress Relay call

- When a Distress Relay call is received:
  - Alarm sounds.
  - The following screen is displayed and the backlight blinks.
  - " is displayed and " blinks.

Push [Alarm Off] .

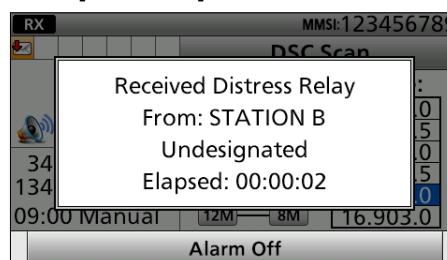

- Select your desired action.
  - To send an acknowledgement, push [Accept] .

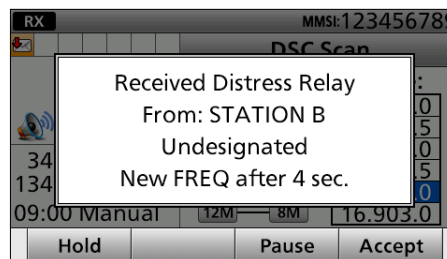

[Hold]: Push [Hold]  to return to the Main screen.

[Pause]: Push [Pause]  to pause the countdown.

[Accept]: Push [Accept]  to enter the DSC Task mode.



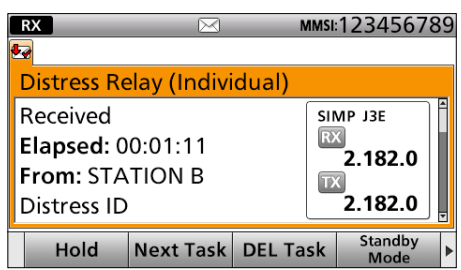

**Information**

- The communication frequency is automatically selected. Monitor it, because a coast station may require assistance.
- Rotate [CH/GRP] to confirm the call contents.
- See page 29 for details of the Software key functions in the DSC Task mode.

3. Push [Standby Mode] to return to the Standby mode.

**TIP:** See page 42 for details of sending acknowledgement.

**TIP:** When you push [Pause] in step 2, the countdown will be paused. Push [Resume] to restart the countdown.

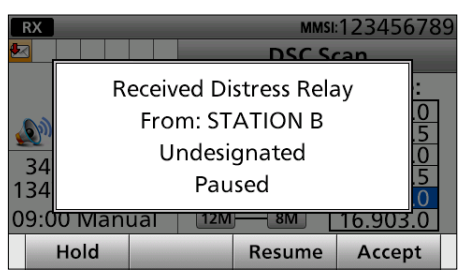

**Receiving a Distress Relay acknowledgement**

1. When a Distress Relay Acknowledgement is received:
  - Alarm sounds.
  - is displayed.
  - The following screen is displayed and the backlight blinks.

Push [Alarm Off] .

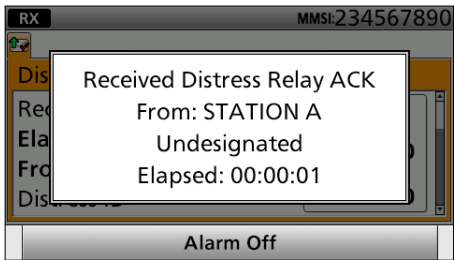

2. Push [Close Call RCVD Window] .

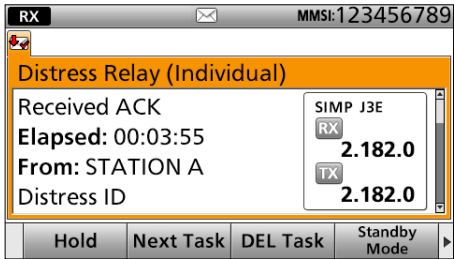
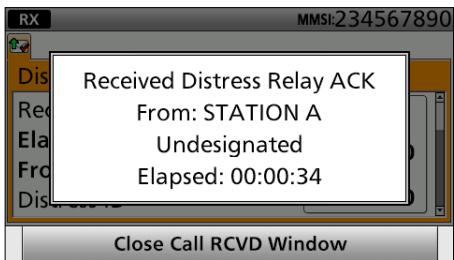

**Information**

- The communication frequency is automatically selected. Monitor it, because a coast station may require assistance.
- Rotate [CH/GRP] to confirm the call contents.
- See page 29 for details of the Software key functions in the DSC Task mode.

3. Hold down [PTT] to announce your situation.
4. Push [Standby Mode] to return to the Standby mode.

■ Receiving DSC calls

◇ Receiving an Individual call

**NOTE:** When the “Individual ACK” item is set to Auto, the transceiver automatically sends an acknowledgement. In that case, both the TX and RX calls are stored in the Transmitted and Received Call Logs. (p. 69)

**NOTE:** To receive an Individual call, push [D-SCAN] to enter the DSC watch mode.

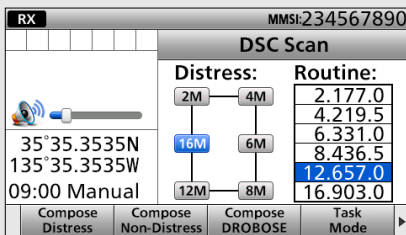

- When an Individual call is received:
  - Alarm sounds.
  - The following screen is displayed and the backlight blinks.
  - “” is displayed and “” blinks.

Push [Alarm Off] .

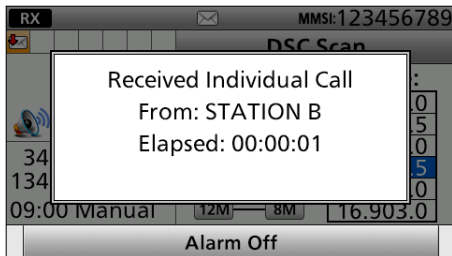

- Select your desired action.
  - To send an acknowledgement, push [Accept] .

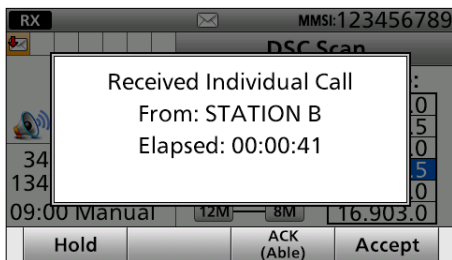

- [Hold]: Push [Hold] to return to the Main screen.
- [ACK (Able)]: Push [ACK (Able)] to send an acknowledgment without any changes.
- [Accept]: Push [Accept] to enter the DSC Task mode.

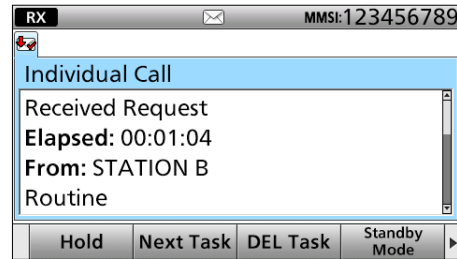

- Rotate [CH/ENT] to confirm the call contents.
- See page 29 for details of the Software key functions in the DSC Task mode.

**NOTE:** When you select “Accept” in step 2, you can send the acknowledgement in the DSC Task mode. To send the acknowledgement, go to step 3. If you return to the Main screen without sending the acknowledgement, go to step 7.

- Push to scroll the software key function.
- Push a desired key to select an acknowledgement option.
- Push [Call] to send the Individual acknowledgement.
- Hold down [PTT] to communicate.
- Push [Standby Mode] to return to the Standby mode.

**TIP:** When you send the acknowledgement, select one of 3 options, depending on your situation. See page 45 for details of the Individual acknowledgement procedure.

◇ Receiving an Individual acknowledgement

After sending an Individual call, while the screen shown below is displayed, you can receive an Individual acknowledgement.

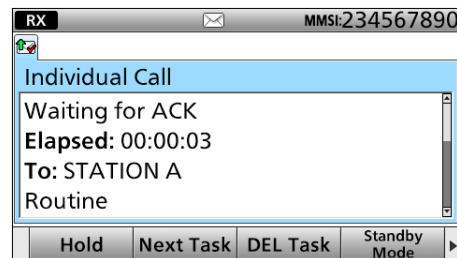

**When receiving “ACK (able)”:**

You can make the voice communication on the frequency that you specified when you sent the call.

1. When an Individual acknowledgement “ACK (able)” is received:
  - Alarm sounds.
  - The following screen is displayed and the backlight blinks.
  - “” is displayed.

Push [Alarm Off] .

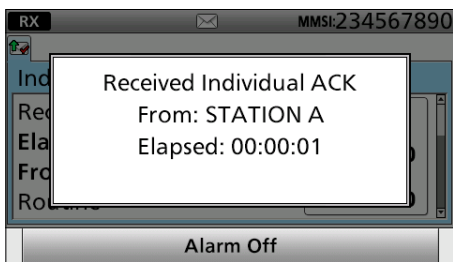

2. Push [Close Call RCVD Window] .

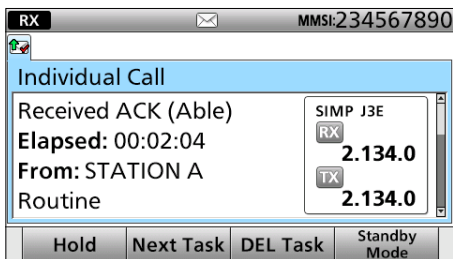
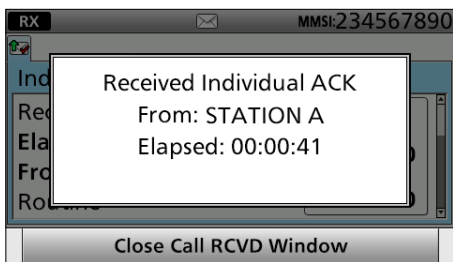

- Automatically selects the communication frequency that you specified when sending the call.
- Rotate [CH/GRP] to confirm the call contents.
- See page 29 for details of the software key functions in the DSC Task mode.
3. Hold down [PTT] to communicate.
4. Push [Standby Mode]  to return to the Standby mode.

**When receiving “ACK (unable)”:**

You cannot make the voice communication.

1. When an Individual acknowledgement “ACK (unable)” is received:
  - Alarm sounds.
  - The following screen is displayed and the backlight blinks.
  - “” is displayed.

Push [Alarm Off] .

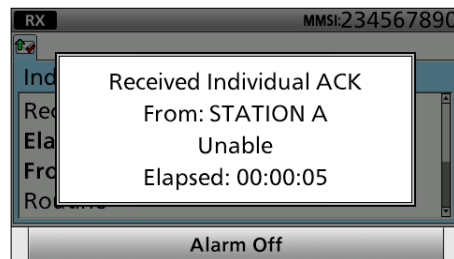

2. Push [Close Call RCVD Window] .

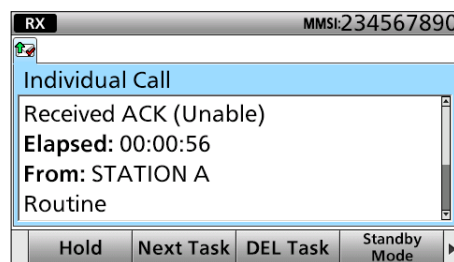
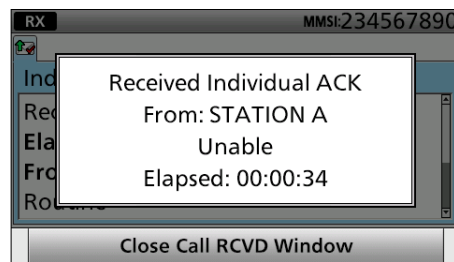

- Rotate [CH/GRP] to confirm the call contents.
- See page 29 for details of the Software key functions in the DSC Task mode.
3. Push [Standby Mode]  to return to the Standby mode.

► Continued on the next page.

■ Receiving DSC calls

◇ Receiving an Individual acknowledgement (continued)

When receiving “ACK (New CH)”:

1. When an Individual acknowledgement “ACK (New CH)” is received:
  - Alarm sounds.
  - The following screen is displayed and the backlight blinks.
  - “.

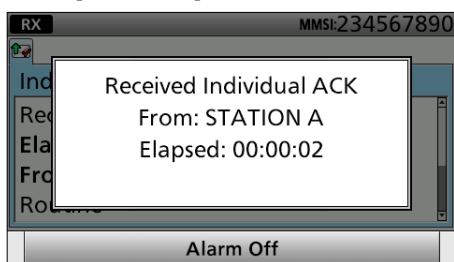

2. Push [Close Call RCVD Window] .

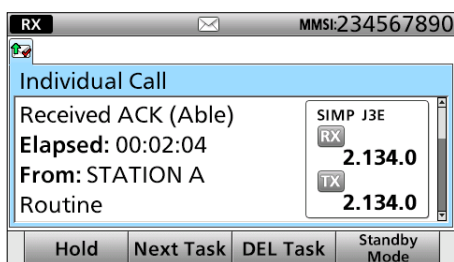
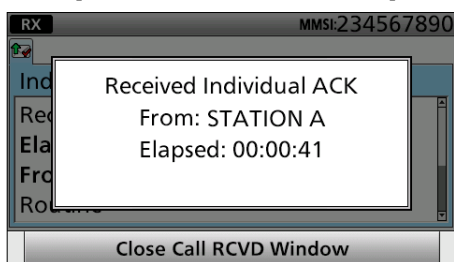



① Information

- Automatically selects the communication frequency that specified by the called station.
  - Rotate [CH/GRP] to confirm the call contents.
  - See page 29 for details of the software key functions in the DSC Task mode.
3. Hold down [PTT] to communicate.
  4. Push [Standby Mode]  to return to the Standby mode.

◇ Receiving a Group call

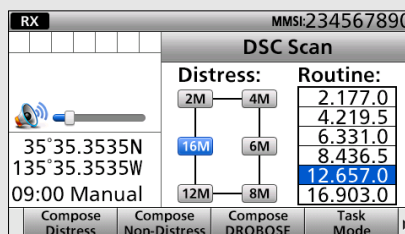
**NOTE:** To receive a Group call, push [D-SCAN] to enter the DSC watch mode.





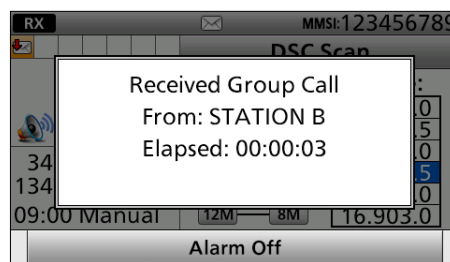

1. When a Group call is received:
  - Alarm sounds.
  - The following screen is displayed and the backlight blinks.
  - “

Push [Alarm Off] .

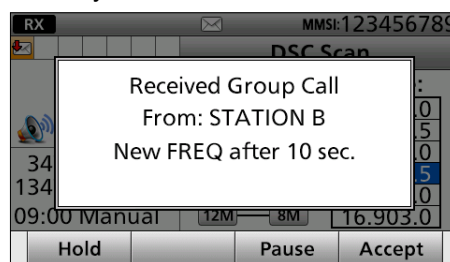

2. Select your desired action.



- [Hold]: Push [Hold]  to return to the Main screen.
- [Pause]: Push [Pause]  to pause the countdown.
- [Accept]: Push [Accept]  to enter the DSC Task mode.

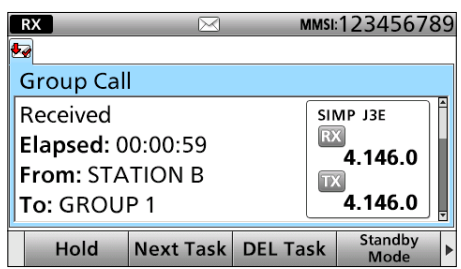

**Information**

- Monitors the communication frequency specified by the calling station for an announcement from the calling station.
- Rotate [CH/GRP] to confirm the call contents.
- See page 29 for details of the software key functions in the DSC Task mode.

3. Push [Standby Mode] to return to the Standby mode.

**TIP:** When you push [Pause] in step 2, the countdown will be paused. Push [Resume] to restart the countdown.

**Receiving a Geographical Area call**

1. When a Geographical Area call (for the area you are in) is received:
  - Alarm sounds.
  - The following screen is displayed and the backlight blinks.
  - “” is displayed and “” blinks.

Push [Alarm Off] .

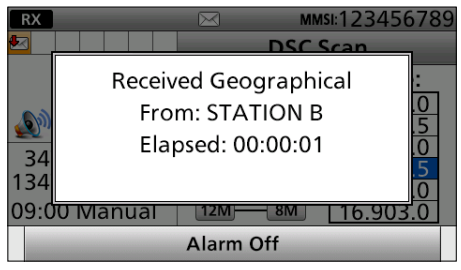

2. Select your desired action.

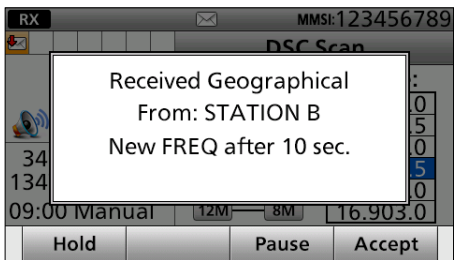

- [Hold]: Push [Hold] to return to the Main screen.
- [Pause]: Push [Pause] to pause the countdown.
- [Accept]: Push [Accept] to enter the DSC Task mode.

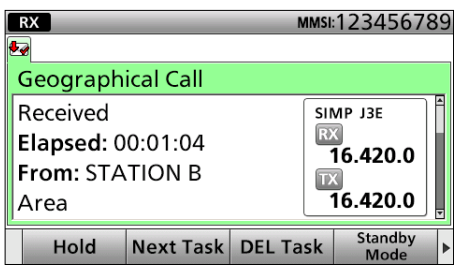

**Information**

- Monitors the communication frequency specified by the calling station for an announcement from the calling station.
- Rotate [CH/GRP] to confirm the call contents.
- See page 29 for details of the software key functions in the DSC Task mode.



3. Push [Standby Mode] to return to the Standby mode.

**TIP:** When you push [Pause] in step 2, the countdown will be paused. Push [Resume] to restart the countdown.

■ Receiving DSC calls

◇ Receiving a Position Request call

**NOTE:** When “Position ACK” is set to “Auto,” the transceiver automatically replies to the call. In that case, both the TX and RX calls are stored in the Transmitted and Received Call Logs. (Default: Manual)

- When a Position Request call is received:
  - Alarm sounds.
  - The following screen is displayed and the backlight blinks.
  - “” is displayed and “” blinks.

Push [Alarm Off] .

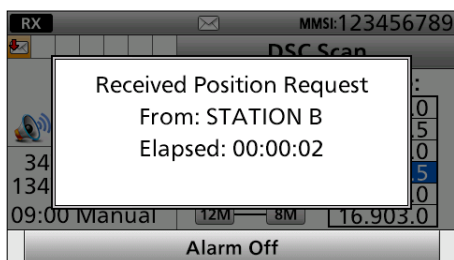

- Select your desired action.

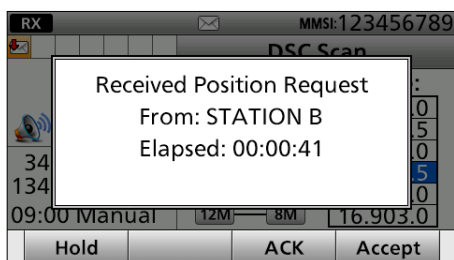

[Hold]: Push [Hold]  to return to the Main screen.

[ACK] Push [ACK]  to send an acknowledgement.

[Accept]: Push [Accept]  to enter the DSC Task mode.

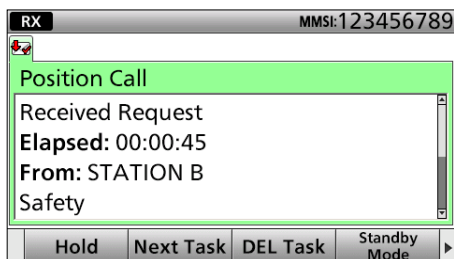

- ① Rotate [CH/GRP] to confirm the call contents.
- ① See page 29 for details of the software key functions in the DSC Task mode.

- Push [Standby Mode]  to return to the Standby mode.

**TIP:** See page 51 for details on sending an acknowledgement.

◇ Receiving a Position Request acknowledgement

- When a Position Request acknowledgement is received:
  - Alarm sounds.
  - The following screen is displayed and the backlight blinks.
  - “” is displayed.

Push [Alarm Off] .



- Push [Close Call RCVD Window] .

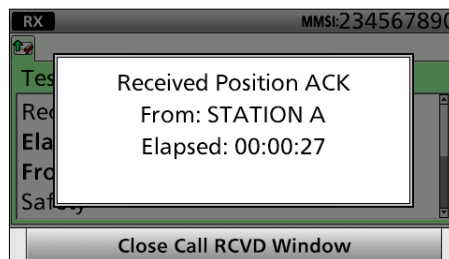

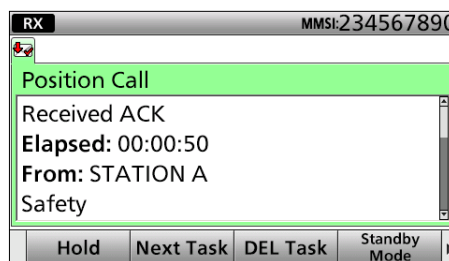

Push any



- ① Rotate [CH/GRP] to confirm the call contents.
  - ① See page 29 for details of the software key functions in the DSC Task mode.
- Push [Standby Mode]  to return to the Standby mode.

### ◇ Receiving a Polling Request call

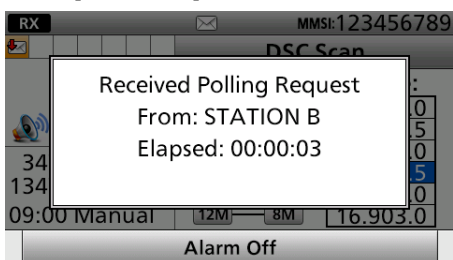

**NOTE:** When “Polling ACK” is set to “Auto,” the transceiver automatically replies to the call. In that case, both the TX and RX calls are stored in the Transmitted and Received Call Logs. (Default: Auto)

- When a Polling Request call is received:
    - Alarm sounds.
    - The following screen is displayed and the backlight blinks.
    - “” is displayed and “” blinks.
- Push [Alarm Off] 

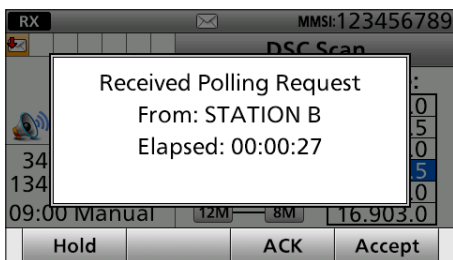

- Select your desired action.



- [Hold]: Push [Hold]  to return to the Main screen.
- [ACK] Push [ACK]  to send an acknowledgement.
- [Accept]: Push [Accept]  to enter the DSC Task mode.

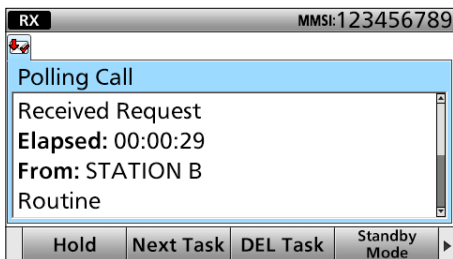



- ① Rotate [CH/GRP] to confirm the call contents.
  - ① See page 29 for details of the Software key functions in the DSC Task mode.
- Push [Standby Mode]  to return to the Standby mode.

**TIP:** See page 52 for details on sending an acknowledgement.

### ◇ Receiving a Test call

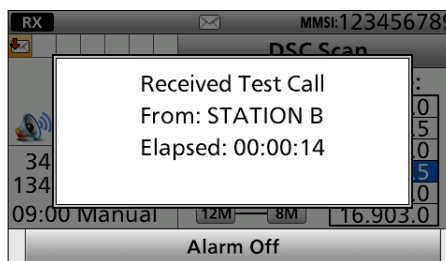

**NOTE:** When “Test ACK” is set to “Auto,” the transceiver automatically replies to the call. In that case, both the TX and RX calls are stored in the Transmitted and Received Call Logs. (Default: Auto)

- When a Test call is received:
    - Alarm sounds.
    - The following screen is displayed and the backlight blinks.
    - “” is displayed and “” blinks.
- Push [Alarm Off] 

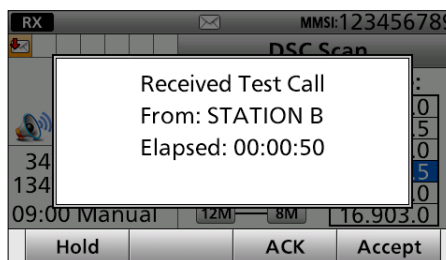

- Select your desired action.



- [Hold]: Push [Hold]  to return to the Main screen.
- [ACK] Push [ACK]  to send an acknowledgement.
- [Accept]: Push [Accept]  to enter the DSC Task mode.

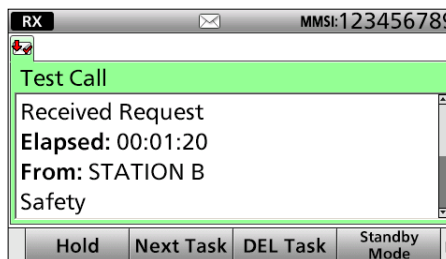



- ① Rotate [CH/GRP] to confirm the call contents.
  - ① See page 29 for details of the Software key functions in the DSC Task mode.
- Push [Standby Mode]  to return to the Standby mode.

**TIP:** See page 53 for details on sending an acknowledgement.

■ Receiving DSC calls

◇ Receiving a Test acknowledgement

- When a Test acknowledgement is received:
  - Alarm sounds.
  - The following screen is displayed and the backlight blinks.
  - " " is displayed.

Push [Alarm Off] .

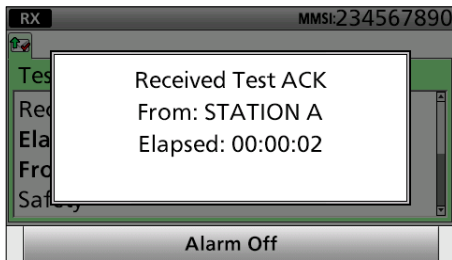

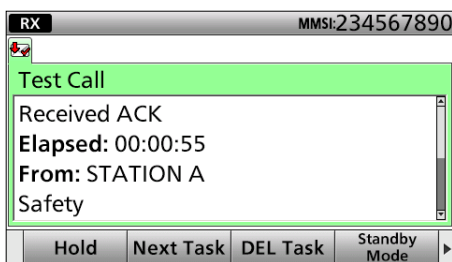
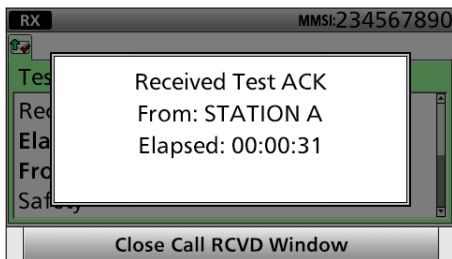

- Push [Close Call RCVD Window] .



- Rotate [CH/GRP] to confirm the call contents.
- See page 29 for details of the Software key functions in the DSC Task mode.

- Push [Standby Mode]  to return to the Standby mode.

◇ Receiving a Medical Transports call

- When a Medical Transports call is received:
  - Alarm sounds.
  - The following screen is displayed and the backlight blinks.
  - " " is displayed and " " blinks.

Push [Alarm Off] .

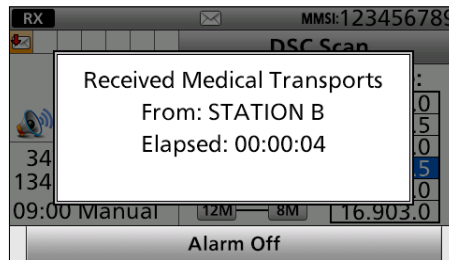

- Select your desired action.

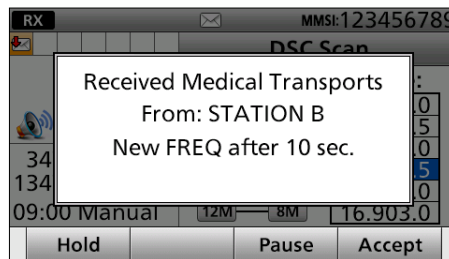

[Hold]: Push [Hold]  to return to the Main screen.

[Pause]: Push [Pause]  to pause the countdown.

[Accept]: Push [Accept]  to enter the DSC Task mode.

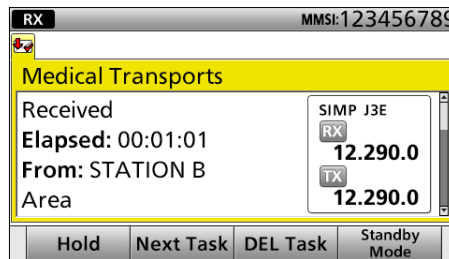



① Information

- Monitors the communication frequency specified by the calling station for an announcement from the calling station.
- Rotate [CH/GRP] to confirm the call contents.
- See page 29 for details of the Software key functions in the DSC Task mode.



- Push [Standby Mode]  to return to the Standby mode.

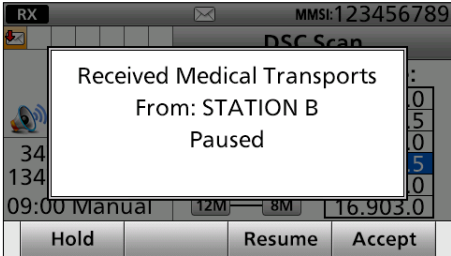

**TIP:** When you push [Pause]  in step 2, the countdown will be paused. Push [Resume]  to restart the countdown.



◇ Receiving a Ships and Aircraft call

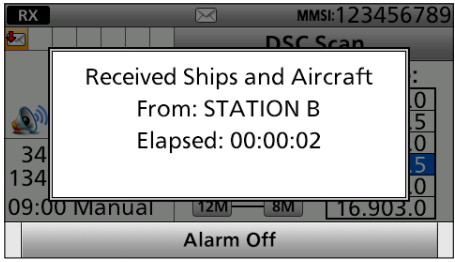

- When a Ships and Aircraft call is received:
  - Alarm sounds.
  - The following screen is displayed and the backlight blinks.
  -  is displayed and  blinks.

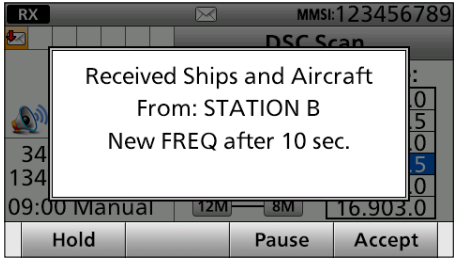

Push any

- Select your desired action.



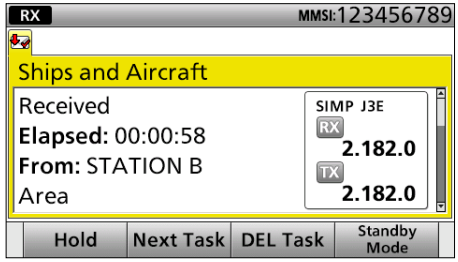

- [Hold]: Push [Hold]  to return to the Main screen.
- [Pause]: Push [Pause]  to pause the countdown.
- [Accept]: Push [Accept]  to enter the DSC Task mode.



① Information

- Monitors the communication frequency specified by the calling station for an announcement from the calling station.
  - Rotate [CH/GRP] to confirm the call contents.
  - See page 29 for details of the software key functions in the DSC Task mode.
- Push [Standby Mode]  to return to the Standby mode.

**TIP:** When you push [Pause]  in step 2, the countdown will be paused. Push [Resume]  to restart the countdown.

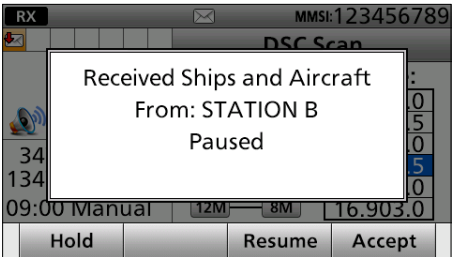

## Received Call log

The transceiver automatically stores up to 50 distress messages and 50 other messages, and they can be used as a supplement to your logbook.

### Information

#### Software key functions in the RECIEVED CALL LOG screen:

- [Exit]: Push to return to the Main screen.
- [Back]: Push to return to the previous screen.
- [Print]: Push to print out the selected message when a printer is connected to the transceiver.
- [Enter]: Push to go to the next screen.
- [Delete]: Push to delete the selected message.

### NOTE:

- When there is an unread DSC message, “✉” blinks on the information area of the LCD.
- The Distress messages are stored in “Distress.”
- “✉” is displayed when there are unread DSC messages.
- “✉” is displayed when there are no unread DSC messages.
- No icon is displayed when there are no DSC messages.

### Distress message

1. Push [DSC Log]  to display the RECIEVED CALL LOG screen.
2. Select “Distress,” then push [ENT].
3. Select your desired item.

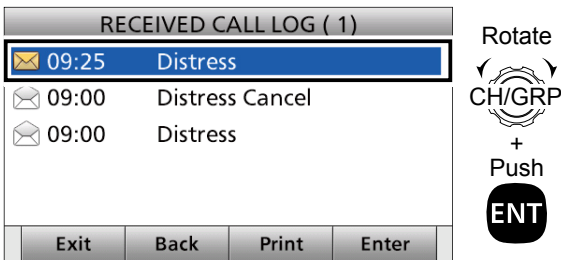

4. Rotate [CH/GRP] to confirm the message contents.
5. Push [Standby Mode]  to return to the Standby mode.

## Transmitted Call log

The transceiver automatically stores up to 50 transmitted calls, and the logs can be used as a supplement to your logbook.

1. Push [MENU].
2. Select “Transmitted Call Log.” (DSC Log > Transmitted Call Log)

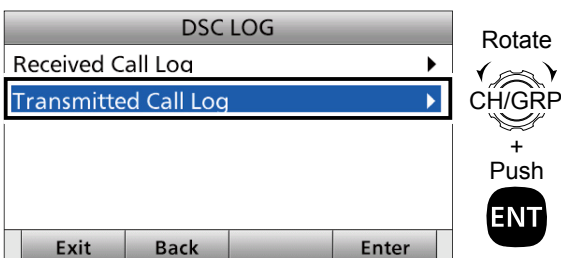

### Other messages

1. Push [DSC Log]  to display the RCVD CALL LOG screen.
2. Select “Others,” then push [ENT].
3. Select your desired item.

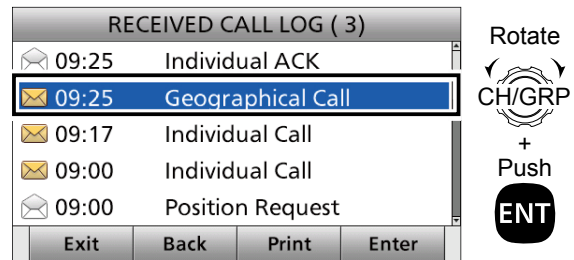

4. Rotate [CH/GRP] to confirm the message contents.
5. Push [Standby Mode]  to return to the Standby mode.

### Information

#### Software key functions in the TRANSMITTED CALL LOG screen:

- [Exit]: Push to return to the Main screen.
- [Back]: Push to return to the previous screen.
- [Print]: Push to print out the selected message when a printer is connected to the transceiver.
- [Enter]: Push to go to the next screen.
- [Delete]: Push to delete the selected message.

3. Select your desired item.

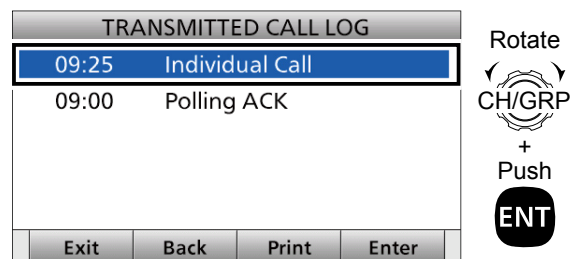

4. Rotate [CH/GRP] to confirm the message contents.
5. Push [Standby Mode]  to return to the Standby mode.

## ■ DSC Settings

- ◇ Position Input (See page 27)
- ◇ Individual ID (See page 23)
- ◇ Group ID (See page 25)

### ◇ DSC Frequency

This set frequencies are selectable when you want to send an Individual call, Group call, Geographical Area call, Position Request call, or Test call. Usually your dealer has set all the DSC frequencies to use.

#### To add a new DSC frequency:

1. Push [MENU].
2. Select "DSC Settings."

MENU

- Compose Distress ▶
- Compose Non-Distress ▶
- Compose DROBOSE ▶
- DSC Log ▶
- DSC Settings ▶**
- Radio Settings ▶

Rotate CH/GRP + Push ENT

3. Select "DSC Frequency."

DSC SETTINGS

- Position Input ▶
- Individual ID ▶
- Group ID ▶
- DSC Frequency ▶**
- Individual ACK: Manual ▶

Exit Back Enter

Rotate CH/GRP + Push ENT

4. Select a DSC frequency number and push [Edit] . (Example: 50)

DSC FREQUENCY

- 46 Not Used
- 47 Not Used
- 48 Not Used
- 49 Not Used
- 50 Not Used**

Edit Delete Print

Rotate CH/GRP



5. Select "Use:."

DSC FREQUENCY (50)

- Use: Not Used ▶**
- Frequency
- RX Frequency: -----
- TX Frequency: -----
- Name:

Exit Back Save Enter

Rotate CH/GRP + Push ENT

6. Select an option. (Example: Call)

DSC FREQUENCY (50)

- Communication
- Call**
- ✓ Not Used

Exit Back Enter

Rotate CH/GRP + Push ENT

- Communication: Communication frequency that is used to talk with other station after DSC call communications.
- Call: DSC call frequency that is used to send DSC calls.

7. Select "Frequency."

DSC FREQUENCY (50)

- Use: Call ▶
- Frequency ▶**
- RX Frequency: -----
- TX Frequency: -----
- Name: ▶

Exit Back Save Enter

Rotate CH/GRP + Push ENT

8. Enter an RX frequency. After entering, select "Done" and push [ENT]. (Example: 4.390.0)

DSC FREQUENCY (50)

RX Frequency: -4390.0

0 1 2 3 4 5 6 7 8 9

← → Done

Exit Back

Push numeric keypad + Rotate CH/GRP to select a character

9. Enter a TX frequency. After entering, select "Done" and push [ENT]. (Example: 4.098.0)

DSC FREQUENCY (50)

TX Frequency: -4098.0

0 1 2 3 4 5 6 7 8 9

← → Done

Exit Back

Push numeric keypad + Rotate CH/GRP to select a character

► Continued on the next page.

■ DSC Settings

◇ DSC Frequency (Continued)

10. Select "Name."

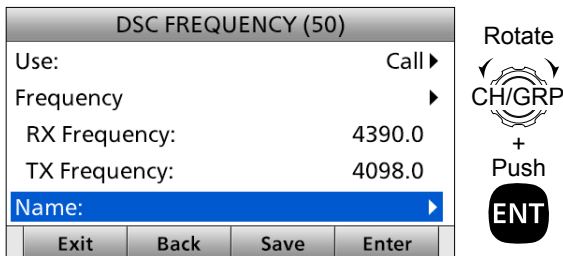

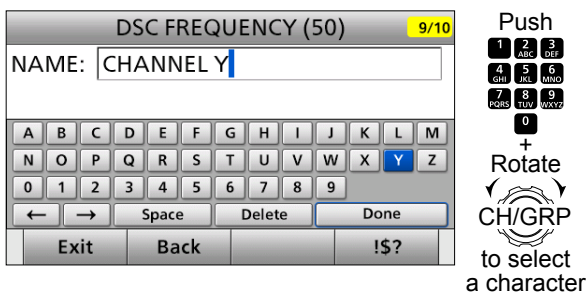

11. Enter a DSC frequency name. After entering, select "Done" and push [ENT].

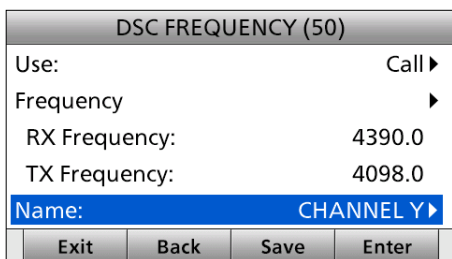

12. Push [Save] .



• "Are You Sure?" is displayed.

- 13. Push [OK]  to save the content.
- 14. Push [▶] to scroll the Software key functions.
- 15. Push [Exit]  to return to the Main screen.

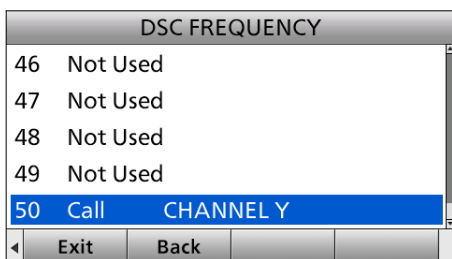

◇ Automatic acknowledgement

These items set the Automatic Acknowledgement function. When you receive an Individual call, Position Request call, Polling Request call or Test call, the transceiver automatically sends each acknowledgement, if "Auto" is set.

**NOTE:** When you set the "Individual ACK" item to "Auto (Unable)," and receive the Individual call, the transceiver automatically sends the acknowledgment including "ACK (Unable)" (No Reason Given).

1. Push [MENU].
2. Select an item.  
(DSC Settings > **Individual ACK**, **Position ACK**, **Polling ACK**, **Test ACK**)
3. Select an option, and then push [ENT].

**Individual ACK** (Default: Manual)

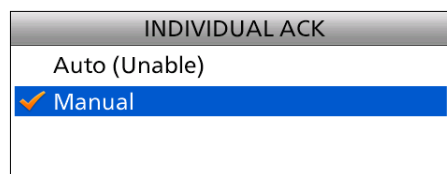

**Position ACK** (Default: Manual)

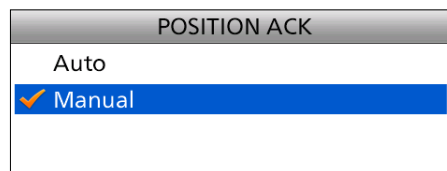

**Polling ACK** (Default: Auto)

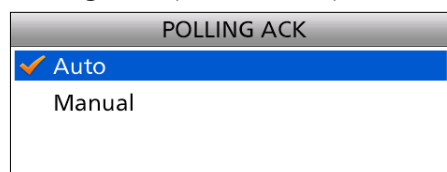

**Test ACK** (Default: Auto)

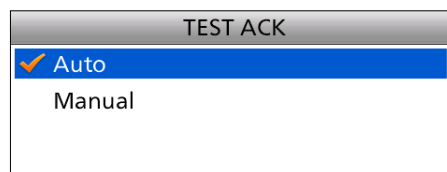

4. Push [MENU] to return to the Main screen.

### ◇ Setting the “Medical Transports” item display option

You can select whether or not the “Medical Transports” item is displayed in the COMPOSE NON-DISTRESS screen.

1. Push [MENU].
2. Select “Medical Transports,” then push [ENT].  
(DSC Settings > **Medical Transports**)

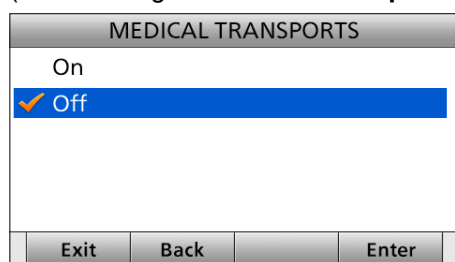

3. Select an option, then push [ENT].
  - On: Displayed in the COMPOSE NON-DISTRESS screen.
  - Off: Not displayed in the COMPOSE NON-DISTRESS screen. (Default)
4. Push [MENU] to return to the Main screen.

### ◇ Setting the “Ships and Aircraft” item display option

You can select whether or not the “Ships and Aircraft” item is displayed in the COMPOSE NON-DISTRESS screen.

1. Push [MENU].
2. Select “Ships and Aircraft,” then push [ENT].  
(DSC Settings > **Ships and Aircraft**)

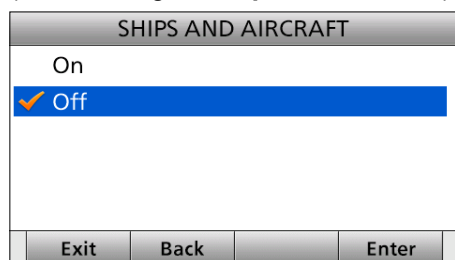

3. Select an option, then push [ENT].
  - On: Displayed in the COMPOSE NON-DISTRESS screen.
  - Off: Not displayed in the COMPOSE NON-DISTRESS screen. (Default)
4. Push [MENU] to return to the Main screen.

### ◇ Distress Scanning Receiver

You can turn the Distress Scanning Receiver function ON or OFF on each Emergency frequency.

**NOTE:** You cannot turn OFF the function on 2187.5 kHz and 8414.5 kHz, and 1 of the remaining 4 frequencies.

1. Push [MENU].
2. Select “Distress Scanning Receiver,” then push [ENT].  
(DSC Settings > **Distress Scanning Receiver**)

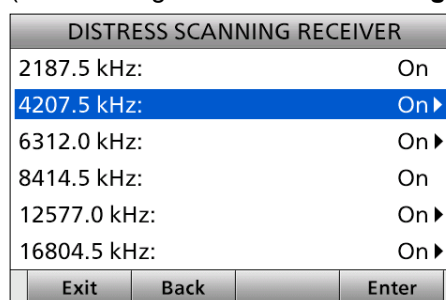

3. Select a frequency then push [ENT].

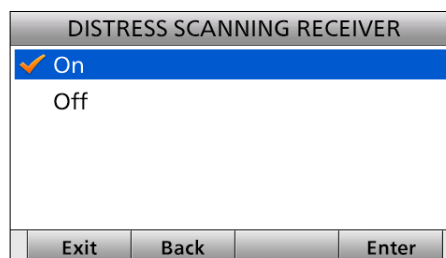

4. Select an option, then push [ENT].
  - On: The Emergency frequency is scanned during the Distress scan.
  - Off: The Emergency frequency is skipped during the Distress scan.
5. Push [MENU] to return to the Main screen.

■ DSC Settings

◇ **Setting the 10 Second Delay**

Select whether or not the transceiver automatically switches to the displayed frequency 10 seconds after receiving a DSC call.

By regulation, after receiving a DSC call, the transceiver automatically switches the operating channel to the displayed frequency. However, when you set this function to "OFF", the transceiver remains on the operating channel, even after receiving a DSC call.

1. Push [MENU].
2. Select "10 Second Delay," then push [ENT].  
(DSC Settings > **10 Second Delay**)

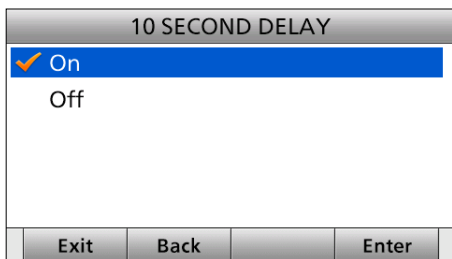

3. Select an option, then push [ENT].
  - On: When receiving a DSC call with a specified frequency, the transceiver automatically switches the operating channel to the displayed frequency. (Default)
  - Off: The transceiver remains on the operating channel until you push [Active]  to enter the DSC Task mode.
4. Push [MENU] to return to the Main screen.

◇ **Setting the Alarm Status**

**Safety/Routine**

Select whether or not to sound an alarm when receiving the Safety or Routine DSC call.

1. Push [MENU].
2. Select an item, then push [ENT].  
(DSC Settings > Alarm Status > **Safety**)  
(DSC Settings > Alarm Status > **Routine**)

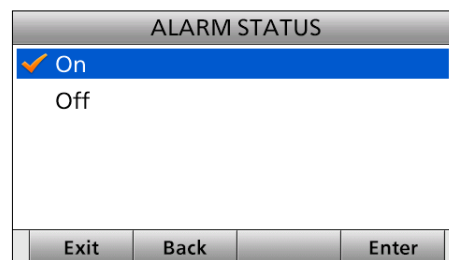

3. Select an option, then push [ENT].
  - On: Alarm sounds. (Default)
  - Off: Alarm does not sound.
4. Push [MENU] to return to the Main screen.

**Warning**

Select whether or not to sound an alarm:

- When no MMSI code is entered.
- When the position data has not been updated for 10 minutes.
- When the position data has not been manually updated for 4 hours.
- After the invalid GPS position data or manually entered position data has not updated for 23.5 hours.

1. Push [MENU].
2. Select "Warning," then push [ENT].  
(DSC Settings > Alarm Status > **Warning**)

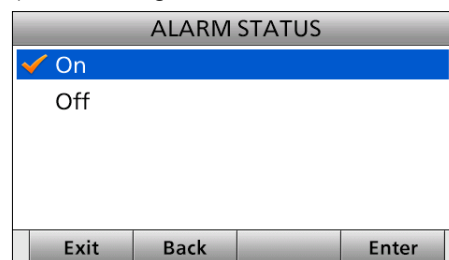

3. Select an option, then push [ENT].
  - On: Alarm sounds. (Default)
  - Off: Alarm does not sound.
4. Push [MENU] to return to the Main screen.

**Self-Terminate**

Select whether or not to sound an alarm when receiving the same Distress call.

1. Push [MENU].
2. Select "Self-Terminate," then push [ENT].  
(DSC Settings > Alarm Status > **Self-Terminate**)

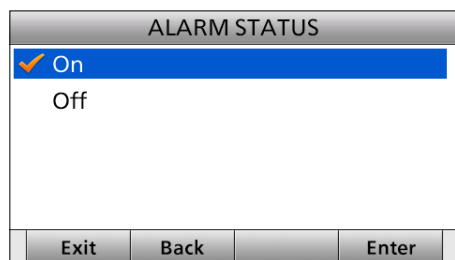

3. Select an option, then push [ENT].
  - On: Alarm sounds. (Default)
  - Off: Alarm does not sound.
4. Push [MENU] to return to the Main screen.

**Discrete**

Select whether or not to sound an alarm when receiving a lower priority DSC call while receiving a higher priority call.

1. Push [MENU].
2. Select "Discrete," then push [ENT].  
(DSC Settings > Alarm Status > **Discrete**)

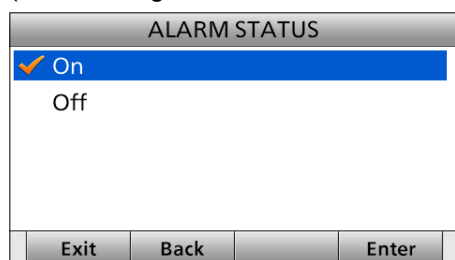

3. Select an option, then push [ENT].
  - On: Alarm sounds. (Default)
  - Off: Alarm does not sound.
4. Push [MENU] to return to the Main screen.

**Auto Print**

Select whether or not to enable the Automatic Print Out function when a DSC call is received. The received DSC call content is printed out if a printer is connected to the transceiver.

1. Push [MENU].
2. Select "Auto Print," then push [ENT].  
(DSC Settings > **Auto Print**)

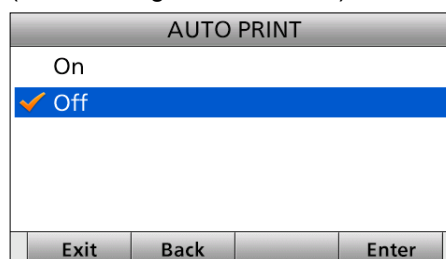

3. Select an option, then push [ENT].
  - On: The received DSC call contents is printed out.
  - Off: The received DSC call contents is not printed out. (Default)
4. Push [MENU] to return to the Main screen.

**DSC Loop Test**

The DSC loop test function sends transmit DSC signals to the receive AF circuit to compare and check the TX and RX signals at the AF level.

1. Push [MENU].
2. Select "DSC Loop Test," then push [ENT].  
(DSC Settings > **DSC Loop Test**)
3. Push [ENT] to start the DSC loop test.

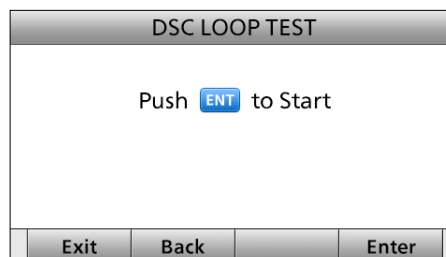

- When the transmit DSC and receive DSC signals match, "OK" is displayed.
4. Push [MENU] to return to the Main screen.

**NOTE:** If "Failed" is displayed in step 3, contact your dealer.

## ■ Menu items

The Menu screen is constructed in a tree structure.  
(p. 9)

**NOTE:** See page 10 about how to select each Menu item.

The following items are described in each section.  
Refer to the pages in parenthesis for details.

## ■ Radio Settings

### ◇ User CHAN (p. 18)

### ◇ ITU Simplex CHAN (p. 18)

### ◇ Max User CHAN

Set the number of the maximum User channels from 1 ~ 160.

### ◇ Auto Tune

Turn the Auto Tune function ON or OFF.  
The Auto Tune function starts tuning automatically when an optional automatic antenna tuner is connected.

### ◇ Scan > Type

Select a Scan type to locate signals.

#### • CHAN/CHAN Resume:

Searches for 20 channels between 1 ~ 20, 21 ~ 40 and 41 ~ 60 that include the scan start channel, or searches for all ITU channels in the band when an ITU channel is selected.

#### • Program:

Searches for signals within the frequency range.  
Searches slower When the squelch is open, and searches faster when squelch is closed.

### ◇ Compose Non-Distress

- Individual calls (p. 43)
- Group calls (p. 45)
- Geographical calls (p. 47)
- Position Request calls (p. 50)
- Test calls (p. 52)

### ◇ Compose DROBOSE (p. 37)

### ◇ DSC Log (p. 69)

### ◇ DSC Settings (p. 70)

### ◇ Radio Settings (p. 75)

### ◇ Configuration (p. 76, 77)

### ◇ Scan > Speed

Set the scanning speed (rate at which channels are searched) from 1 (fast) to 10 (slow).

### ◇ Voice SQL

Turn the Voice Squelch function ON or OFF for when operating in the J3E and H3E modes.

When this function is OFF, the squelch operates as an S-meter squelch for the J3E and H3E modes.



## ■ Configuration

### ◇ Key Beep

Turn the Key Beep function ON or OFF.

- On: When you push a key, a beep sounds. (Default)
- Off: Turns OFF the function for silent operation.



### ◇ UTC Offset

Set the offset time between UTC (Universal Time Coordinated) and your local time to between -14:00 and +14:00 (in 1 minute steps). (Default: 00:00)



### ◇ NMEA Data Output

Set the NMEA 0183 Output functions.

#### DSC Data Output

Select an option for the DSC Data Output function. When receiving a DSC call, the transceiver outputs the NMEA sentences (DSC and DSE) from the NMEA 0183 output port to an external device.

- All Stations: Outputs the NMEA sentences.
- Station List: Outputs the NMEA sentences when you receive a call from the station whose address is entered in your Individual ID list.
- Off: Does not output the NMEA sentences. (Default)

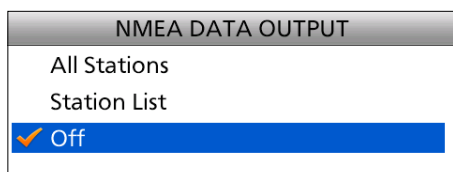

### ◇ Inactivity Timer

Set the inactivity timer.

The count down alarm sounds 10 seconds before the Inactive timer activates.

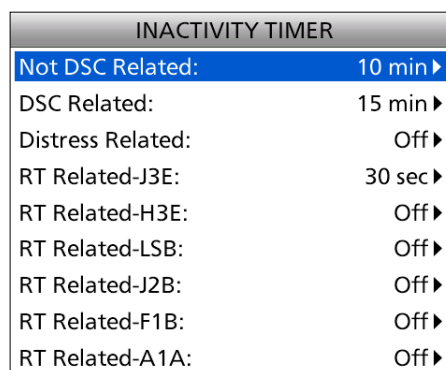

#### • For Non DSC Related, DSC Related, and Distress Related:

Set the inactivity timer to between 1 and 15 minutes (in 1 minute steps) or OFF.

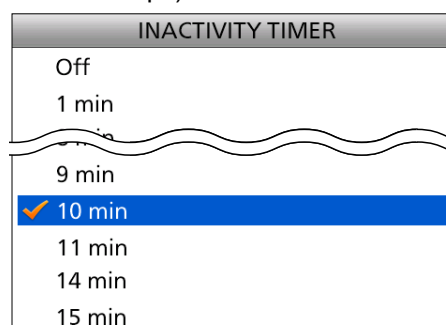

### ◇ Assignment

You can assign some functions to the software keys to create a convenient shortcuts. See page 20 about how to assign.

**Not DSC Related**

(Configuration > Inactivity Timer > **Not DSC Related**)

The transceiver automatically returns to the Main screen if you push no key for this set time period. (Default: 10 min)

This setting is for when the LCD displays a screen other than the Main screen, or one that is not related to DSC.

**DSC Related**

(Configuration > Inactivity Timer > **DSC Related**)

The transceiver automatically returns to the Main screen if you push no key for this set time period. (Default: 15 min)

This setting is for when the LCD displays a screen related to DSC.

**Distress Related**

(Configuration > Inactivity Timer > **Distress Related**)

The transceiver automatically returns to the Main screen if you push no key for this set time period. (Default: Off)

This setting is for when the LCD displays a screen related to the Distress calls

**• For RT Related (J3E):**

Set the inactivity timer to 10 sec, 30 sec, or to between 1 and 10 min (in 1 minute steps).

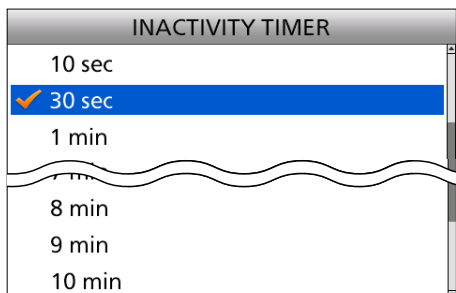

(Configuration > Inactivity Timer > **RT Related-J3E**)

The transceiver automatically cancels the RT mode task if you push no key for this set time period. (Default: 30 sec)

This setting is for when the LCD displays a screen related to the Radio Telephone mode.

**• For RT Related (except J3E):**

Set the inactivity timer 10 sec, 30 sec, between 1 and 10 min (in 1 minute steps), or OFF.

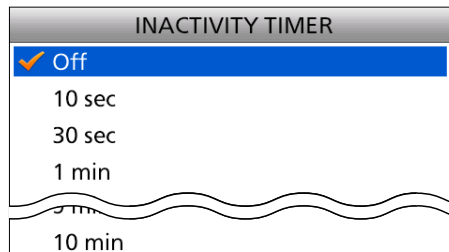

(Configuration > Inactivity Timer > **RT Related-H3E/LSB/J2B/F1B/A1A**)

The transceiver automatically cancels the RT mode task if you push no key for this set time period. (Default: OFF)

This setting is for when the LCD displays a screen related to the Radio Telephone mode.

**◇ MIC Key**

Select the microphone key function ON or OFF. When you select "ON," you can use the keys on the optional HM-214H microphone ([P], [UP], [DOWN] and [D-Scan]).

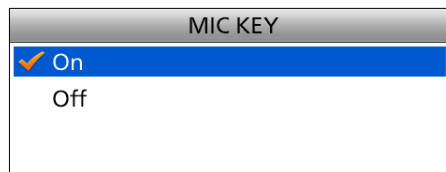

**◇ Software Version**

This item displays the transceiver's software version number.

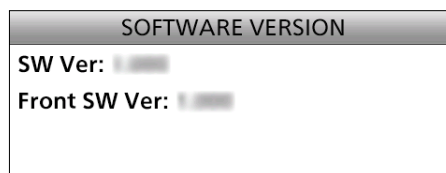

## ■ Supplied accessories

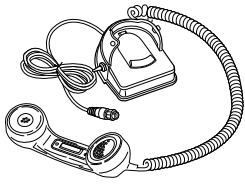

Handset

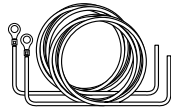

DC power cable  
(Red and Black)



RCA cable  
(for the GPS connection)

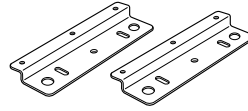

Mounting plates  
for the main unit



Rubber feet

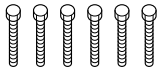

Hex head bolts  
(M6x50)



Hex head bolts  
(M6x15)



Spring washers (M6)

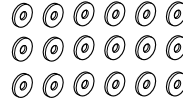

Flat washers (M6)



Hex nuts (M6)



Weatherproof caps



Tuner connector kit



Spare fuses (FGB 5 A)



Ferrite EMI filter  
(for the DC power  
cable)

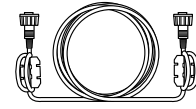

Remote control cable

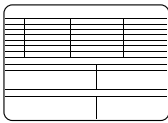

Emergency frequency  
sticker

### Mounting bracket kit for the remote controller

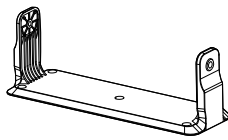

Mounting bracket

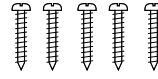

Self-tapping screws (M5)

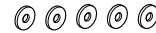

Spring washers (M5)



Flat washers (M5)



Knobs

## ■ Basic connections

### CAUTION:

- After connecting an antenna, tuner control cables, external speaker, or GPS receiver, cover the connectors with rubber vulcanizing tape, as shown below. Covering with the tape prevents water from seeping into the connector.

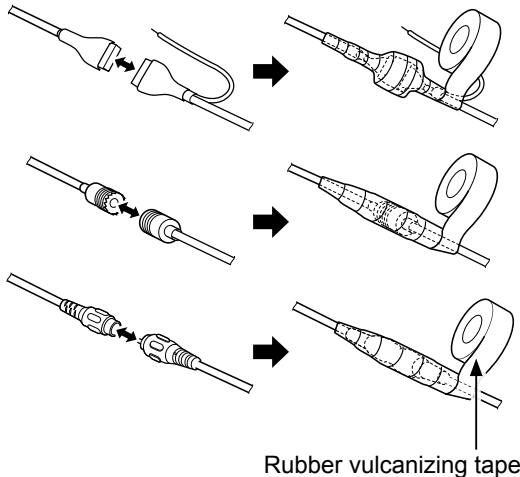

Rubber vulcanizing tape

- **DO NOT** pull the antenna and control cable receptacles. This may cause cable disconnection (in the tuner unit), damage inside the connector, or a bad connection.

**NOTE:** Turn OFF [DC ISOLATE] on the GM800 main unit, or charge the battery while at anchor, otherwise the battery may become exhausted. The GM800 has a high-stability ovenheater type crystal oscillator, and the oscillator's heater is directly connected to the DC power terminals. It keeps its temperature to at a specified level, even if you turn OFF the power by holding down [⏻] on the remote controller.

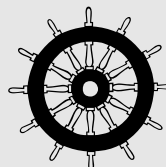

### GM800

**NOTE:** Must be used with the ICOM AT-141.

■ Basic connections

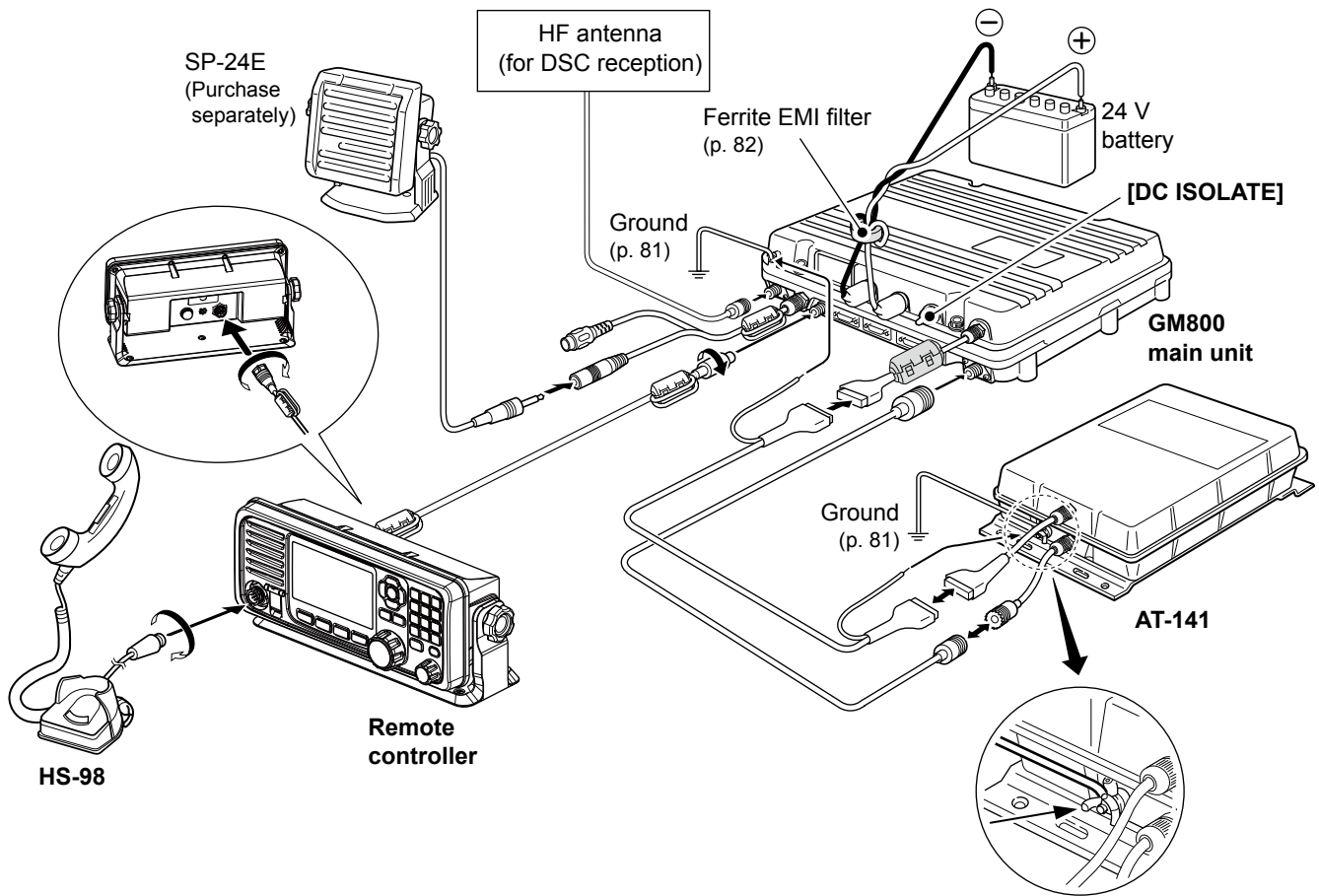

■ Advanced connections

- When a PC is connected, the PC has priority over the remote controller.
- When a PC is connected, you cannot use the remote controller after the set time period. Ask your dealer for details.
- When a PC is connected, operating the PC automatically updates settings on the remote controller.

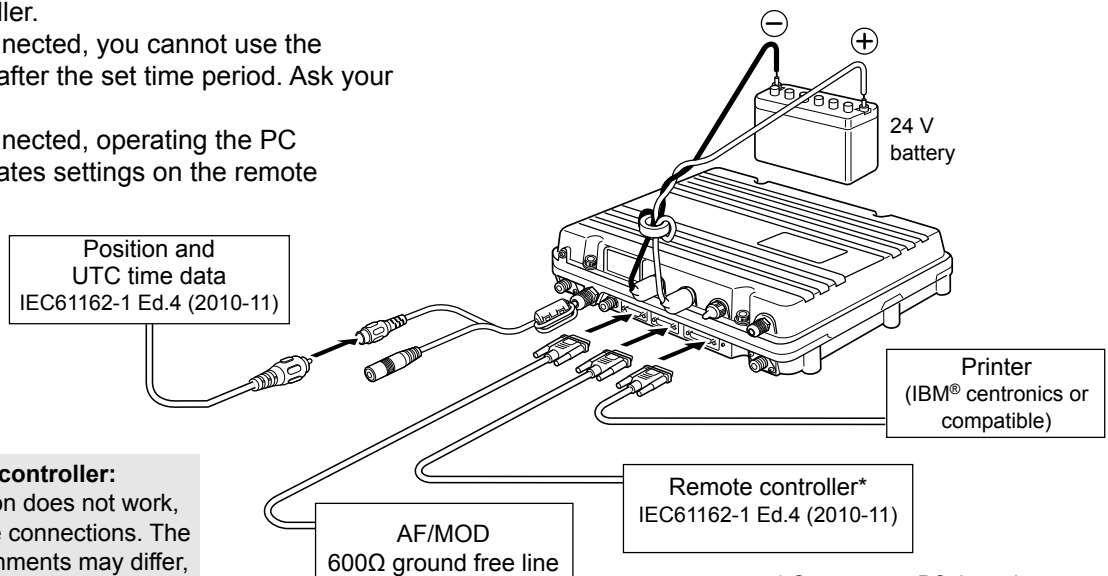

**NOTE for a remote controller:**  
 If the initial connection does not work, try reversing the wire connections. The RS-422A's pin assignments may differ, depending on the manufacturer. See pages 87 and 88 for connector information details.

\* Connect to a PC through an RS-422A cable (D-sub 9-pin) for remote control.

## Ground connection

The transceiver and antenna tuner must have an adequate RF ground connection. Otherwise, the efficiency of the transceiver and antenna tuner may be reduced. Also, electrolysis, electrical shocks and interference from other equipment may occur.

For the best results, use a 50 or 75 mm wide copper strap, and make the connection as short as possible. Ground the transceiver and antenna tuner to one ground point, otherwise the voltage difference (at the RF level) between the 2 ground points may cause electrolysis.

**⚠ WARNING!** When grounding to a metal hull Use Zinc anodes to protect the hull from electrolysis. Ask your dealer or installer for RF grounding details.

**CAUTION:**

- **NEVER** connect the transceiver to a “positive-grounded ship,” otherwise the transceiver will not function.
- Any external units, such as PC, printer and so on, must be properly grounded. We suggest using a wide copper strap.

**Best ground points**

- External ground plate
- Copper screen
- Copper foil

**Acceptable ground points**

- Stainless steel stanchion
- Through mast
- Through hull
- Metal water tank

**Undesirable ground points**

- Engine block
- Ship’s DC battery ground

**Unusable ground points**

(these connections may cause an explosion or electrical shock)

- Gas or electrical pipe
- Fuel tank or oil catch pan

**Ground system example**

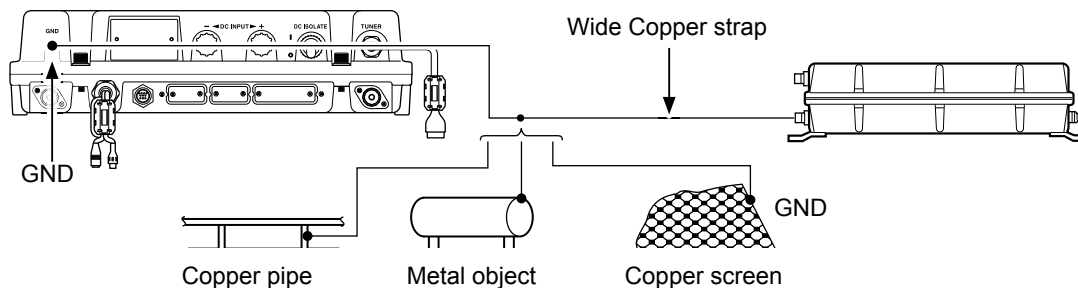

## Software maintenance

The Icom customer support center provides the firmware file for transceiver maintenance. You can update the transceiver’s firmware through a PC.

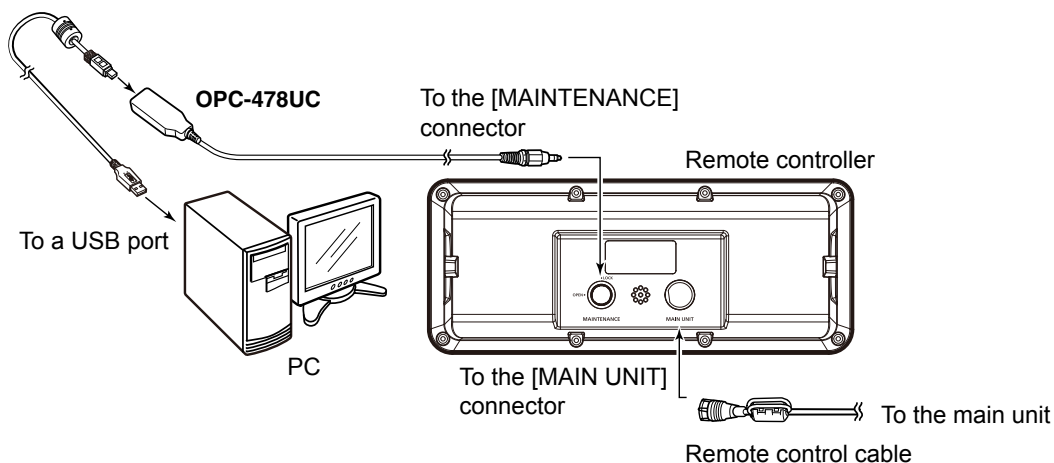

## Power source

The transceiver requires a regulated DC power source of 26.4 V and at least 30 A. Connect a transceiver directly to a 24 V battery in your ship using the supplied DC power cable.

**⚠ WARNING! NEVER** reverse the polarity when connecting the transceiver to a DC power source. This will damage the transceiver.

**CAUTION: BE SURE** to use a 24 V battery.

### • Connecting the DC power cable

**NOTE:** Terminate the cable ends as illustrated below.

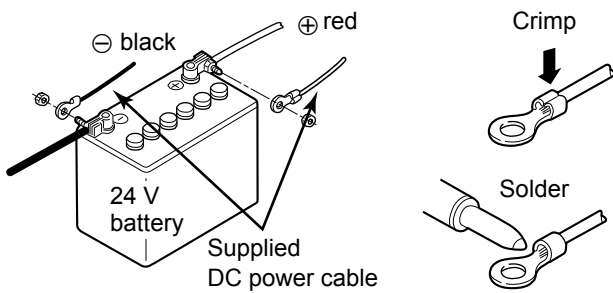

### • Attaching the weatherproof cap

Attach the supplied weatherproof cap for each positive and negative line at the DC power terminal as shown below.

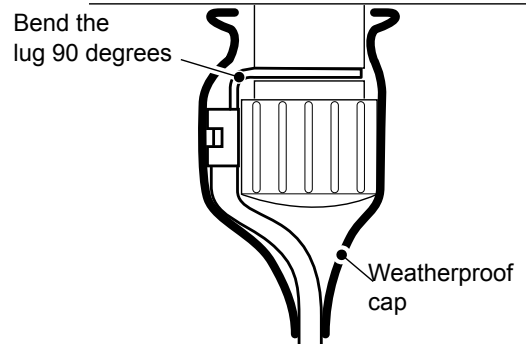

### • Attaching the DC power cable ferrite EMI filter

The DC power cables should be connected to the transceiver's main unit through the supplied ferrite EMI filter, as shown below. The ferrite EMI filter must be placed as near as possible to the main unit.

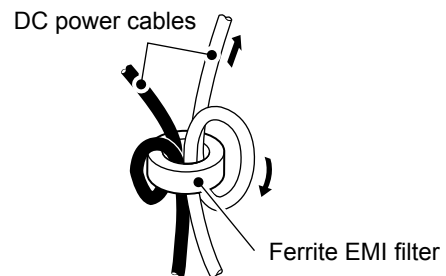

## Antenna

Most stations operate with a whip or long wire antenna. However, those antennas cannot be connected directly to the transceiver since their impedance will not match the transceiver's impedance. Use the AT-141 to connect antennas. For details about antenna connections and installation, see the supplied AT-141 Instruction manual.

**⚠ DANGER! HIGH VOLTAGE!** NEVER touch the antenna element or wire while tuning or transmitting.

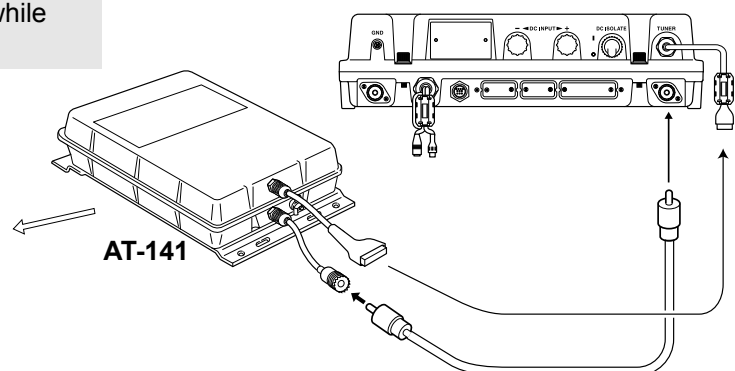
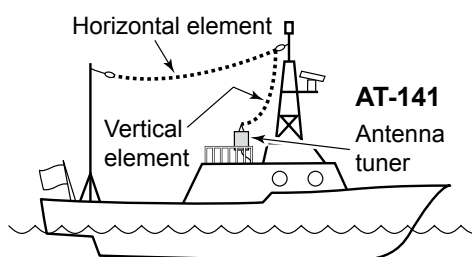

## ■ Mounting

### ◇ Mounting location

Select a location that provides easy access to the remote controller for navigation safety, has good ventilation and is not exposed to sea spray. The remote controller should be at 90 degrees to your line of sight when operating it.

**NOTE: BE SURE** to turn OFF [DC ISOLATE] on the GM800 main unit when mounting the transceiver.

Adjust the display angle to be easy-to-read.

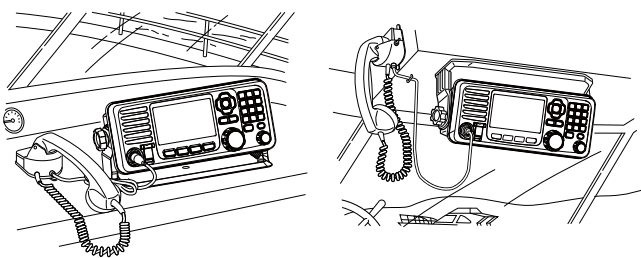

Put the supplied Emergency frequency sticker to where you can always see when operating the transceiver.

■ Emergency frequency list			
	Radiotelephone (User CH)	DSC (Digital Selective Calling)	Radiotelex
MF	2182kHz (CH 1)	2187.5kHz	2174.5kHz
HF4	4125kHz (CH 2)	4207.5kHz	4177.5kHz
HF6	6215kHz (CH 3)	6312.0kHz	6268.0kHz
HF8	8291kHz (CH 4)	8414.5kHz	8376.5kHz
HF12	12290kHz (CH 5)	12577.0kHz	12520.0kHz
HF16	16420kHz (CH 6)	16804.5kHz	16695.0kHz

■ Emergency operation	
Sending a Distress call	Sending a Distress Cancel call
1. Lift up the key cover of [DISTRESS]. 2. Hold down [DISTRESS] for 3 seconds to send the Distress call.	1. When "Waiting for ACK" is displayed, push [Cancel]. 2. Push [Continue] to send the Distress Cancel call.

■ DSC call operation	
1. Push [Compose Distress], [Compose Non-Distress], or [Compose DROBOSE] and enter the required information. 2. Push [Call] to transmit a DSC call.	

### ◇ Mounting the remote controller

Mount the remote controller using the supplied mounting bracket kit.

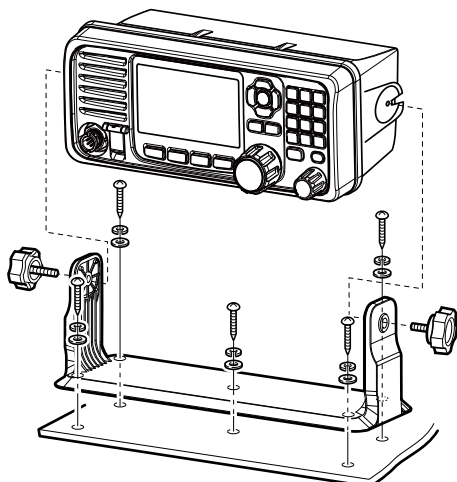

### ◇ Attaching the mounting plates

1. Attach the supplied rubber feet to the mounting plate, if desired.

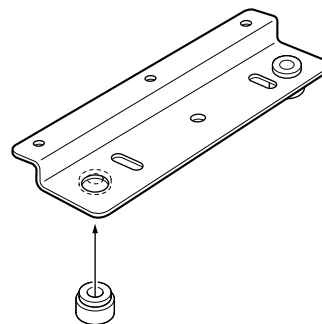

2. Attach the mounting plates using the supplied hex head bolts (M6×15), flat and spring washers, as shown below.

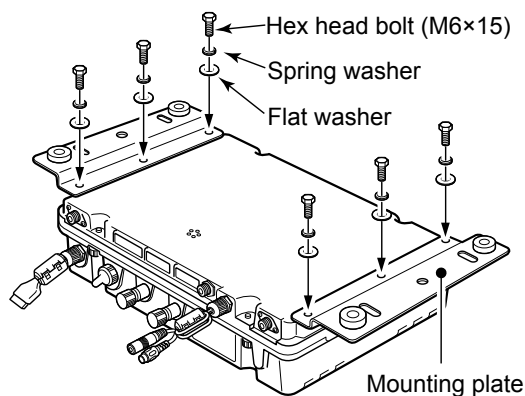

### ◇ Mounting the main unit

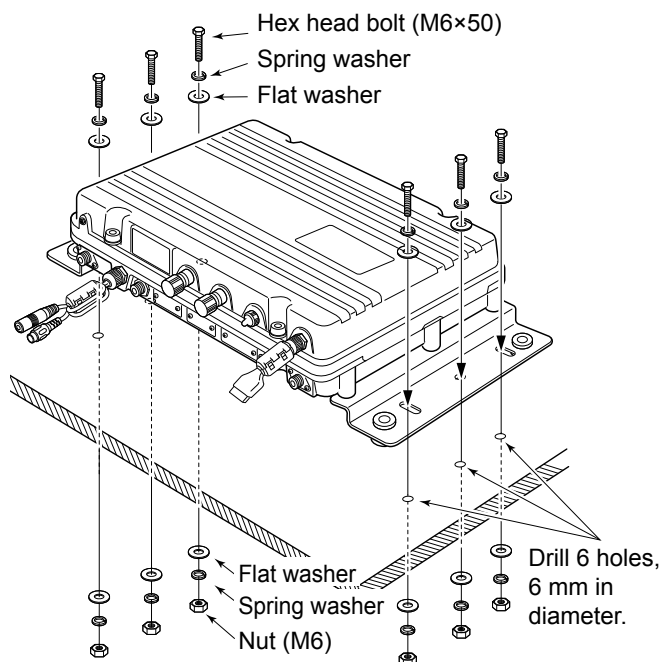

## ■ Using the optional MB-108

The optional MB-108 mounting bracket can be used to mount the transceiver's main unit. The MB-108 provides one-touch attachment or detachment.

**CAUTION:** Wear gloves when installing the MB-108. The edges of the MB-108 may be sharp and may easily cut your fingers or hands.

1. Attach the mounting handles with the supplied hex head bolts (M6×15), spring and flat washers, as shown below.

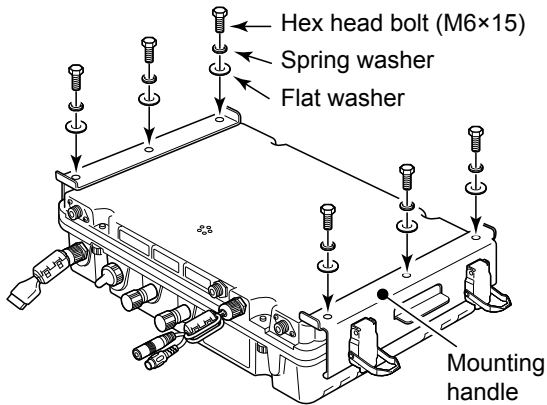

2. Drill 7 holes, 6 ~ 8 mm in diameter, using the template supplied with the MB-108.
3. Attach the mounting base to a flat surface using the hex head bolts (M6×50), spring and flat washers, and nuts, supplied with the MB-108, as shown below.

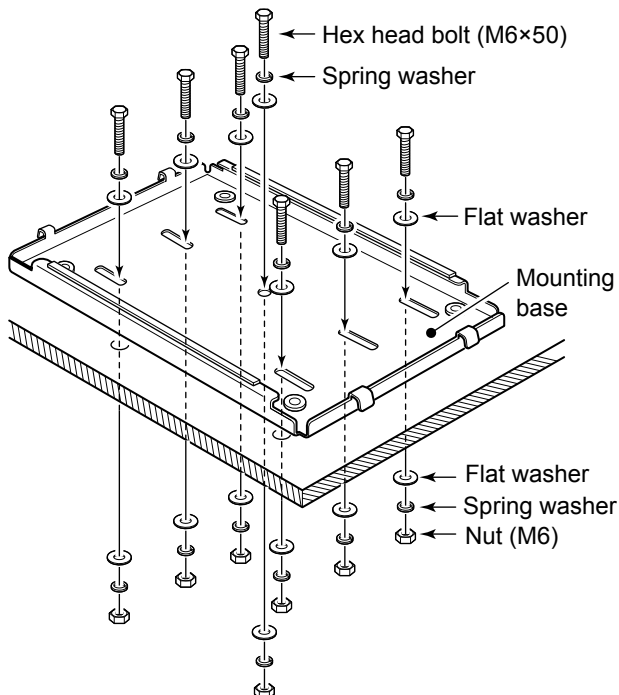

4. Mount the transceiver main unit with the mounting handles attached, to the mounting base.

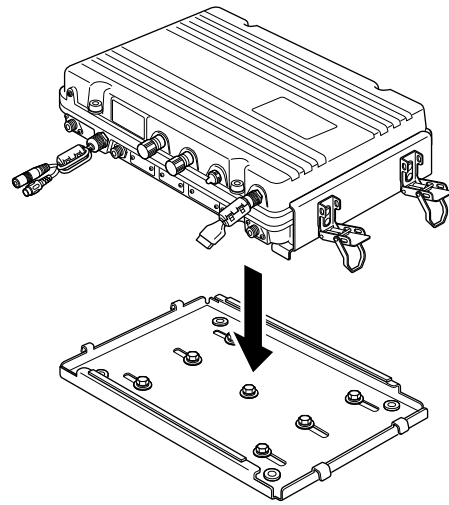

5. Lock the main unit in place by closing the 4 latches on the mounting handles.

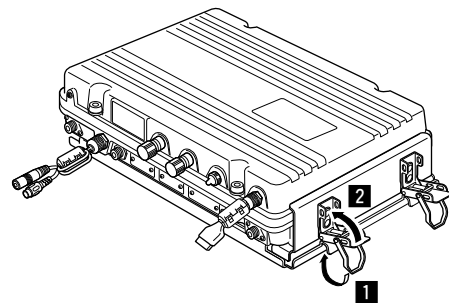



## ■ Replacing fuses

The transceiver has 2 fuses to protect internal circuitry.  
 If the transceiver stops functioning, and only after confirming a fuse is probably blown, check the fuses below.

- DC-DC converter unit ..... FGB 5 A
- PA unit ..... FGB 5 A

1. Unscrew 4 cap bolts from the top case. Use a 6 mm Allen wrench.

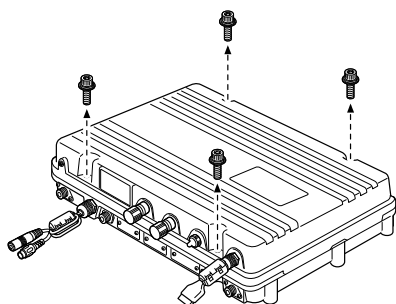

2. Open the transceiver's main unit, then disconnect 1 flat and 2 coaxial cables, as shown below.

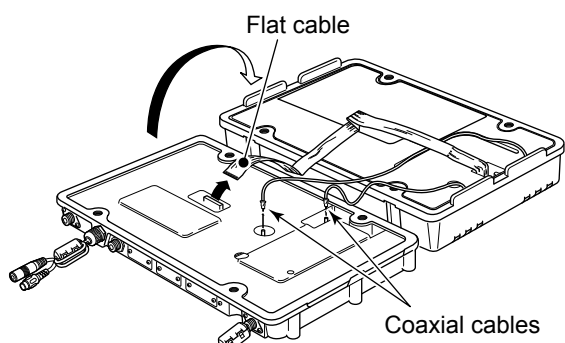

3. Unscrew the 26 screws from the shield covers, then open the covers.

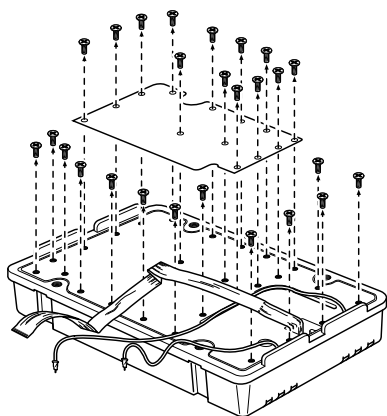

**CAUTION:** Disconnect the DC power cable from the transceiver before replacing a fuse.

4. Replace the circuitry fuse, as shown below. Use the supplied or same rated FGB 5 A fuse.

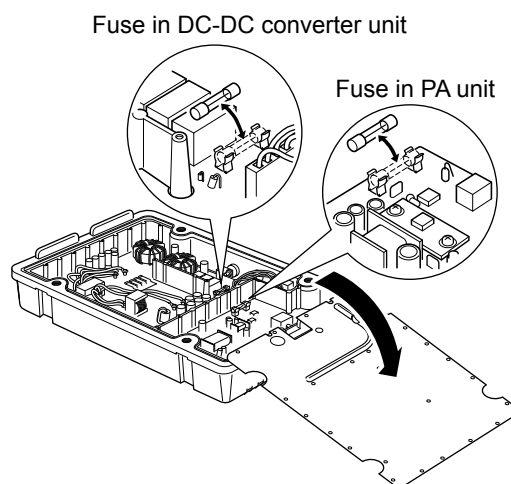

5. Reattach the shield covers, flat cable, coaxial cables and top case to their original position.

## ■ Connector information

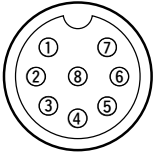
MICROPHONE	Pin	Pin name	Description	Specification
 <p>Front panel view</p>	1	MIC (+)	Audio input from the mic element.	Input impedance: 2.4 kΩ
	2	MIC SW	Key detection.	—
	3	AF1	AF output controlled by [VOL].	—
	4	AF2	Ground for AF1.	—
	5	PTT	PTT switch input. Transmits when grounded.	—
	6	GND	Connected to ground.	—
	7	MIC (-)	Coaxial ground for MIC (+).	—
	8	AF (-)	Coaxial ground for AF1 and AF2.	—

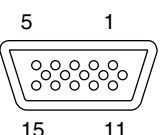
AF/MOD	Pin	Pin name	Description	Specification
 <p>Front panel view</p>	1~4	NC	<b>NOTE:</b> Do not connect to these pins.	—
	5	DSSW	Remote alarm input When connected to GND, the transceiver sends a Distress call. Can be used as an external Distress switch.	—
	6, 7	NC	<b>NOTE:</b> Do not connect to these pins.	—
	8	DSL D	Remote alarm output Connect external equipment such as a lamp or buzzer that needs a power source, between this pin and GND. When receiving a Distress call*, the key backlight blinks and the internal relay intermittently connects between this pin and GND.	Applicable voltage: Less than 30 V Current flow: Less than 1 A
	9, 10	GND	Ground	—
	11	MOD (+)	Modulation input from an external unit for the SSB.	Input impedance: 600 Ω Input level: Approximately 0.77 V rms
	12	MOD (-)	Coaxial ground for MOD (+).	Input impedance: 600 Ω
	13	AF (+)	AF detector output for an external unit for SSB.	Output impedance: 600 Ω Output level: 0.25 ~ 2.5 V rms
	14	AF (-)	Coaxial ground for AF (+).	Output impedance: 600 Ω
	15	SEND	Transmission control line for an external unit for SSB (transmits when grounded).	Output level: -0.5 ~ 0.8 V Input level: Less than 20 mA

\* A DSC call that is related to “Distress” as described below

- Distress call
- Distress acknowledgement
- Distress Relay call
- Distress Relay acknowledgement
- Distress Cancel call
- DSC call whose category is “Distress”

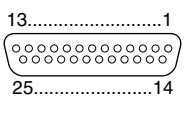
PRINTER	Pin	Pin name	Description
	1	STROBE	Outputs a strobe pulse after data output.
	2~9	DATA1~8	Outputs 8 bit parallel data.
	10	ACKNLG	Receives a 'Low' pulse from the printer when the printer can accept more data.
	11	BUSY	The printer sets this pin to 'High' when it can not accept data, such as when the printer is 'off line.'
	12~14	NC	<b>NOTE:</b> Do not connect to these pins.
	15	ERROR	The printer sets this pin to 'Low' when an error occurs, such as when the printer has no paper.
	16~17	NC	<b>NOTE:</b> Do not connect to these pins.
	18~25	GND	Ground terminals.

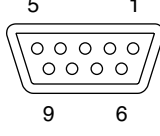
REMOTE	Pin	Pin name	Description	Specification
	1	DATA-OUT (-)	Ground for DATA-OUT (+) terminal.	-
	2	DATA-OUT (+)	IEC61162-1 Ed.4 (2010-11) data output.	Input level: 5V, 40mA maximum (at 2 V applied)
	3	DATA-IN (+)	IEC61162-1 Ed.4 (2010-11) data input.	Output level: Less than 2 mA (RS-422A balanced type)
	4	DATA-IN (-)	Ground for DATA-IN (+) terminal.	-
	5	GND	Connected to ground.	-
	6~9	NC	<b>NOTE:</b> Do not connect to these pins.	-

### ■ Transceiver dimensions

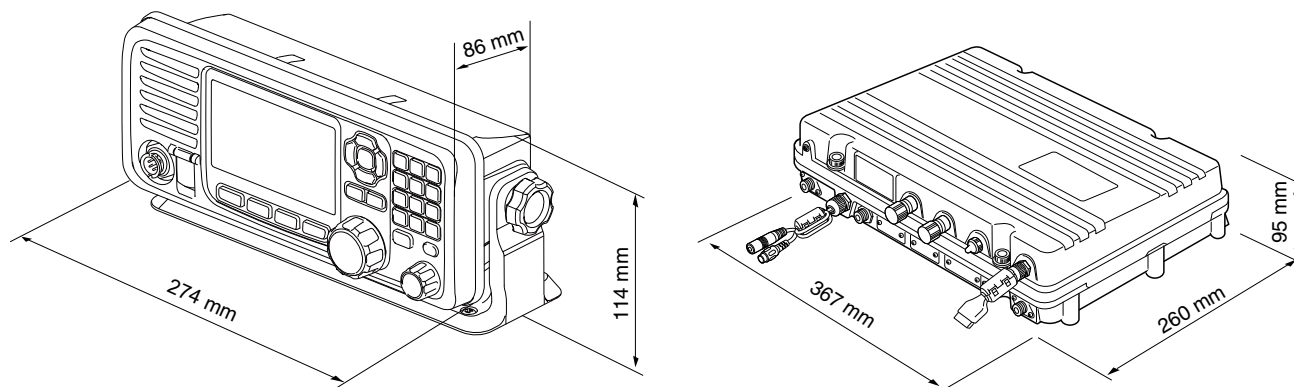

## ■ Specifications

### ◇ General

- Frequency coverage:
 

RX	0.5 ~ 29.9999 MHz
TX	1.6 ~ 2.9999 MHz, 4.0 ~ 4.9999 MHz 6.0 ~ 6.9999 MHz, 8.0 ~ 8.9999 MHz 12.0 ~ 13.9999 MHz, 16.0 ~ 17.9999 MHz 18.0 ~ 19.9999 MHz, 22.0 ~ 22.9999 MHz 25.0 ~ 27.5000 MHz
- DSC(RX)
 

	2.1875 MHz, 4.2075 MHz, 6.3120 MHz, 8.4145 MHz, 12.5770 MHz, 16.8045 MHz
--	--
- Mode:
 

RX/TX	J3E (USB), F1B (FSK)
RX only	J3E (LSB), J2B (AFSK), A1A (CW), H3E (AM)
- Antenna impedance:
 

	50 Ω (unbalanced)
--	-------------------
- Frequency stability:
 

	±10 Hz (after 30 minutes from turning ON the main power)
--	--
- Power supply requirement:
 

	21.6~31.2 V (24 V DC)
--	-----------------------
- Current drain (with 1.1 kHz and 1.7 kHz AF input):
 

RX	Less than 3 A (24 V) at Maximum audio output
TX	Less than 20 A (24 V) at Maximum output power
- Usable temperature range:
 

	-15 ~ +55°C
--	-------------
- Dimension (projections not included):
 

Main unit	367 (W) × 95 (H) × 260 (D) mm
Controller	274 (W) × 114 (H) × 86 (D) mm
- Weight:
 

Main unit	8.6 kg
Controller	760 g

**NOTE:** The usable temperature range of the antenna tuner AT-141 is different from the GM800. The range is -20 ~ +55°C.

### ◇ Transmitter

- Output power:
 

At radio terminal	150 W PEP into 50 Ω
At tuner output	1.6~3.9999 MHz 85 W PEP 4.0~27.5000 MHz 125 W PEP
- Spurious emissions (at Maximum power):
 

	43 dB below peak output power
--	-------------------------------
- Carrier suppression (at Maximum power):
 

	40 dB below peak output power
--	-------------------------------
- Unwanted sideband suppression (at Maximum power):
 

	55 dB below peak output power
--	-------------------------------

### ◇ Receiver

- RX/TX sensitivity:
 

J3E, A1A	0.5~1.5999 MHz 30 dBμV emf (20 dB SINAD)
	1.6~3.9999 MHz 16 dBμV emf (20 dB SINAD)
	4.0~29.9999 MHz 11 dBμV emf (20 dB SINAD)
J2B, F1B	1.6~2.0999 MHz 3 dBμV emf (1% error rate)
	2.1~27.5000 MHz 0 dBμV emf (1% error rate)
H3E	0.5~1.5999 MHz 44 dBμV emf (20 dB SINAD)
	1.6~3.9999 MHz 30 dBμV emf (20 dB SINAD)
- DSC sensitivity:
 

J2B	2.1875 MHz, 4.2075 MHz, 6.3120 MHz, 8.4145 MHz, 12.5770 MHz, 16.8045 MHz 0 dBμV emf (1% error rate)
-----	--
- Squelch sensitivity (S-meter):
 

J3E (at 12.230 MHz)	(Threshold) Less than +20 dBμV (Tight) Less than +90 dBμV
H3E (at 1.000 MHz)	(Threshold) Less than +30 dBμV (Tight) Less than +110 dBμV
- Spurious response rejection:
 

J3E	More than 60 dB (0.5~29.9999 MHz)
J2B	More than 90 dBμV emf
- Clarity variable range:
 

	±150 Hz
--	---------

## Options

The following items are sold as a set with the GM800.

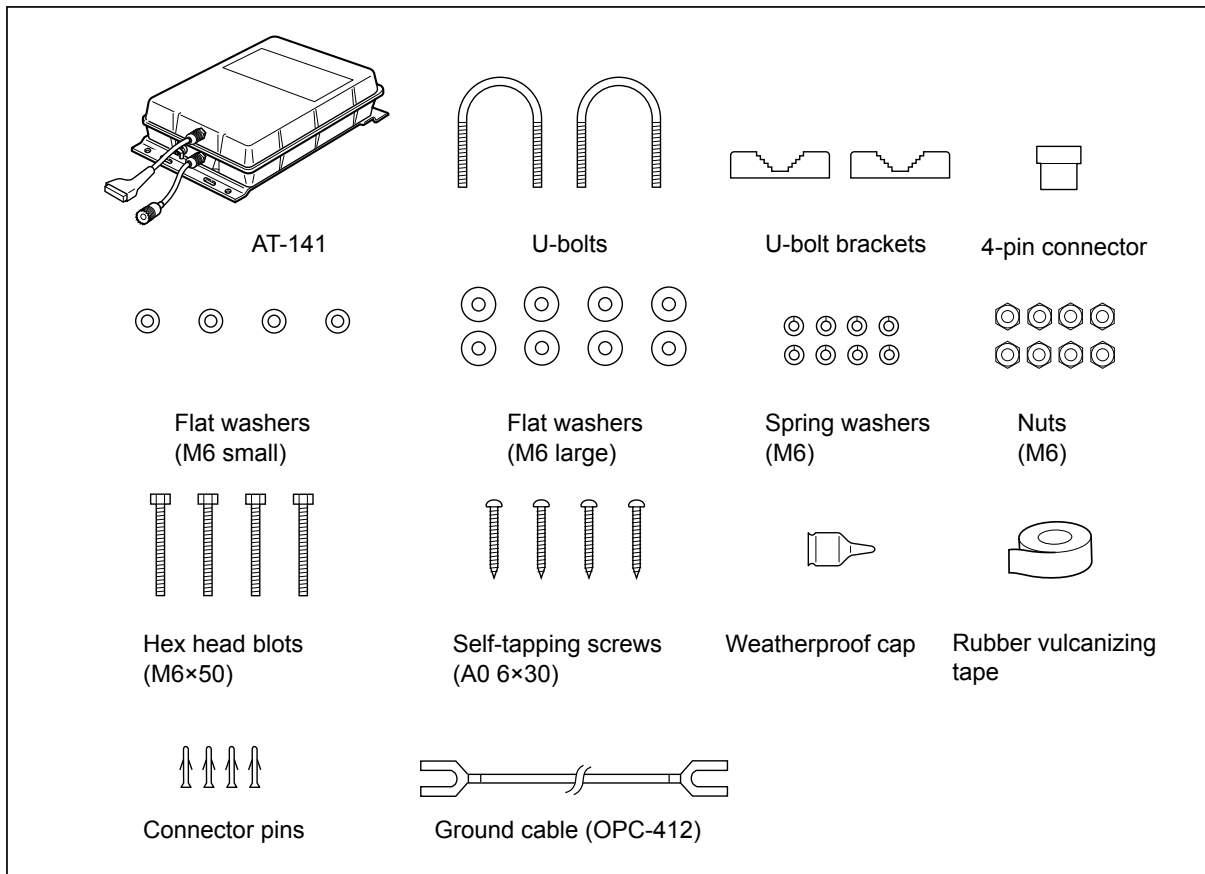

## Options

- **HS-98** HANDSET
- **HM-214H** MICROPHONE
- **SP-24E** EXTERNAL SPEAKER
- **OPC-1465** ATU CONTROL CABLE for the AT-141
- **MB-108** MOUNTING BRACKET to install the GM800 main unit

# 11 TROUBLESHOOTING

PROBLEM	POSSIBLE CAUSE	SOLUTION	REF.
The transceiver does not turn ON.	<ul style="list-style-type: none"> <li>• Bad connection to the power supply.</li> <li>• Fuse is blown.</li> </ul>	<ul style="list-style-type: none"> <li>• Check the connection to the transceiver and power supply.</li> <li>• Find the cause, repair, then replace the fuse.</li> </ul>	<p>p. 80</p> <p>p. 86</p>
Little or no sound comes from the internal speaker.	<ul style="list-style-type: none"> <li>• Squelch level is set too high.</li> <li>• Volume level is set too low.</li> <li>• The internal speaker is OFF.</li> </ul>	<ul style="list-style-type: none"> <li>• Set the squelch to the threshold point.</li> <li>• Set the volume to a suitable level.</li> <li>• Turn ON the internal speaker.</li> </ul>	<p>p. 15</p> <p>p. 3</p> <p>p. 5</p>
You cannot transmit.	<ul style="list-style-type: none"> <li>• Some channels are set for low power or receive only by regulations.</li> </ul>	<ul style="list-style-type: none"> <li>• Change channels.</li> </ul>	p. 11
No beep sounds.	<ul style="list-style-type: none"> <li>• The Key Beep function is OFF.</li> </ul>	<ul style="list-style-type: none"> <li>• Turn ON the Key Beep function.</li> </ul>	p. 77
The Main screen is not displayed at power ON.	<ul style="list-style-type: none"> <li>• MMSI (DSC self ID) code is not set.</li> </ul>	<ul style="list-style-type: none"> <li>• Set the MMSI (DSC self ID) code.</li> </ul>	p. 8
Individual or Group ID cannot be set.	<ul style="list-style-type: none"> <li>• The entered ID code is incorrect. The first digit must be set to between '1' and '9' for an Individual ID. The first digit must be set to '0' for a Group ID.</li> </ul>	<ul style="list-style-type: none"> <li>• Enter a correct ID code.</li> </ul>	p. 23
"??" blinks instead of the position data and time.	<ul style="list-style-type: none"> <li>• 4 hours have passed after you manually entered the position data.</li> <li>• The GPS position data is invalid.</li> </ul>	<ul style="list-style-type: none"> <li>• Enter the current position data.</li> </ul>	p. 27
"NO POSITION" and "NO TIME" are displayed instead of the position data and time.	<ul style="list-style-type: none"> <li>• A GPS receiver is not correctly connected.</li> <li>• The position data and time have not been manually entered.</li> </ul>	<ul style="list-style-type: none"> <li>• Check the GPS receiver connection.</li> <li>• Enter the current position data and time.</li> </ul>	<p>p. 80</p> <p>p. 27</p>
Sensitivity is too low, and only strong signals can be heard.	<ul style="list-style-type: none"> <li>• The antenna is defective or the coaxial cable connector is shorted or cut.</li> </ul>	<ul style="list-style-type: none"> <li>• Repair the problem and then reconnect to the antenna connector.</li> </ul>	p. 82
The communication cannot be established	<ul style="list-style-type: none"> <li>• The antenna is defective or the coaxial cable connector is shorted or cut.</li> </ul>	<ul style="list-style-type: none"> <li>• Repair the problem and then reconnect to the antenna connector.</li> </ul>	p. 82
The received DSC call content is not printed out.	<ul style="list-style-type: none"> <li>• The printer is not correctly connected, or the paper supply is exhausted.</li> </ul>	<ul style="list-style-type: none"> <li>• Check the printer connection or add paper.</li> </ul>	p. 80
"The transceiver cannot receive or transmit. Contact your dealer." is displayed.	<ul style="list-style-type: none"> <li>• The transceiver's Phase Lock Loop is unlocked.</li> </ul>	<ul style="list-style-type: none"> <li>• Contact your dealer.</li> </ul>	—
The transceiver is locked up, and does not respond.	<ul style="list-style-type: none"> <li>• A software error has occurred.</li> </ul>	<p>—</p> <p>(The transceiver will automatically restart after approximately 10 seconds has passed.)</p>	—

## ■ I/O Sentences

### ◇ Version number

IEC61162-1 Ed.4(2010-11)

### ◇ GPS Input sentences (IEC 61162-1)

GGA, GLL, GNS, and RMC

### ◇ GPS Input sentence description

#### • GGA—Global positioning system (GPS) fix data

\$-GGA,hhmmss.ss,llll.ll,a,yyyy.yy,a,x,xx,x.x,x.x,M,x.x,M,x.x,xxxx\*hh<CR><LF>

1      2 3 4      5 6 7 8 9 10 11 12 13 14

1	UTC of position (000000.00 to 235959.99)	8	Horizontal dilution of precision (no use)
2	Latitude (0000.0000 to 9000.0000)	9	Antenna altitude above/below mean sealevel (no use)
3	N/S	10	Unit M
4	Longitude (00000.0000 to 18000.0000)	11	Geoidal separation (no use)
5	E/W	12	Unit M
6	GPS quality indicator (1 to 5)	13	Age of differential GPS data (no use)
7	Number of satellites in use (no use)	14	Differential reference station ID (no use)

#### • GLL—Geographic position—Latitude/longitude

\$-GLL,llll.ll,a,yyyy.yy,a,hhmmss.ss,A,a\*hh<CR><LF>

1 2 3 4      5 6 7

1	Latitude (0000.0000 to 9000.0000)	5	UTC of position (000000.00 to 235959.99)
2	N/S	6	Status (A=data valid, V= data invalid)
3	Longitude (00000.0000 to 18000.0000)	7	Mode indicator (A=Autonomous, D=Differential, N=No fix, S= Simulator mode)
4	E/W		

#### • GNS—GNSS fix data

\$-GNS,hhmmss.ss,llll.ll,a,yyyy.yy,a,c--c,xx,x.x,x.x,x.x,x.x,x.x,a\*hh<CR><LF>

1      2 3 4      5 6 7 8 9 10 11 12 13

1	UTC of position (000000.00 to 235959.99)	8	HDOP (no use)
2	Latitude (0000.0000 to 9000.0000)	9	Antenna altitude, meters (no use)
3	N/S	10	Geoidal separation, meters (no use)
4	Longitude (00000.0000 to 18000.0000)	11	Age of differential data (no use)
5	E/W	12	Differential reference station ID (no use)
6	Mode indicator (N=No fix, A=Autonomous, D=Differential, P=Precise, R=Real Time Kinematic, F=Float RTK, S=Simulator mode)	13	Navigational status indicator (no use)
7	Total number of satellites in use (no use)		

#### • RMC—Recommended minimum specific GNSS data

\$-RMC,hhmmss.ss,A,llll.ll,a,yyyy.yy,a,x,x,xxxxxx,x.x,a,a\*hh<CR><LF>

1      2 3 4      5      6 7 8      9      10 11 12 13

1	UTC of position fix (000000.00 to 235959.99)	8	Course Over Ground, degrees True (0.0 to 360.0)
2	Status (A=data valid, V=navigation receiver warning)	9	Date (010100 to 311249)
3	Latitude (0000.0000 to 9000.0000)	10	Magnetic variation, degrees (no use)
4	N/S	11	E/W
5	Longitude (00000.0000 to 18000.0000)	12	Mode Indicator (A=Autonomous, D=Differential, F=Float RTK, N=No fix, P=Precise, R=Real Time Kinematic, S=Simulator mode)
6	E/W	13	Navigational status indicator (no use)
7	Speed over ground, knots (0.0 to 100.0)		

■ I/O Sentences

◇ Remote Input and Output sentences (IEC 61162-1)

Input: FSI (Set or Query),  
Output: FSI (Query receive), DSC (DSC receive), DSE (DSC receive)

◇ Remote sentence description

• FSI—Frequency set status or command

\$--FSI,xxxxxx,xxxxxx,c,x,a\*hh<CR><LF>  
          1      2      3 4 5

1	Transmitting frequency	3	Mode of operation
2	Receiving frequency	4	Power level
		5	Sentence status flag R= Sentence is a status report of current settings (use for a reply to a query). C= Sentence is a configuration command to change settings.

• Query sentence

\$--CTQ,FSI\*hh<CR><LF>  
→ \$CTFSI,xxxxxx,xxxxxx,c,x,R\*hh<CR><LF>

• DSC – Digital selective calling information

\$CTDSC,xx,xxxxxxxxxx,xx,xx,xx,x,x,x,x,xxxxxxxxxx,xx,a,a\*hh<CR><LF>  
          1      2      3 4 5 6 7      8      9 10 11

1	Format Specifier (2 digits)	7	Time or Tel. No (Maximum 16 digits)
2	Address (10 digits)	8	MMSI of ship in distress (10 digits or NULL)
3	Category (2 digits or NULL)	9	Nature of Distress (2 digits or NULL)
4	Nature of Distress or First Telecommand (2 digits or NULL)	10	Acknowledgement (R=Acknowledge request, B=Acknowledgement, S=Neither (end of sequence ))
5	Type of Communication or Second Telecommand (2 digits)	11	Expansion indicator (E or NULL)
6	Position or Channel/Frequency (Maximum 16 digits)		

• DSE – Expanded Digital Selective Calling

\$CTDSE,x,x,a,xxxxxxxxxx,xx,c--c,.....,xx,c--c\*hh<CR><LF>  
          1 2 3      4      5 6      7      8 9

1	Total number of sentences (fixed value)	6	Data set '1' (code field, Enhanced position resolution, Maximum 8 characters), NULL
2	Sentence number (fixed value)	7	Additional data sets*1, NULL
3	Query/Reply flag (fixed value A=Automatic)	8	Data set 'n' (NULL)*1
4	Vessel MMSI (10 digits)	9	Data set 'n' (NULL)*1
5	Data set '1' (code field, fixed value 00)		

\*1 This transceiver outputs only "Data set 1."



■ Schematic diagram

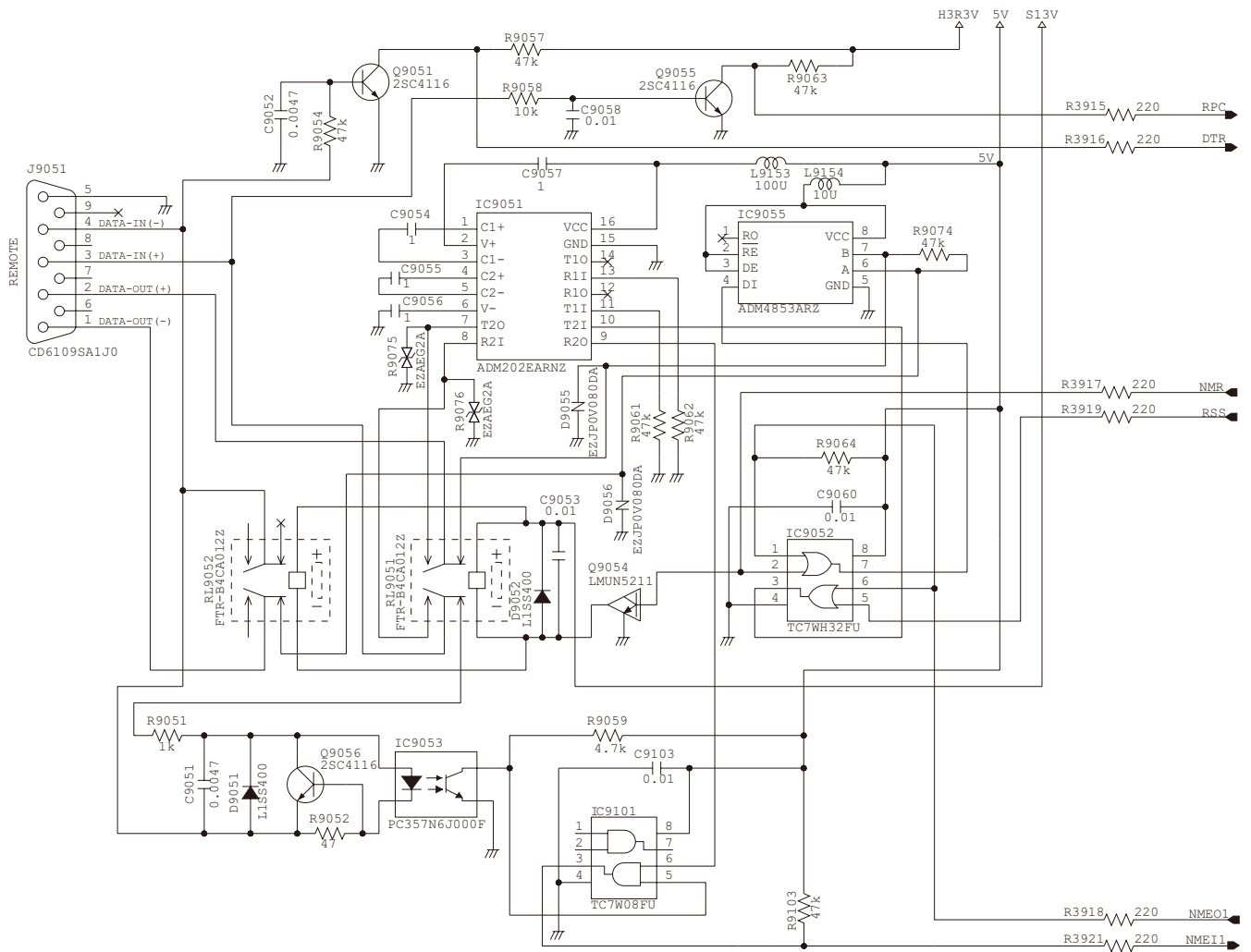
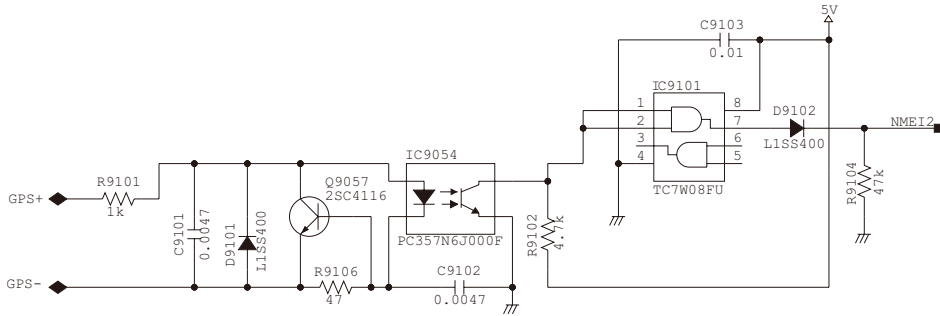

## ■ Hardware version

The transceiver's hardware version is described on the serial number label, as shown to the right.

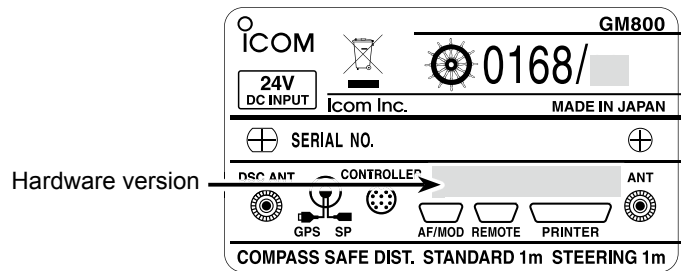

## ■ Software version

You can confirm the transceiver's software version in the Menu screen.

1. Push [MENU].
2. Select "Configuration."

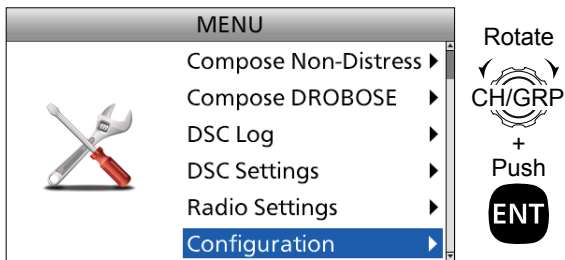

3. Select "Software Version."

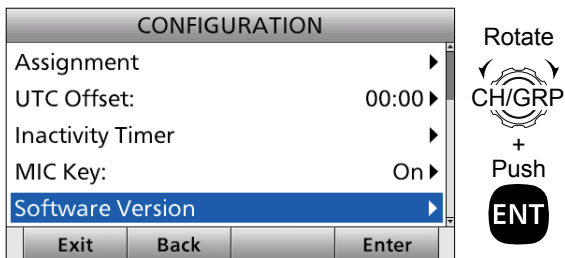

4. The transceiver's version and the front panel's software version are displayed.

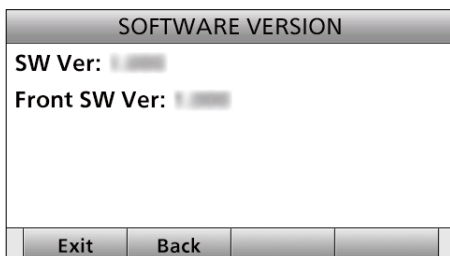

Accessories .....	78	Group		Position Request call	
AGC .....	16	Selecting .....	11	Sending .....	50
Antenna .....	81	Group call		Position Request Call	
AT-141 .....	81	Receiving .....	63	Receiving .....	65
Automatic acknowledgement .....	71	Sending .....	45	Power source .....	81
Automatic Antenna Tuner function .....	16	Group ID		Precautions .....	ii
Automatic Gain Control OFF .....	16	Deleting .....	26	Reassigning	
Backlight .....	13	Entering .....	25	Software Key function .....	20
Call log		Hand microphone .....	4	Receiving .....	12
Received .....	69	Handset .....	4	RF gain level .....	16
Transmitted .....	69	HM-214H .....	4	Scan .....	14
Channel		Individual acknowledgement		Schematic diagram .....	92
Selecting .....	11	Receiving .....	61	Ships and Aircraft call	
Clarity Control function .....	16	Sending .....	45	Receiving .....	68
Connections		Individual call		Sending .....	54
Advanced .....	79	Receiving .....	61	S-meter squelch level .....	15
Basic .....	78	Sending .....	43	Software Key	
Connector information .....	85	Individual ID		Active .....	29
Digital interface .....	90	Deleting .....	26	AGC × .....	5
Dimensions .....	86	Entering .....	23	Backlight .....	5
Display .....	6	Installation note .....	iii	Clarity .....	5
Channel and Frequency area .....	6	I/O Sentences .....	90	Compose Distress .....	5
Information area .....	6	ITU Simplex channel .....	18	Compose DROBOSE .....	5
Position Date and Time area .....	7	Main screen .....	6	Compose Non-Distress .....	5
Status area .....	6	Main unit .....	2	DSC Log .....	5
Task area .....	6	MB-108 .....	83	Hold .....	29
Disposal .....	iii	Medical Transports call		Mode .....	5
Distress acknowledgement		Receiving .....	67	NB .....	5
Receiving .....	58	Sending .....	54	NB Level .....	5
Sending .....	36	Menu		RF Gain .....	5
Distress call		Configuration		Scan .....	5
Re-sending .....	33	Assignment .....	76	SP × .....	5
Sending .....	30	Inactivity Timer .....	76	SQL .....	5
Regular call .....	31	Key Beep .....	76	S-SQL Level .....	5
Simple call .....	30	MIC Key .....	77	Task Mode .....	5
Distress Call		NMEA Data Output .....	76	TX Freq Monitor .....	5
Receiving .....	57	Software Version .....	77	Software maintenance .....	80
Distress Cancel call		UTC Offset .....	76	Specifications .....	87
Receiving .....	59	Radio Settings		Squelch function .....	15
Distress Cancel call, Sending .....	34	Auto Tune .....	75	Supplied accessories .....	78
Distress key .....	3	Max User CHAN .....	75	Temporary operating frequency .....	17
Distress Relay acknowledgement		Scan .....	75	Test acknowledgement	
Receiving .....	60	Voice SQL .....	75	Receiving .....	67
Sending .....	42	Menu items .....	75	Test call	
Distress Relay call		Menu screen		Receiving .....	66
Receiving .....	59	Construction .....	9	Sending .....	52
Sending .....	37	Selecting the item .....	10	Test call acknowledgement	
DROBOSE .....	37	MMSI code .....	8	Sending .....	53
DSC address ID .....	23	Modem socket .....	2	Time-out Timer (TOT) function .....	12
DSC Frequency .....	70	Mounting		Transmit Frequency Monitor function .....	15
DSC scan .....	12	Location .....	82	Transmitting .....	12
DSC Settings .....	70	Main unit .....	82	Trouble shooting .....	89
10 Second Delay .....	73	Plates .....	82	User channel .....	18
Alarm Status .....	73	Remote controller .....	82	Version	
Auto Print .....	74	Noise Blanker function .....	15	Hardware .....	93
Distress Scanning Receiver .....	72	Noise blanker level .....	15	Software .....	93
DSC Loop Test .....	74	Non-Distress calls .....	43	Weatherproof cap .....	81
Individual ACK .....	71	Operating rules .....	1		
Medical Transports .....	72	Options .....	88		
Ships and Aircraft .....	72	Panel description .....	2		
DSC Task mode .....	29	Polling Request acknowledgement			
Emergency .....	i	Sending .....	52		
Ferrite EMI filter .....	81	Polling Request call			
Fuses .....	84	Receiving .....	66		
Geographical Area call		Position and time			
Receiving .....	64	Entering .....	27		
Geographical call		Position Request acknowledgement			
Sending .....	47	Receiving .....	65		
Ground connection .....	80	Sending .....	51		

**Count on us!**

