

User Guide

STP8X000 hand-portable radio



Original Instructions: ENGLISH
Document Number: MOD-15-1892
Issue 9.0

Copyright

© Sepura Limited 2002–2020 All rights reserved.

No part of the information contained herein and the other referred documents may be copied, distributed or transmitted by any means to any other party without prior written permission of Sepura Limited. The distribution of this document may require a Non-Disclosure Agreement (NDA) between Sepura Limited and their agents or customers.

This document, the referred documents and the described product are considered protected by copyright according to the applicable laws.

Disclaimer

Although every reasonable effort has been made to ensure the accuracy of the information contained herein and any other referred document, this should not be construed as a commitment on the part of Sepura Limited and the liability of Sepura Limited for any errors and omissions shall be limited to the correction of such errors and omissions. Sepura Limited welcomes any comment and feedback as a way to improve any delivered documentation. The information contained herein has been prepared for the use of appropriately trained personnel, and it is intended for the purpose of the agreement under which the information is submitted. Any party using or relying upon this information assumes full responsibility for such use and in no event shall Sepura Limited be liable to anyone for especial, collateral, incidental, or consequential damages in connection with or arising out of the use of this information. The information or statements given in these documents regarding the suitability, capacity or performance of the mentioned hardware or software products cannot be considered binding but shall be defined in the agreement made between Sepura Limited and the customer. Sepura Limited reserves the right to revise these documents and to make changes to its content at any time, without prior notification.

Trademarks

The Sepura logo and some product branding logos and names are registered trademarks of Sepura Limited.

All other trademarks appearing in this document are the property of their respective owners.

Software license agreement

CAREFULLY READ THE LEGAL AGREEMENT CORRESPONDING TO THE LICENSE YOU PURCHASED, WHICH DESCRIBES THE GENERAL TERMS AND CONDITIONS FOR THE USE OF THE LICENSED SOFTWARE.

Contact Details

Sepura Limited
9000 Cambridge Research Park
Beach Drive
Waterbeach
Cambridge
CB25 9TL
United Kingdom

sepura.com

General information

This user guide describes the default operation and features of the STP8X000 radio. Your service provider or organisation may have customised your radio to optimise its performance to suit your individual needs. There may be differences between this guide and the way your product operates. Contact your service provider or organisation for information about the customisation of your radio.

Safety

Before operating the STP8X000 hand-portable radio, read the safety instructions contained in the **Product Safety Guide (SPR-DOC-00170)** supplied with the product.

Regulatory

European regulations

 Sepura declares that its TETRA radio products are compliant with the essential requirements and other relevant provisions of the European Radio Equipment Directive 2014/53/EU on the harmonisation of the laws of the Member States relating to the making available on the market of radio equipment and repealing Directive 1999/5/EC. These products are also compliant with directive 2011/65/EU having been designed and manufactured to the RoHS requirements.

Simplified EU declaration of conformity

Sepura declares that the radio equipment types SC21, SC20 and STP9000 series hand-portable radios and SRG3900/SCG22 mobile radio are in compliance with Directive 2014/53/EU. The full text of the EU declaration of conformity is available at the following internet address:
www.sepura.com/support/compliance-documents.

Waste Electrical and Electronic Equipment disposal information



This symbol on the product or its packaging indicates that this product must not be disposed of as household or commercial waste. Some countries have set up collection and recycling systems for waste electrical and electronic products. By ensuring that this product is disposed of correctly, you will help prevent potentially negative consequences for the environment and human health, and help conserve natural resources. Please dispose of your waste product according to your national and local regulations. Contact your service provider or Sepura for information on how to return this product for waste disposal.

Disposing of waste batteries



Sepura radios are supplied with a rechargeable battery. This symbol on the battery and its packaging indicates that it must not be disposed of with household or commercial waste. Please dispose of your waste batteries according to your national and local regulations. Contact your service provider or Sepura for advice on disposing batteries in your area of the world.

Federal Communication Commission (FCC) Regulations

Sepura TETRA radios generate, use and radiate RF energy. Radios that comply with the limits for a Class A digital device, pursuant of part 15 of the FCC rules are identified by an FCC certification ID label (located under the battery). Changes or modifications not expressly approved by the party responsible for compliance could void the user's authority to operate the equipment (rule part 15.21). This device complies with Part 15 of the FCC rules. Operation is subject to the following two conditions: (1) This device may not cause harmful interference, and (2) this device must accept any interference received, including interference that may cause undesired operation.

US and Canada Markets

FCC radiation exposure statement

This radio is intended for use in occupational/controlled applications where users have been made aware of the potential risks for exposure and can exercise control over their exposure. This product is not authorised for general population, consumer or similar use. This transmitter must not be co-located or operated in conjunction with any other antenna or transmitter.

IC RSS warning

The term "IC:" before the certification/registration number only signifies that the ISED technical specifications were met.

IC radiation exposure statement

This radio is intended for use in occupational/controlled applications where users have been made aware of the potential risks for exposure and can exercise control over their exposure. This product is not authorised for general population, consumer or similar use. This transmitter must not be co-located or operating in conjunction with any other antenna or transmitter.

CONTENTS

Safety	i
Regulatory	i
Your radio at a glance	1
Battery	3
Charging the battery	4
Charging a 'flat' battery	4
Fitting the battery	5
Removing the battery	5
Using Sepura approved batteries	6
Controls & indicators	7
Mode Key	7
Navi-knob	7
Navigation Keys	8
Soft keys	8
Context keys	9
Status icons	10
LED indicators	13
Emergency button	14
Getting Started	15
Antenna	15
Fitting a microSD card	16
Fitting a Smartcard	18
Power on	19
Power off	20
Locking and unlocking the keypad	20
Home screen	21
Shortcut Bar	22
Notifications	22
Menu	23
SmartMenus	24
Help	25
Emergency operation	26
Making an Alarm call	27
Receiving an Alarm call	27
Clearing an Alarm call	27
Sound	28
Adjusting the volume	28
Loudspeaker on/off	28
Muting all audio	28
Loudspeaker high/low audio mode	28

Whisper mode	29
Audible tone alerts	29
Personalising your radio	31
Invert the display	31
Adjusting the backlight	31
Adjusting text and icon size	32
Setting the display language	32
Menu style	33
Time and Date	34
Talkgroups and folders	35
Special folders	35
Talkgroup Selection Mode	37
Typical folder arrangement	38
Selecting a talkgroup	38
Folder Selection Mode	42
Contacts	50
Searching and filtering contacts	50
View contact details	51
Creating contacts	51
Editing contacts	52
Delete all contacts	53
Calls	54
Call types	54
Call History	55
Group calls	56
Individual calls	57
Broadcast calls	59
Missed events	59
Quick Calls	60
Smart Calls	60
Modifying your call setup	61
Changing the behaviour of the PTT during TMO group calls	62
Text entry	64
Cursor movement	64
Character sets	65
Messages	66
Message Inbox	66
Opening messages	67
View message details	67
Reply to a message	68
Saved messages	69
SDS report request	72
Picture messages	73

Paging alerts	73
Networks	74
Authentication	74
Change Network	74
Transmit Inhibit	75
Adjusting the DMO power transmission level	76
Fallback Mode	76
Operating Modes	77
DMO Mode	77
Repeater Mode	79
Callout alerts	83
Responding to Callouts	83
Callout display	87
Group calls to Callout group	89
Information Phase	90
Features	92
Privacy Screen	92
View images	92
User profiles	93
Man Down	94
Lone Worker	95
WAP	96
Using WAP	96
Browser menu	96
Navigation menu	97
Settings	98
History menu	99
Using bookmarks	100
Call handling	101
Location Services	103
Position	103
Direction	104
Reporting options	104
GNSS selection	104
Bluetooth®	105
Bluetooth® on/off	105
Audio devices	105
Data devices	107
Modify connected devices	109
Security	110
PIN entry	110
Change PIN	110

Unlocking the radio after incorrect PIN entry	110
End-to-End Encryption	111
Asset management	113
Labelling	113
Customising your radio	114
Revert radio settings to customisation settings	114
Accessories	116
Accessory profiles	116
Belt clip	117
Klick fast stud	119
Fit an accessory	120

Your radio at a glance

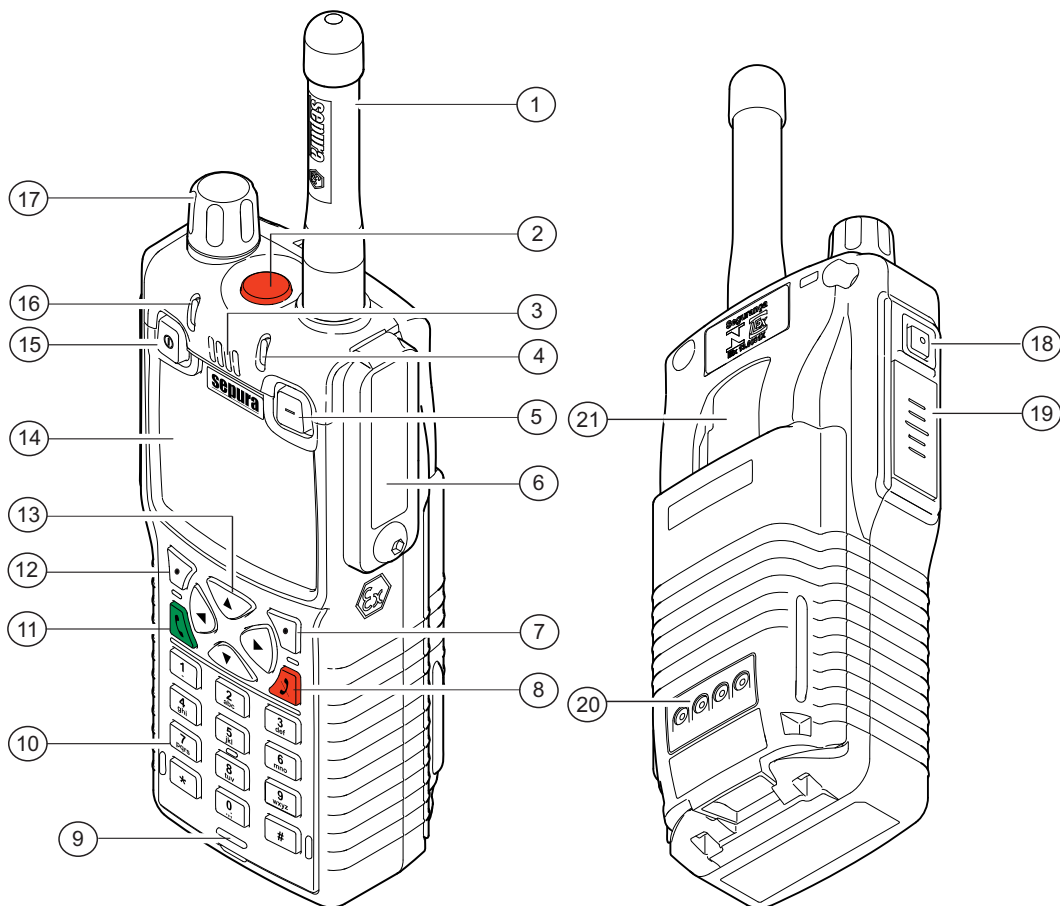

Item	Description
1	Antenna.
2	Emergency Button. Press and hold (2 seconds) to initiate an Alarm Call.
3	Earpiece and microphone. Earpiece is active during full-duplex calls when the radio is held like a mobile phone against the ear. Speak into the microphone during half-duplex calls when the radio is not attached to an audio accessory and held in the hand.
4	Blue LED (indicator). Indicates a missed event such as a call, Callout or message. Also indicates Bluetooth® status.
5	Missed Events soft key. Press to open the Missed Events menu to review missed calls, Callouts and new messages.
6	Rugged Side Connector (RuSC). Connection of audio accessories. Also used to program the radio.
7	Right context key. Press to activate the feature or option that appears directly above the key.
8	Red (Cancel/Home) key. Press to cancel a function or a call. Press and hold (2 seconds) to return to the Home screen.
9	Microphone used during phone calls when the radio is held like a phone.
10	Alphanumeric keypad with backlight, and Loudspeaker and microphone behind. The loudspeaker is used during half-duplex calls when an audio accessory is not connected and the radio is held in the hand. The microphone is used during full-duplex calls. Use the keypad to enter alphanumeric characters for text editing and dialling. Keys 0–9, # and * are programmable soft keys.
11	Green (Select/Send) key. Press to initiate a half-duplex individual call or a full-duplex call. Press to select a menu item or action a function, or send a status or text (SDS) message.
12	Left context key. Press to activate the feature or option that appears directly above the key.

- 13 **Navigation keys.** Scroll through lists. Move the cursor when writing text.
- 14 **Colour display** with backlight.
- 15 **Mode/Power key.** Press and hold (2 seconds) to power **on**. Press and hold (4 seconds) to power off. Press to quickly access talkgroups, status messages and user profiles from the Home screen.
- 16 **Tri-colour LED** (indicator). Indicates various operational states of the radio.
- 17 **Navi-knob.** Rotate to adjust the speaker volume.
- 18 **Soft key.** Press to activate a programmed feature.
- 19 **PTT (Press-to-talk key).** Press and hold to talk during a group call. Release to listen to other radio users.
- 20 **Battery release.** Press to release the battery.
- 21 **Battery charge contacts.**
- 22 **Accessory attachment point** for Klickfast accessories such as a belt clip or other accessory designed for securing the radio during use.

Battery

For your safety, inspect the battery regularly for any signs of damage, such as cracks or surface damage caused by an impact or the battery being dropped. Fit a new battery if there are any signs of damage.



Warning! Risk to personal Safety. Only fit a Sepura approved intrinsically safe battery to an STP8X series radio. Fitting of a non-approved battery may damage the product, will result in non-compliance with regulatory requirements and safety ratings, compromise the product safety ratings including SARS, reduce the length of operating time and will invalidate the product warranty.

Checking the battery charge

Always check the amount of battery charge before lengthy periods of operation. A fully charged battery should provide continuous operation for a full shift, depending on a number of operational factors such as how the radio is operated, the operating environment (temperature and network signal strength) and the condition of the battery. When the radio is powered on, the amount of charge remaining may be displayed as a percentage (%) on the screen.

Battery charge indicators

A battery meter and a battery icon appear on the left-hand side of the Home screen. The meter consists of 8 segments that fill and empty corresponding to the amount of battery charge .

Icon	Description
	Battery is fully charged.
	Battery has >37% charge remaining.
	Battery has >12% charge remaining.
	Battery is low, less than 12% remaining.

The mechanism for measuring the remaining charge in the battery may become inaccurate over time. To avoid this, periodically run the battery flat in normal use (so that your radio automatically powers down) and then re-charge the battery fully without disconnecting it from the charger.

Optimising battery life

A fully charged battery should last a full shift (approximately 12 hours) but this depends on a number of operational factors, such as how the radio is operated, the operating environment (temperature and network signal strength) and the condition of the battery.

Try the following to help you optimise battery life on a daily basis:

- Ensure that batteries are fully charged at the start of a shift.
- Decrease the amount of time the backlight stays lit between key presses (see **Adjusting the backlight** on page 31).
- Keep your speaker audio volume to a minimum (see **Adjusting the volume** on page 28).
- Reduce the length of time the radio is transmitting and keep DMO or telephone type calls to a minimum because they cause higher current consumption.
- Shorten the GPS reporting intervals if enabled (see **Reporting options** on page 104).

Charging the battery

Your radio is powered by a rechargeable battery. The battery may be recharged many times but it will eventually need replacing to ensure continuous maximum performance from your radio.

Battery chargers

Only use Sepura approved battery chargers. Use of non-approved chargers may not fully charge the battery or damage it. Always read the user documentation supplied with the charger for additional safety instructions and how to use it.

Using non-approved chargers will invalidate the intrinsically safe ATEX/IECEx safety compliance ratings of your radio.

Charging methods

The radio may be powered on or off during charging.

Place the radio with battery attached into the charging dock.

The battery may be charged separately from the radio using a battery-only charger.

Charging a 'flat' battery

If the battery is completely 'flat' (without charge) during storage or after a long period of non-activity, it may fail to recharge or stop charging after 20 minutes. If this happens, disconnect and then reconnect the charger (or power off the charger, then power on) to reset the battery.



NOTE: Do not charge a flat battery attached to the radio. During charging, the radio will attempt to power on when the battery charge reaches a certain capacity, which will continually drain the battery of its charge. Always charge a flat battery with the radio powered off or using a battery charger.

Fitting the battery

Ensure that the Smart/microSD card compartment cover is securely latched before fitting the battery.



Warning! Caution! If a Belt clip or Shirt/Pocket clip is fitted to the radio, lift the Belt clip or Shirt/Pocket clip before attempting to fit the battery. Do not attempt to insert the battery into the battery compartment sideways under the clip. This may result in damage to the radio and the belt clip.

To fit the battery, insert the battery into the battery compartment as shown. Hold the battery release, and press downwards until it clicks into place.

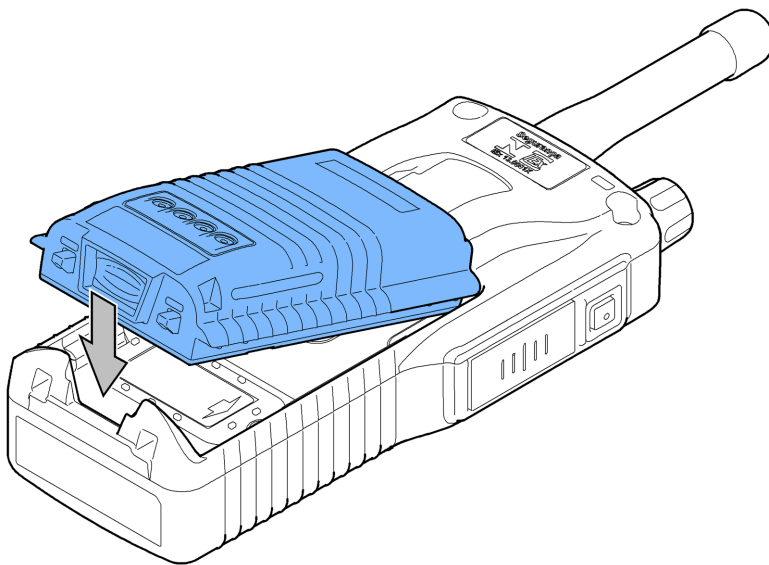

Removing the battery

Power off before removing the battery.

Caution! Risk of damage to the radio. If a Belt clip or Shirt/Pocket clip is fitted to the radio, lift the Belt clip or Shirt/Pocket clip before attempting to remove the battery. Do not attempt to remove the battery from the battery compartment sideways under the clip. This may result in damage to the radio and the belt clip.

Push the safety latch on the bottom of the battery. Lift the battery upwards and remove.

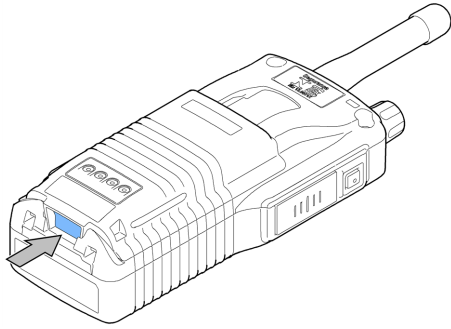

Using Sepura approved batteries

When the radio is powered on, it checks the authenticity of the battery. There are a number of battery management features that only work when a genuine Sepura battery is fitted to the radio, including:

- the remaining battery charge appears as a percentage when your radio is powered on [customisable];
- battery meter icons, showing the remaining battery charge;
- a low battery warning appears when charge is low; and
- allowing the user to check the battery information, such as its authenticity, remaining charge and serial number [customisable].

If a non-approved battery is used, the radio displays a warning message when powered on. Press any key to clear the message.

Caution! Risk of damage to the radio. Non-approved batteries may not have inbuilt safety protection features, and could potentially damage the radio (invalidating any product warranty) and affect the radio's safety and IP compliance ratings.

Getting information about your battery

You can view information about the battery attached to the radio, such as the remaining battery charge, whether the battery is authenticated (a genuine Sepura battery) and the battery serial number [customisable].

Select **Menu > Options > Battery Information**.

The display shows:

- **Charge**—the current remaining charge given as a percentage
- **Authenticated/Unauthenticated**—a Sepura/non-Sepura battery is fitted
- **serial number**—the serial number of the battery

If a non-Sepura battery is fitted, the **Charge** is reported as 0%, the battery is marked as **Unauthenticated** and the serial number is not shown.

Controls & indicators

Your radio has a number of controls and indicators.

Mode Key

Use the Mode key to quickly perform the following functions. The Mode key is also used in conjunction with the Navi-knob.

To do this...	Do this...
Power on	Press the Mode key (2 seconds)
Power off	Press and hold (4 seconds) the Mode key then follow screen instructions.
Navigate through available Talkgroups*	Press the Mode key, then rotate the Navi-knob to choose a talkgroup. Press the Select key to attach to the talkgroup.
Navigate through available Status messages*	Press the Mode key 2 times, then rotate the Navi-knob to choose the message. Press the Send key to send the message.
Navigate through available User Profiles*	Press the Mode key 3 times, then rotate the Navi-knob to choose the profile. Press the Send key to confirm selection.



NOTE: *Depending on customisation, any combination of the Groups, Status or Profiles options may be disabled and not available for selection.

- If an option is disabled, the Quick Change Menu is still presented in order with the disabled element being skipped
- If all the options are disabled, short pressing the Mode key has no effect
- If only one option is available, short pressing the Mode key has no effect when the only available option is selected

Navi-knob

The Navi-knob is a continuous rotating knob that in its normal mode is used to adjust the volume. The Navi-knob can also be used to perform various other functions.

To do this...	Do this...
Adjust loud speaker volume (or enable/disable Whisper Mode [customisable])	Rotate Navi-knob
Move cursor and select characters (in text entry mode)	Rotate Navi-knob in Text Entry Mode or Editing Mode

Scroll through available Talkgroups*	Press the Mode key + rotate the Naviknob
Scroll through available Status Messages*	Press Mode key 2 times + rotate Naviknob
Scroll through available User Profiles*	Press Mode key 3 times + rotate Naviknob



NOTE: *Depending on customisation, any combination of the Talkgroups, Status Messages or User Profiles options may be disabled and not available for selection.

Navigation Keys

Your radio has four navigation keys (left/right/up/down).

Key	Action
Up/Down	Use to move the scroll bar up and down to see more information. Scroll a list of options. To independently adjust the volume of accessories. See Independent volume control feature on page 1.
Down	Open the top level menu from the Home screen.
Up	Repeated presses moves upwards through the options and menu levels until the top level menu is reached.
Left/Right	Moves between options on the top level menu. Moves through the text characters for selection when writing.



NOTE: When the display is inverted (flipped upside down) the left and right navigation keys work in opposite directions.

Soft keys

Some keys on your radio may be customised to provide one-touch access to regularly used features. These programmable keys are referred to as *soft keys*.

To activate the soft key function:

- assigned to a programmable soft key, press and release
- assigned to other keys (such as the keypad, **Cancel/Home** and **Select/Send** keys), press and hold for one second

The following keys can be customised as soft keys:

- the **Select/Send** key
- the **Cancel/Home** key
- the Emergency Button (if not assigned to Emergency operation)
- the programmable side buttons
- the left and right navigation keys
- all radio keypad keys (1–9, *, 0, #,)



NOTE: During full-duplex PSTN/PBX calls, take care when trying to activate soft keys (designated as 0–9, * and # keys) because they also generate DTMF tones.

There are many functions that can be assigned to a Soft key. Some functions are activated immediately, such as the keypad lock/unlock or loudspeaker on/off. There are some special functions that use a 'navigate to screen' function. This means that on activation, a screen displays and you need to take some additional action, such as activating a SmartMenu where you have to select an option.

Context keys

Your radio has a left and right *context key* which you use to select options displayed adjacent to them.

On the Home screen the function assigned to each context key is defined during customisation. You can change the soft key function assigned to a context key on the Home screen (customisable), see **Set context key shortcut** below.

Set context key shortcut

The shortcuts available for selection as shortcuts are set during the customisation of your radio.



NOTE: You can only use the left and right context keys and soft keys on the top level screen (Home Screen).











To set a context key Home Screen shortcut

















1. Open the Home screen.
2. Press and hold the context key until the **Context Key Selection** box appears.
3. Navigate to the shortcut in the list and press **Select**.









The key is reconfigured and the new shortcut label appears in the Home screen.





Status icons

Icons appear on the status line (at the top of the display) when the radio is engaged in certain activities or when certain functions are active.

Icon	Description
Security and Emergency	
	<p>Emergency Appears when emergency operation mode is active on your radio and an Alarm call is in progress.</p>
	<p>Air Interface Encryption disabled Calls and Callouts will not be encrypted.</p>
	<p>E2E Encryption enabled The Secure Communications icon indicates that the selected talkgroup is customised for End-to-End Encryption. In other words, calls you make by pressing the PTT button are End-to-End Encrypted.</p>
	<p>E2E Encryption disabled Indicates that the call is not encrypted.</p>
	<p>Key agreement Indicates that a cryptographic key agreement is in progress between the radio and the Key Management Centre (KMC) on the network. (See End-to-End Encryption on page 111.).</p>
Trunked Mode Operation (TMO)	
	<p>Outgoing TMO call in progress You are in a call that you initiated.</p>
	<p>Incoming TMO call in progress You are in a call that was initiated by another person or your dispatcher on the TMO network.</p>
	<p>Missed incoming TMO call You have missed an incoming TMO call. The blue LED flashes.</p>
	<p>Scanning enabled Your radio is scanning (listening) to all available talkgroups within your scan list for activity.</p>
	<p>Broadcast Call A high-priority group call (point-to-multi-point) initiated by your Dispatcher to all network radio users. You cannot reply to the caller.</p>
Direct Mode Operation (DMO)	

Icon	Description
	Incoming DMO call You are in a DMO call that was initiated by another radio user.
	Outgoing DMO call in progress You are in a call to another radio user.
	Missed incoming DMO Call The blue LED flashes to notify you that you have missed an incoming DMO call.
	DMO Gateway detected Appears when the radio has detected a DMO gateway. The icon disappears when the radio moves out of range of the gateway.
	DMO Gateway off
	DMO Repeater detected Appears when a DMO repeater is detected and the radio can communicate with any other radios in the selected DMO talkgroup which are also in range of the repeater.
	Repeater ignored
	Repeater mode off
	DMO transmission power. The radio has been set to a higher transmission power than the normal transmission power level.
	DMO transmission power. The radio has been set to a lower transmission power than the normal transmission power level.
General icons	
	Migrated Your radio is registered on a Visited Network.
	Good radio coverage Indicates good radio coverage.
	No service Indicates poor signal or no radio coverage.
	Low battery warning Appears when there is less than 12% charge remaining in the battery.
	Keypad locked
	Transmit Inhibit Indicates that you have activated transmit inhibit and the radio is unable to transmit (overridden when Emergency mode is activated).

Icon	Description
	<p>New message in Inbox The blue LED flashes to notify you that there is an unread message in your Inbox.</p>
	<p>Privacy mode active during a call Appears for the duration of a call when Privacy mode has been activated to prevent any other calls interrupting an important individual call.</p>
	<p>Pre-emptive Call If pre-emptive priority calls have been customised on the radio. The icon is displayed if you or another user has initiated a pre-emptive call on the network.</p>
	<p>Covert operation mode enabled The radio turns off any visual and sound alerts, and displays this icon when covert operation mode is enabled.</p>
	<p>Group Focus Appears when Group Focus is enabled, preventing any calls from other talkgroups (other than the selected talkgroup) connecting to the radio.</p>
	<p>User Profile Appears when a user profile is activated. Your radio may be programmed for a number of user profiles. The number next to the icon indicates the chosen user profile.</p>
	<p>Communication Type Mismatch This icon appears when there is a mismatch in communications and is activated when:</p> <ul style="list-style-type: none"> • the radio is out of range of a gateway when another radio within range of the gateway is in a group call, and you cannot participate in the call. and that you cannot take part in the call. • a radio out of range of the gateway is attempting to respond to a group call, and the speech is not being routed using the gateway to TMO users. • a radio within range of a DMO Repeater cannot make a call and attempts to set up a call in DMO instead, the icon appears on all radios within the talkgroup to indicate that there are members of the talkgroup who cannot take part in the call.
	<p>Lone Worker protection enabled Indicates that you have enabled the Lone Worker feature on your radio.</p>

Icon	Description
	Man Down motions and tilt sensors active You have enabled the Man Down feature and the motion and tilt sensors are active.
	Man Down Tilt sensor active You have enable the Man Down feature, but only the tilt sensor is activated.
	Man Down motion sensor active You have enable the Man Down feature, but only the motion sensor is activated.
	GPS tracking enabled Indicates that the GNSS (Global Navigation Satellite System) function has been enabled.
	GPS tracking not available

LED indicators

Blue LED

The blue LED indicates either a missed event, such as a missed call or unread message, or your Bluetooth® status (if enabled). Press the Missed Event key to view missed events.

LED Indication	Description
Flashing on for 1 second, off for one second, on for another second, then off for seven seconds	Missed event
One flash every 10s	Bluetooth® function is enabled
Continuous rapid flashing	Radio is in Bluetooth® discoverable (visible) mode

Tri-colour LED

The tri-colour LED indicates the operational state of the radio.

LED Colour	Description
Solid green	Radio is powering on or in a call and receiving
Solid red	Radio is in a call and transmitting
Intermittent flashing red	Attempting to connect to the network or incoming telephone SDS/Status message or battery low warning
Flashing orange	Incoming telephone call or SDS/Status message

LED Colour	Description
Intermittent four flashes orange	Transmit Inhibit mode or Fallback mode are active

Emergency button

The orange button on your radio is typically programmed to activate an Alarm Call. See **Emergency operation** on page 26.

Press and hold (2 seconds) the Emergency button to initiate an Alarm Call.

Getting Started

Antenna

Only use approved intrinsically safe antennas with this product. The use of non-approved antenna will result in non-compliance with regulatory requirements and product safety ratings.

Your radio must be fitted with an antenna at all times (unless your radio is used with an external antenna such as an RSM) during operational periods. Transmitting without an antenna attached may damage the product. Your radio is designed for use with Sepura approved antennas.

Always ensure that the seal between the antenna and the radio is maintained.

Never touch the antenna when the radio is transmitting. Ensure your radio is powered off before fitting or removing the antenna.

Fitting the antenna

1. Insert the base of the antenna into your radio's antenna connector.

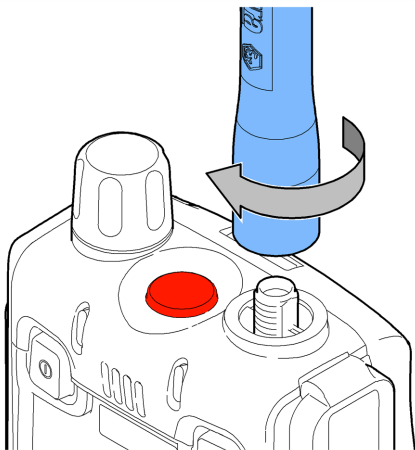

2. Rotate the antenna clockwise until it is finger tight. Then apply another 1/4 turn clockwise.

Removing the antenna

Rotate the antenna counter-clockwise until it can be removed from the radio.

Fitting a microSD card

Your radio supports 4 GB cards that must be formatted for the FAT16 file system.

1. Use a PH00 small screwdriver to remove the screw as shown and lift the cover.

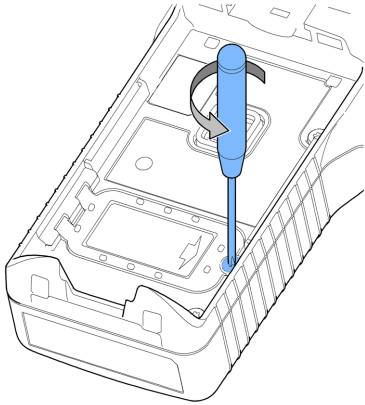

2. Insert the card into the slot on the underside of the cover as shown, ensuring that the card is secured between the two tabs.

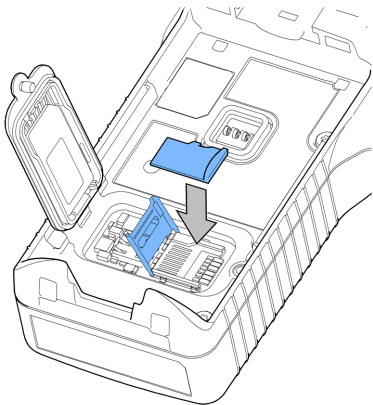

NOTE: Use care when opening/closing the metal card retainer. If it becomes detached, it can be clipped back into place.

3. Carefully close the metal retainer.

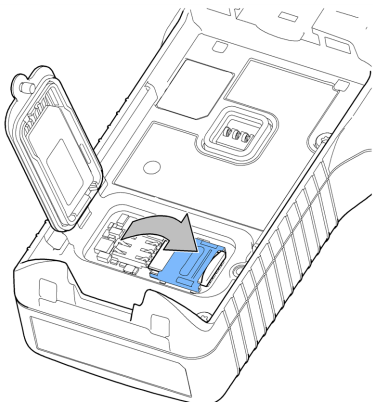

4. Close the cover and secure using the screwdriver. Tighten to 0.1 Nm (pinch tight) to ensure a seal is maintained. Do not over tighten. You must ensure that the compartment cover is secured. Not securing the cover will affect your radio's IP rating.

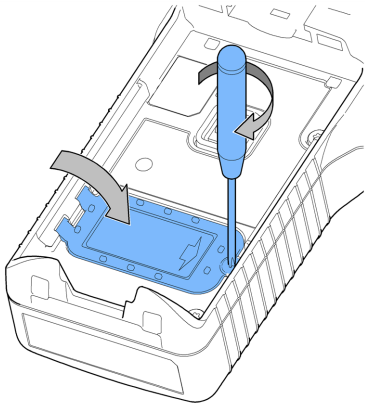

Fitting a Smartcard

If required by your network operator, you may need to fit a Smartcard to your radio.

1. Use a PH00 small screwdriver to remove the screw as shown and lift the cover.

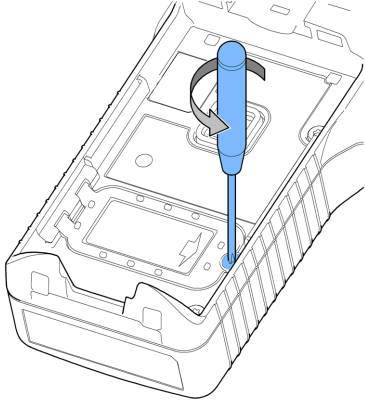

2. Insert the card into the slot on the underside of the cover as shown, ensuring that the card is secured between the two tabs.

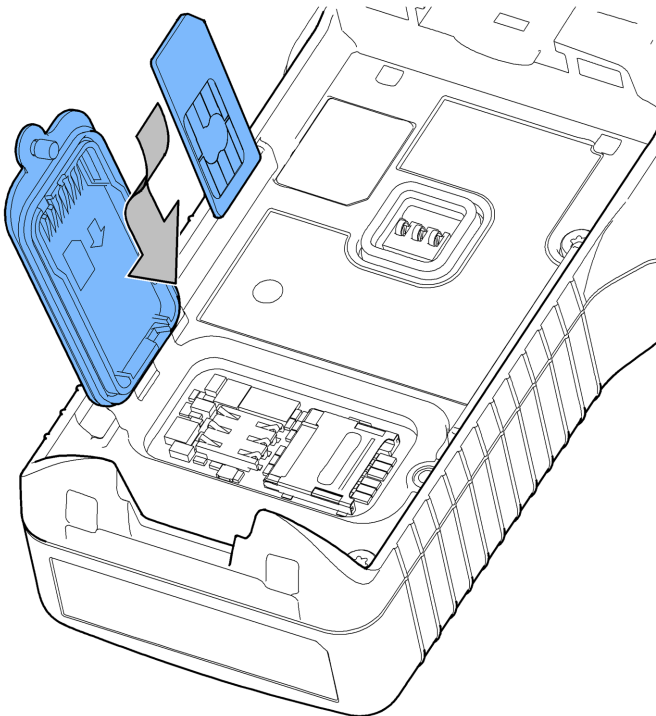

3. Close the cover. Tighten the screw to 0.1 Nm (pinch tight) to ensure a seal is maintained. Do not over tighten. You must ensure that the compartment cover is secured. Not securing the cover will affect your radio's IP rating.

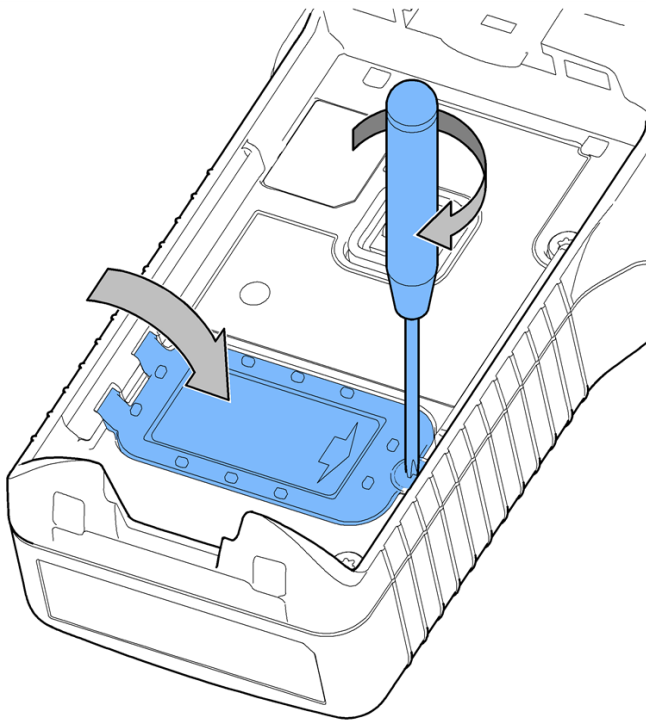

Caution! Risk of damage to the radio. Do not attempt to remove the card holder cover by levering along the sealed edges with tooling. The cover must be refitted correctly to retain the radio's IP rating.

Caution! Risk of damage to the radio. Do not over-extend the card holder in the open position as this can cause permanent damage.

Power on

To power on, press and hold (2 seconds) the Mode key.

Your radio attaches to the last selected talkgroup when it is powered off (if it is 'in service'). This is customisable.

Depending on your radio's customisation any of the following may display:

- the percentage of charge remaining, if a Sepura battery is fitted
- a company logo
- a splash screen
- a welcome screen
- a PIN entry screen



NOTE: A message may be displayed relating to the authenticity of your battery or attached accessory. A message may appear if your software licence has or is about to expire.

If your radio supports **Radio User Assignment (RUA)**, which authenticates your radio on the network, you may be prompted to log on to your network. See **Authentication** on page 74.

If an accessory is detected when the radio is powered on, and it is the same accessory that was attached at power off, the radio will continue to operate using the selected accessory profile. See **Accessory profiles** on page 116.

Power off

Caution! Risk of damage to the radio. Do not power off the radio by removing the battery. The radio must be powered off correctly to ensure that it performs a controlled 'powered down'.

To power off, from the Home screen press and hold (4 seconds) the **Mode** key. A message may display whilst your radio disconnects from the network.

- Scroll to the **Shutdown** option, then press the **Select** key to power off your radio. Before powering down, alerts and messages may be sent.

If your radio is configured to provide an option to delete Callouts, navigate to **Shutdown** or **Delete Callouts** then press the **Select** key.

Locking and unlocking the keypad

To prevent accidental activity during operation, you can lock the keypad. This will also prevent access to the radio's functions if the radio is stolen. When the keypad is locked, the  Key icon appears in the status line.

The keypad can be locked manually or set to lock automatically after a period of inactivity.



NOTE: If customised, your radio's keypad can be locked when an accessory is attached.

Receiving calls with locked keypad

If you receive a telephone call when the keypad is locked your radio can be customised so that the **Select/Send** key can still be pressed to answer it. If the call is accepted the whole keypad is unlocked. Your radio can also be customised so that you can press the **Cancel/Home** key to reject the call and in this case the keypad remains locked.

Navi-knob with locked keypad

Your radio may be customised so that the Navi-knob is locked when the keypad is locked. In this case you cannot alter the volume by rotating the Navi-knob.

Your radio can also be customised so that the Navi-knob remains unlocked and in this case it can be used *for volume control only* while the keypad is locked.

Side button soft key with locked keypad

Your radio may be customised so that the side button soft key is locked when the keypad is locked. In this case you cannot activate any programmed features by pressing the button.

Your radio can also be customised so that the side button soft key remains unlocked and in this case it can be used to activate any programmed features while the keypad is locked.

To lock/unlock the keypad:

Press the * (star) key (or a designated soft key), then press the **OK** context key to lock/unlock the keypad.

To quickly lock and unlock the keypad, press and hold (2 seconds) the * (star) key.

If you press any other key while the keypad is locked no action is taken. The Navi-knob remains unlocked when the keypad lock is enabled. A message is displayed to remind you that the keypad is locked.

Alternatively, you can:

1. Select **Menu > Options > Settings > Keypad Lock**.
2. Press **Lock** to lock the keypad.

Setting the radio to automatically lock the keypad

You can set the radio to automatically lock the keypad after a period of inactivity.

1. Select **Menu > Options > Settings > Timed Keypad Lock**.
2. Press **Toggle** to enable/disable auto keypad lock.

Home screen

The top level screen, known as the **home screen**, appears when the radio powers on and when it is idle.

To quickly get back to the home Screen, press and hold (2 seconds) the Cancel/Home key.

The **status line**, at the top of the screen, displays various icons to indicate the state of operation or when certain functions such as keypad lock have been activated. It can also be configured to display the Network Name when the radio is idle.

The **context key labels** at the bottom of the screen indicate what the context key directly below the label is configured to do. These labels change according to where you are in the menu hierarchy.

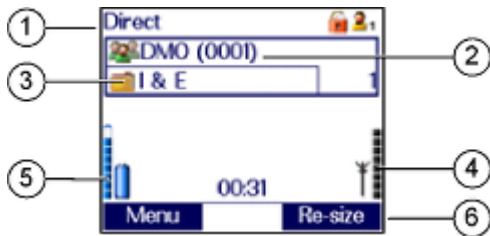

#	Description
1	Status line
2	Talkgroup
3	Folder
4	Coverage indicator
5	Battery charge indicator
6	Context key options

Shortcut Bar

You can easily access commonly used radio features such as your Inbox, and turn features on and off using the **Shortcut Bar**. The Shortcut Bar can contain up to 5 radio features and some of these can be paired with notifications to alert you to a missed call or a new message in your Inbox.

To open the Shortcut Bar, in the Home screen press the Shortcut context key or the Up navigation key.



#	Description
1	Use the navigation keys to scroll through the notifications and features. Notifications always appear to the left of features. Press the Right navigation key to continue scrolling right to view more shortcuts (if available).
2	To open a notification or feature, highlight it and press the Select context key.
3	Press the Back context key to close the Shortcut Bar without opening a feature. The Shortcut Bar cannot be closed if there are notifications.



Notifications

Like a Smartphone, your radio can display notifications to indicate a missed call or new message. They also appear when certain functions are enabled such as mute and transmit inhibit. Your radio can display up to 5 notifications, and up to 5 shortcuts for commonly used radio features.

Some features can be paired with notifications, such as your Inbox so when a message is received a notification appears in the Shortcut Bar to alert you to the unread message. When paired with a

feature, the feature icon appears with a notification badge . Notifications paired with features appear to the left of all other feature icons.

The following notifications can be paired with a feature:

Icon	Notification	Paired Feature
	Unread message	Inbox
	Missed call	Call History
	Missed Callout	Callout

To close a notification:

From the Home screen, press the **Shortcut** context key or the Up navigation key to open the Shortcut Bar, highlight the notification then press the **Select** context key. Use the feature in the usual way, for example, read an unread message or respond to a missed call. The notification automatically closes and disappears from the Shortcut Bar.



Menu







Your radio is customised by your service provider or organisation with a number of features that are accessed from the main menu.

- To open the menu, in the Home screen press Menu or press the Down navigation key.
- To open a sub-menu or menu option, scroll to the option (highlight it) and press Select.
- To return to a higher level menu, press Back.
- To return to the Home screen at any time within the menu hierarchy, press and hold (2 seconds) the Cancel/Home key.

Menu options

The following icons are used to identify the sub-menus that provide access to further options.

Icon	Menu option
	Phone Add, edit and delete your personal contacts within your personal folder. Search (or filter) your contacts to locate the contact you want and initiate a call. Review your call history.
	Messages Read, create, save and send text (SDS) messages. View picture messages (if customised). Select and send a status message. Clear your mailbox of unwanted messages.

Icon	Menu option
	Groups Search your talkgroup folders and select a talkgroup. Enable scanning of your selected talkgroups. Set up your speech call settings.
	GPS Manage your GPS location and position settings. View your current location, direction and speed.
	Applications Your radio may be customised with a number of applications such as Man-down and Lone Worker. Your service provider or organisation may have installed specific applications (Short Data Applications) to help you in your role. Access WAP sites.
	Networks Manage your network connections and DMO options. Change your operating mode (TMO/DMO/Repeater). Enable/disable Transmit Inhibit mode when working in RF sensitive areas.
	Options Personalise your radio settings such as backlight, text size and language. Reset your radio to the last customisation, with options to keep personal data settings such as contacts in the phonebook.
	User Profiles Select customised profiles designed specifically for the way you work.
	Help View help, such as a list of customised soft keys on your radio.

SmartMenus

SmartMenus are designed to provide quick access to regularly used radio features, usually with a common theme. Your service provider or organisation may customise your radio with a number of SmartMenus, for example you may have a SmartMenu containing all your Quick Status messages, another for user profiles and another for selecting operational modes such as toggling on/off covert mode, Transmit Inhibit, loudspeaker mute and so on.

SmartMenus are assigned to a soft key. To open a SmartMenu, press a soft key or press and hold (1 second) a key on the keypad.

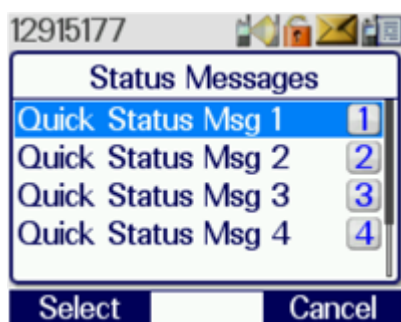

Use the navigation keys to scroll the list of options on the SmartMenu. Options are labelled with a number, shown to the right of the option. To select the option, press the key that corresponds to the number of the option, for example to select option 3, press the 3 key. Note that using this method only options numbered 1 to 12 can be selected using the keys on the keypad (press 0 for option 10, the Star (*) key for option 11 and the Hash (#) key for option 12). For options numbered 13 onwards, scroll to the option (highlight it), and press Select.

Help

The Help menu displays a free text area which is usually customised to indicate radio soft key assignments. It may also be used to record any required help text.

To access help

Use one of the following:

- Press a dedicated soft key (default is normally key '0' zero).
- Press **Menu > Help**.

Emergency operation

Emergency operation is available in TMO if the radio is in service. If your radio is operating in DMO when you make the emergency call, the radio switches to TMO before making the emergency call. If the radio cannot make the call in TMO, the radio automatically switches back to DMO to make the call.

The orange button on the top of your radio can be programmed to initiate an Alarm call at any time when your radio is in operation. This button is known as the **Emergency button**.

Your radio may be customised to perform one or more of the following:

- Initiate an Alarm call set up to one or more pre-defined users (typically to your dispatcher and other members of your talkgroup) and/or;
- Send an Emergency Status message to an individual, the dispatcher or a talkgroup and/or;
- Send a position report (GPS dependent).

If you are working in RF sensitive areas and have enabled Transmit Inhibit, prohibiting radio transmission, initiating an Alarm call will override the Transmit Inhibit feature and the Alarm call will be transmitted.

Your service provider or organisation can provide information on how your radio is customised for Alarm calls and how to operate your radio in emergency situations. If you are working in a sensitive environment your radio may be customised for Silent Alarm calls where audible and display alerts are disabled, or your radio may be customised for Live Microphone that allows you to call for assistance hands-free without pressing the PTT button.

Silent Alarm Call

If you are working in sensitive environments where the audible and display alerts associated with an Alarm call are inappropriate, your radio can be customised to make a Silent Alarm call (without acoustic or screen alerts). Silent Alarm calls cannot be activated when operating in Lone Worker or Man Down modes.

When a Silent Alarm call is made, the radio displays the Home screen with the talkgroup associated with call. During the call you may navigate away from the Home screen.

Live Microphone feature

Your radio may be customised with the Live Microphone feature. This feature allows you to broadcast a call for assistance hands-free for a specified period of time and without having to press the PTT button. The radio automatically cycles between transmit and receive communication during a programmed period of time (seconds). Live Microphone is cancelled when the time expires or by pressing the PTT button.

Making an Alarm call

You can still make an Alarm call if the keypad is locked.

To make an Alarm call

1. Press and hold (2 seconds) the Emergency button; a confirmation beep sounds.
2. Release the button and speak into the microphone.

During an Alarm call:

- the microphone is 'live' for a programmed period (seconds) allowing you to speak hands-free without pressing the PTT button (customisable)
- the LED illuminates solid red
- your radio sounds audible tones
- a large emergency symbol appears on the screen
- your identity and talkgroup appears on the display of those receiving the Alarm call

Receiving an Alarm call

An Alarm call overrides any existing calls on the talkgroup.

You know you are receiving an Alarm call when:

- your radio sounds an audible tone
- the LED flashes red
- the emergency symbol appears on the screen
- your radio status changes to **Emergency**

Clearing an Alarm call

You can only clear an Alarm call that you have initiated.

To cancel the Alarm call, press the **Clear** context key.

To cancel the Alarm call, press the **Call Clear** key, the **Clear** context key or the **Cancel/Home** key. Alternatively, your radio may be customised to use the Emergency button to cancel the Alarm call.

Depending on which network is being used, if the TETRA Alarm call is a group call, then—although both of the TETRA Alarm call exit functions will clear the TETRA Alarm call on the call originator's radio—it will not remove the alarm from the system. Radios alerted to the emergency may, depending upon the infrastructure configuration, remain in the TETRA Alarm call condition until the dispatcher clears the call from the system.

When the Alarm call is cancelled, your radio returns to the talkgroup that was selected before the call was initiated.

Sound

Your radio is equipped with a loudspeaker for use during PTT calls and an earpiece for use during telephone calls. You can adjust the volume of the speaker and increase the sensitivity of the microphone (see **Whisper mode** on the facing page) so that you can speak more quietly. Your radio also uses sound to alert you to the various operational states.

Adjusting the volume

Rotate the Navi-knob to adjust the volume. A vertical volume meter displays to indicate the current volume level. The radio sounds an audible tone at the new volume level.



NOTE: Depending on customisation, the volume adjustment audible tone may be disabled.

Adjusting the volume of an audio accessory is achieved using Accessory Profiles. See **Accessory profiles** on page 116.

When the radio is started, the volume will be set at the last adjusted level, unless the radio has been customised to switch on at a predefined level.

Loudspeaker on/off

A soft key may be customised to toggle the speaker on and off.

Alternatively:

1. Select **Menu > Options > Settings > Loudspeaker ON/OFF**.
2. Press **Toggle** or press the **Select/Send** key.

Muting all audio

A soft key may be customised to simultaneously mute the audio output of the radio loudspeaker and any connected accessories and earpieces. Pressing the same soft key again toggles the audio back on at the previously adjusted volume level.

Loudspeaker high/low audio mode

A soft key may be customised to toggle the audio output between the radio's speaker (high audio mode) and earpiece (low audio mode) as required.

An icon is displayed on the status line to indicate the current mode:

Icon	Notification
H	High audio mode
L	Low audio mode

When the radio is in the loudspeaker high/low audio mode:

- If an RSM is connected, audio is routed to the RSM speaker in high audio mode and to the radio's earpiece in low audio mode.
- If an earpiece accessory is connected, audio is routed to the accessory in both modes.
- When the radio is inserted in a car kit cradle, audio is routed to the car kit speaker in high audio mode and to the handset earpiece in low audio mode.
- During incoming or outgoing emergency calls, audio is always routed to the radio's speaker.
- A full duplex call is always routed to the radio's earpiece.

Whisper mode

Whisper mode allows you to talk more quietly than normal but still be heard and understood by the person you are calling. It can be useful to switch to Whisper mode when providing confidential information.

If you select a User Profile which already increases the sensitivity of the microphone, depending on your radio's customisation Whisper mode may not increase the sensitivity further.

To enable Whisper mode

Depending on customisation, to enable Whisper mode, you can:

- press a programmed soft key
- rotate the Navi-knob to decrease the volume to below its lowest level

The radio sounds a low-high level alert when Whisper mode is enabled.

To disable Whisper mode:

Depending on customisation, to disable Whisper mode, you can:

- press a programmed soft key
- increase the volume until the volume level meter displays at least the minimum level
- increase the volume to its loudest level then attempt to increase the volume further

The radio sounds a low-high level alert when Whisper mode is disabled.

Audible tone alerts

Certain events on your radio initiate audible tone alerts. These alerts are attenuated when you select a user profile which uses covert mode (see **User profiles** on page 93).

1. To toggle audible alerts
2. Select **Menu > Options > Alerts > Audio Alerts**.
3. Press **Toggle** (or the **Select/Send** key) to toggle alerts on/off.

If your radio is powered off with Audio Alerts disabled, they remain disabled when the radio is next powered on.

Personalising your radio

You can personalise your display settings (such as text size, backlight, inverting the screen and change languages) and create a personal phone book containing your own contacts.

Invert the display

When you are wearing the radio on your shoulder, attached to a belt or to a body vest, you may want to flip the display upside down to make it easier to read. The Invert Display option rotates all screen elements by 180 degrees.

This feature is commonly assigned to a soft key or SmartMenu.

To invert the display:

1. Select **Menu > Options > Settings > Display Settings > Invert Display**.
2. Press the **Toggle** context key. When a tick appears in the check box, the display is flipped, and when the check box is empty the display is set to normal.

When the display is inverted, the navigation keys work in opposite to their normal function. Press the Up key to scroll **down** and the Down key to scroll **up**. The Right key to scroll **left** and the Left key to scroll **right**.

Adjusting the backlight

When a call or message is received, and when you press any key, the backlight lights up the display and keypad. The length of time the backlight illuminates is set during customisation.

To adjust the backlight:

You can toggle the backlight on/off by using a soft key or from a **SmartMenus** on page 24 (if customised).

Alternatively:

1. Select **Menu > Options > Settings > Display Settings > Backlight**.
2. Press the **Toggle** context key.

To adjust brightness:

1. Select **Menu > Options > Settings > Display Settings > Backlight**.
2. Rotate the **Navi-knob** to adjust the intensity of the backlight and the keypad illumination on a scale of 1–7 (max.).

Adjusting text and icon size

Your radio uses the default size for the text and icons set during customisation, however it also supports a number of different size modes that control how text and icons are displayed, which can make them easier to see from a distance.



NOTE: When selecting larger modes, some prompts or icons may not appear on the radio display.

Your radio supports the following modes:

Normal Mode allows the maximum amount of information available to be displayed in a compact character size.

Large Mode displays screen information in a large character size.

Very Large Mode displays the talkgroup number or talkgroup name, as customised, in an extra large size on the Home screen with all other screens in Large mode.

To change text mode:

1. Select **Menu > Options > Settings > Display Settings > Text Size**.
2. Use the **Up and Down** Navigation keys to highlight the mode and then press the **Select** context key.

The radio displays the Home screen, with the text and icons appearing in the chosen mode.

Default text mode

Your radio may be customised with a pre-configured default text mode set. When the radio is powered on or restarted, the display reverts to the default text mode size.



NOTE: If the radio has been configured to change to large mode when fitted to a car kit, the display will not revert to the default text mode.

Setting the display language

Your radio operates in the language chosen during customisation and can support two display languages. The display uses the default language if the radio is only customised for a single language, or the currently selected language if two languages are programmed.

Your radio may be customised with a soft key or provide an option on a SmartMenu to change the display language. See **SmartMenus** on page 24.

To change the language:

1. Select **Menu > Options > Settings > Language**.
2. Scroll to the language option, and then press the **Select** context key.

The Home screen appears and the display shows the selected language.

Menu style

You can display the menu in **Grid**, **List** or **Compatibility** style.

1. Select **Menu > Options > Settings > Display Settings > Menu Style**.
2. Select one option:
 - **Grid**—set **Grid** menu style
 - **List**—set **List** menu style
 - **Card**—set **Card** (Compatibility) menu style

Grid style

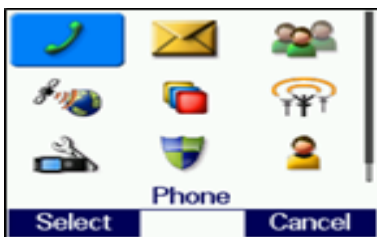

- highlight items using the four navigation keys
- to open an item press **Select**
- to return to the top level screen press **Cancel** or **Cancel/Home** key.

List style



- highlight items using the **Down** and **Up** navigation keys.
- to open an item press **Select**
- to return to the top level screen press **Cancel** or the **Cancel/Home** key.

Compatibility style (card)

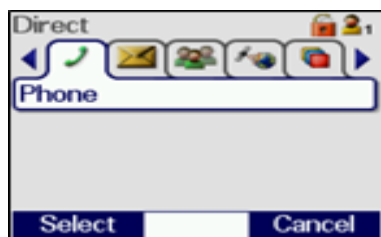

- highlight items using the Left and Right navigation keys
- to open an item press **Select**
- to return to the top level screen press **Cancel** or **Cancel/Home** key.

Time and Date

Your radio can be customised to display the current time and date on the Home screen. The time is shown in 24 hour format and the date is shown in digital format (dd/mm/yyyy).

To view and edit the time and date

1. Select **Menu > Options > Settings > Time and Date**.
2. Press **Edit** or press the **Select/Send** key.
3. Enter the digits required (see **Text entry** on page 64).
4. Press **OK** or the **Select/Send** key to save your changes; press **Cancel** or the **Cancel/Home** key to abandon your changes.

Talkgroups and folders

Talkgroups are pre-programmed onto your radio. Each talkgroup typically contains users who have a similar role or who are within a distinct location or who provide a service that you would use. They are organised into folders to help you quickly select one that is applicable to your environment or situation.

A folder can contain both DMO and TMO talkgroups, but only those talkgroups applicable to the current operating mode, either DMO or TMO, appear when a folder is opened. In TMO, only those talkgroups available on the current network are displayed. The folders available depend on the customisation of your radio; various 'special' folders are also programmed into your radio (see **Special folders** below).



NOTE: If you want to change from a DMO talkgroup to a TMO one, you need to change the operating mode first (see **Operating Modes** on page 77).

A top level folder can have a number of sub-folders, similar to a folder structure on a computer, and a folder can contain both folders and talkgroups. If a folder contains sub-folders and talkgroups, two tabs appear—one for sub-folders and the other for  talkgroups. You can use the Left or Right navigation keys to switch between the tabs.

Your radio may be customised for [Talkgroup Selection Mode](#) or [Folder Selection Mode](#). How you select a talkgroup depends on which mode your radio is customised to use. When you select a talkgroup, the radio attaches to that talkgroup. Your radio can only participate in calls with talkgroups it is attached to via the network. When ongoing calls are detected on any talkgroup your radio is scanning you can join in by pressing the PTT.

When the radio is attached to a talkgroup, the talkgroup and folder appear on the Home screen (see **Home screen** on page 21). If a talkgroup and folder are not shown:

- the radio may not have attached to the last used talkgroup at power on, or
- it was attached to a DGNA talkgroup which has been deassigned, or
- it may be attached to hidden background talkgroups, or
- a folder has not been selected (Folder Selection Mode only), or
- a change of network may have occurred and the last used talkgroup may not be usable on the current network.

When your radio is powered on, if possible it re-selects either the default talkgroup or connects to your last selected talkgroup.

Special folders

In addition to the 'standard' folders created to contain your talkgroups, your radio can be customised with Special folders. Special folders can only contain talkgroups (they cannot contain folders). Some Special folders are continuously scanned, and when ongoing calls are detected you can join in by pressing the PTT.

The following special folders may be programmed into your radio during customisation:

- Favourites—frequently used talkgroups that can be added to the folder during customisation or added by the user.
- All—contains every talkgroup programmed into your radio including those in special folders. Only available on radios customised for Talkgroup Selection mode.
- DGNA—contains up to 50 dynamically assigned groups. The contents are automatically maintained by the radio and are not customisable in Talkgroup Selection Mode. You can select a DGNA talkgroup. In Folder Selection Mode, the scan state (scanning enabled or disabled) of a talkgroup can be changed and the folder can be emptied using the **Folder Restore** option.
- UDSL—user-defined scan list(s), see **User Defined Scan Lists** on page 41. A list of talkgroups which you can modify yourself. If you select a UDSL **instead of a specific talkgroup** your radio scans all the talkgroups in that UDSL. Until a UDSL is selected its talkgroups are not scanned for activity. For more information see **User Defined Scan Lists** on page 41. Only available on radios customised for Talkgroup Selection mode.
- Always attached—talkgroups which the radio scans continuously for activity. A talkgroup in this folder can be selected as the requested talkgroup in Talkgroup Selection Mode.
- Background—talkgroups which the radio scans continuously for activity. You cannot select a background talkgroup in this folder as your requested talkgroup.

Talkgroup Selection Mode

When the radio is customised for Talkgroup Selection Mode, the selected talkgroup becomes the requested talkgroup to which you make calls.

You can insert frequently used talkgroups in the **Favourites** folder, making it quicker and easier to change your talkgroup. Additionally your radio may be customised for [Quick Groups](#) that allow you to change to a frequently used talkgroup using a soft key.

You can create your own **user defined scan lists** that are saved into the **UDSL** special folder. The UDSL folder 'greys out' (disables) talkgroups that are invalid for the current network. The scan list allows you to set scanning priorities on the talkgroups, so the radio can prioritise calls between the scanned talkgroups. See **User Defined Scan Lists** on page 41.

Typical folder arrangement

The following illustration shows how the folders can be used to organise talkgroups:

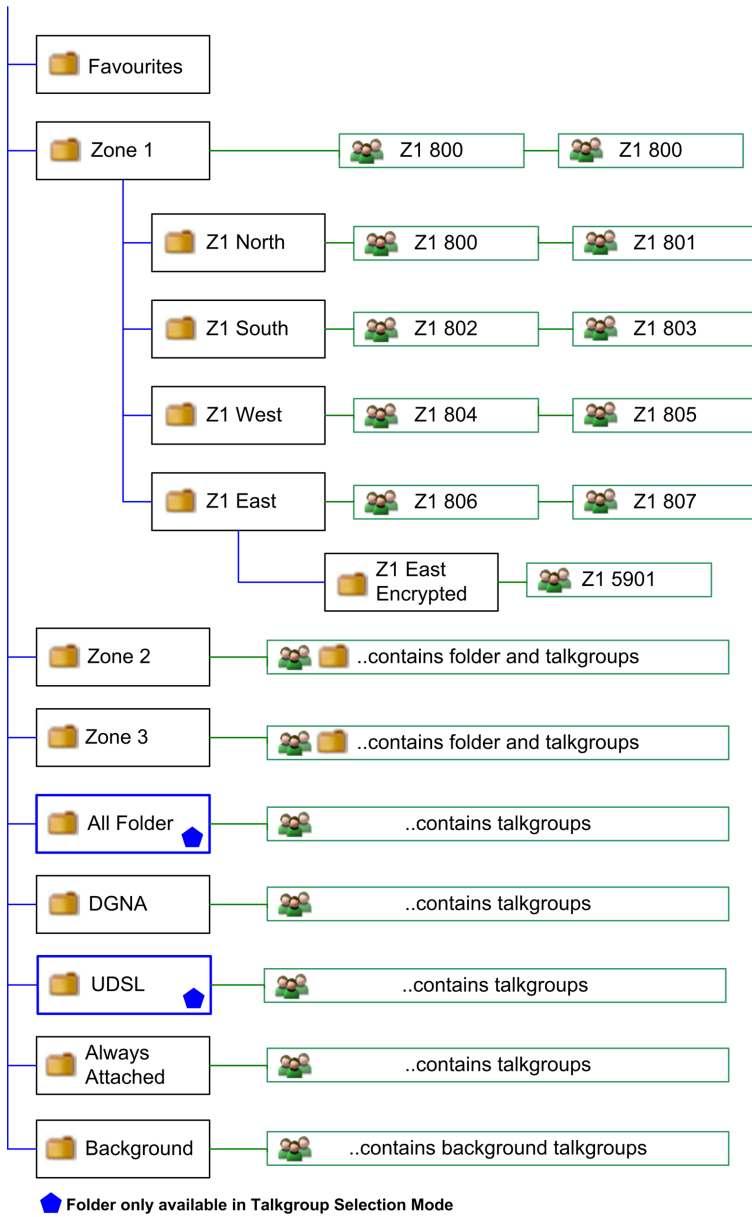

Selecting a talkgroup

You can use one of the following methods to select a talkgroup:

- Press the **Mode** key (once) to activate the talkgroup selection box.
- Press a customised context key from the Home screen to activate the talkgroup selection box.
- From the **Menu** navigate to the **Groups** menu.
- Use a soft key to return to your Quick Group.



NOTE: Talkgroups in the **Smart Call Folder-1** or **Smart Call Folder-2** folders can only be accessed when the appropriate Smart Call mode has been selected from the Speech Call Settings screen or by using a soft key. (See **Smart Calls** on page 60.)

1. Press the **Mode** key (once). The current selected folder and talkgroup appear in a talkgroup selection box.



To quickly change to another talkgroup within the same folder, enter the number of the talkgroup. If the talkgroup is not in the same folder, select the All Folder and enter the number of the talkgroup.

2. Use the navigation keys to scroll through the folders. The arrows in the folder name and level areas show which navigation keys you can use. Use the **Left and Right** navigation keys to move between folders at the same level, and the **Up and Down** navigation keys to move between the folder levels (sub-folders).



3. Rotate the **Navi-knob** to select the desired talkgroup within the folder. The directional arrows under the talkgroup name indicate the rotational direction of the Navi-knob.
4. Press the **Select** context key to attach to the talkgroup.

Opening a folder

1. Select **Menu > Groups > Folders**.
2. Highlight a folder, press **Options** then select **Open**.

To navigate back 'up' the folders list, press **Options** then select **Back**.

Searching for folders and talkgroups

You can search for talkgroups or folders by filtering on a text string. Items which do not match the string are temporarily 'filtered out' of the list.

You can use either:

- **Search card**—to filter the current talkgroup/folder folder.
- **Search all**—to filter across all talkgroups and folders

1. To search inside a specific folder, open that folder.
2. Press **Options** then select **Search card** or **Search all**.
3. Enter characters you wish to filter against (see **Text entry** on page 64).

The list of matching names is dynamically filtered as characters are entered. Only matching

talkgroups or folders remain in the list.

4. To cancel the filter operation select the **Stop search** option.

Inserting a talkgroup into a folder

If a folder is editable you can use the **Insert** option to insert a talkgroup into it.

Deleting a talkgroup from a folder

If a folder is editable you can use the **Delete** option to remove a talkgroup from it. The talkgroup can still be selected from the All folder if customised, or by entering the talkgroup number directly in the Talkgroup Selection box.

Create a 'favourite' talkgroup folder

To quickly access frequently used talkgroups, you can add them to the **Favourites** folder.

1. Select **Menu > Groups > Folders > Favourites**.
2. Press **Options**, then select **Open**.
3. Navigate to the **New Group** option then press **Options**.
4. Press **Insert**.
5. Select the talkgroup you want to add (from any folder).
6. Press **Select** to insert the talkgroup into the Favourites folder.

If the **New Group** option is not available, you do not have 'edit' permissions on the Favourites folder. The Favourites folder must be set to 'Edit' at customisation.

Quick Groups

You can quickly change to a different talkgroup by pressing a customised **Quick Group** soft key specified for that talkgroup.

To select the Quick Group talkgroup

Press the customised **Quick Group** soft key. Alternatively, view the Quick Group using the menu then press **Select**.

To view your Quick Groups

You can view the talkgroups and folders associated with your assigned Quick Groups.

1. Select **Menu > Groups > Quick Groups**.
2. Use the **Up and Down** navigation keys to highlight a Quick Group then press **Select**.

To change the talkgroup associated with a Quick Group

Your radio can be customised to allow you to change the talkgroup associated with a Quick Group.

These changes may be overwritten when your radio is reprogrammed.

Select and view a Quick Group (described in **To view your Quick Groups** on the previous page) then:

- Select **Options > Change > Current**.

Your current talkgroup is now associated with the selected Quick Group.

User Defined Scan Lists

A User Defined Scan List (UDSL) is a list of talkgroups which are either fixed, or user-definable. Any talkgroups in the UDSL that are invalid for the current network are disabled and are shown 'greyed out' in the talkgroup list.

Until a UDSL is selected the talkgroups it contains are not scanned and your radio cannot receive calls from them. Your radio can have a maximum of 20 UDSLs, and up to 10 talkgroups can reside within each UDSL.

If you select a UDSL (in the same way as you select a talkgroup):

- the talkgroups it contains are scanned, allowing your radio to receive calls from any of the talkgroups in the UDSL
- the  UDSL icon is displayed in the right hand corner of the radio display
- calls are made to the talkgroup designated as the 'selected talkgroup'. If there is no selected talkgroup in the UDSL, calls are made to the talkgroup with the highest priority.

Each talkgroup in a UDSL can have up to three different levels of user-definable group **scan priorities** which are used by your radio when deciding which call to follow when a call on one talkgroup is active and a call on another talkgroup is received. The scan priority of each talkgroup in a UDSL is shown at the right hand side of the screen as ▲ (High), ► (Normal) or ▼ (Low). You can designate a selected talkgroup in each UDSL. You can add and remove talkgroups from a UDSL.

View and edit scan list

1. Select **Menu > Groups > Scan Lists**.
2. Use the **Up and Down** navigation keys to select one of the UDSLs and press **Open**.
3. Press **Edit**.



Change default (selected) talkgroup

1. Use the **Up and Down** navigation keys to select one of the talkgroups in the UDSL.
2. Select **Edit > Options > Select**.
3. Select **Edit > Options > Save**.

Add a talkgroup

1. Press **Options > Add**.
2. The talkgroup selection box is activated. Select a talkgroup as described in **Selecting a talkgroup** on page 38 then press **Select**.
3. Select **Edit > Options > Save**.

Remove a talkgroup

Select the talkgroup you wish to remove then:

1. Select **Edit > Options > Delete**.
2. Select **Edit > Options > Save**.

Changing group scanning priority

1. Select **Edit > Options > Change Priority**.
2. Select scan priority **▲** (High), **▶** (Normal) or **▼** (Low) then press **Select**.
3. Select **Edit > Options > Save**.

Scanning ON/OFF

Scanning of talkgroups can be enabled and disabled. If scanning is disabled, the radio will ignore incoming calls on these talkgroups. Your current talkgroup is always scanned.

Background talkgroups are always scanned and will continue to be scanned when scanning is disabled.

1. Select **Menu > Groups > Scanning ON/OFF**.
2. Press **Toggle** (or the **Select/Send** key) to enable/disable scanning.

Folder Selection Mode

If your radio is customised for **Folder Selection Mode**, you will need to select a folder, which is typically configured with zero or one selected TMO talkgroup and/or one selected DMO talkgroup, which the radio uses to make calls.

When a folder is selected and a talkgroup within that folder is selected as the requested talkgroup, they appear on the Home screen. If a folder is not selected when the radio powers on, the message

'**No Folder**' appears on the Home screen. When a folder is selected that does not have a selected talkgroup, the message '**No Selected Group**' appears.

Depending on the customisation of your radio, when you press the Groups key from the Home screen, one of the following is activated:

- **Folder list.** The current selected folder opens. You can change the talkgroup within the selected folder or use the Back key to display the Folder list (a list of selectable and non-selectable programmed into your radio) and choose a new folder. The selected folder within the Folder list and the selected talkgroup within a folder are indicated by the  icon.
- **Talkgroup Selection box.** The selected talkgroup (appears in bold typeface) and the selected folder are displayed within a selection box. Only those talkgroups that are selectable within the selected folder appear in the selection box and you can scroll through the talkgroups using the Navi-knob. An icon appears to the left of a TMO talkgroup, indicating the scanning priority and whether or not the talkgroup is scan-enabled. You can select another folder by scrolling through the folders at the same level as the current folder or those at a higher level or sub-folders within the hierarchy.



NOTE: Only those talkgroups and folders that are selectable appear in the Talkgroup Selection box. Non-selectable folders and talkgroups, such as the Always Attached and the Background folders, do not appear for selection. The exception is the DGNA folder where a talkgroup from the folder can be selected, but the selected folder remains unchanged.

All the TMO talkgroups within the selected folder that are scan-enabled¹ and valid for the current network contribute to the scan list that the radio uses to prioritise calls. If a talkgroup is editable² you can change its scan state (to enable or disable scanning), change its scanning priority (see **Scanning talkgroups** on page 46) and select or deselect it.

A talkgroup can be copied from a folder to another editable folder³, for example you can copy talkgroups from Special folders such as the **Always Attached** folder into a generic folder and copy frequently used talkgroups to the **Favourites** folder, making it quicker and easier to change your talkgroup.

Your radio may be customised for [Quick Folders](#), which allow you to quickly change to a frequently used folder using a soft key.

Opening the current folder

Use one of the following methods to open the current folder:

- Press the **Mode** key (once).
- From the **Menu** select **Groups > Folders** to open the current selected folder.
- Press a customised context key from the Home screen.

To open another folder, press **Back** to navigate back 'up' the folders list. Select the folder you want to open, press **Options** then select the **Open** option and press **Select**.

¹In Radio Manager folder properties, the talkgroup option In Scan List is selected.

²In Radio Manager folder properties, the talkgroup option Editable is selected.

³In Radio Manager folder properties, the Subject Content option is set to Edit.

Selecting a folder

Use one of the following methods to select the current folder:

- From the Home screen, press **Menu** then select **Groups > Folders** to display the current selected folder containing the selected talkgroup.
- From the Home screen, press **Groups**. Depending on the customisation of your radio, either the current selected folder opens displaying all talkgroups within the folder, or the Talkgroup Selection box opens displaying the selected talkgroup and folder.

Additionally, you can select a folder by pressing a soft key to select a Quick Folder or select a folder by entering its Folder ID (see **Selecting a folder using the folder ID** on the facing page) if customised.

You cannot select the **DGNA**, **Always Attached**, **Background** or **Smart Call** folder as your selected folder.

A talkgroup within the folder must be selected before you can make calls. See **Selecting a talkgroup** on the facing page.

To select a folder using the folder list:

1. Press the **Mode** key (once) to open the current folder.
2. Press **Back** to navigate back 'up' the folders list.
3. Scroll to a folder (highlight it) and press **Options**, then scroll to the **Select** option and press **Select**.

Only talkgroups which are valid for the current network are listed in the folder.

To select a folder and talkgroup using the Talkgroup Selection box:

1. From the Home screen, press **Groups**. The current selected folder and talkgroup are displayed in the Talkgroup Selection box. Note that the selected talkgroup appears in bold typeface and an icon indicating the scanning priority and whether or not the talkgroup is scan-enabled (no icon appears for DMO talkgroups).



If you want to change to another talkgroup within the same folder, simply enter the number of the talkgroup.

2. Use the **Left and Right** navigation keys to move between folders at the same level. Use the **Up and Down** navigation keys to move between the folder levels (sub-folders).
3. Rotate the **Navi-knob** to scroll through the talkgroups within the currently selected folder. The directional arrows under the talkgroup name indicate the rotational direction of the **Navi-knob**.



4. Press **Select** to select the folder and attach to the talkgroup.

Selecting a folder using the folder ID

Every folder has a unique identification number (ID) and you can use this ID to quickly select the folder.

Press the assigned soft key to open the Folder ID box. Enter the number of the folder (the name of the folder appears) and press **Select**. The folder is now your selected folder and the selected talkgroup within the folder is your requested talkgroup.

If the folder name does not appear when you entered the folder ID, the folder ID is incorrect.

Selecting a talkgroup

The selected talkgroup within each folder only becomes your requested talkgroup when the folder is selected. Depending on the customisation of your radio, you will use one of the following methods to change the talkgroup.

You can only select a talkgroup that is editable.

To select a talkgroup from the folder:

1. Press the **Mode** key (once) to open the current folder.
2. Scroll to the talkgroup (highlight it) and press **Options**, then scroll to the **Select** option and press **Select**.

To select a talkgroup using the Talkgroup Selection box:

1. From the **Home** screen, press **Groups**. The selected talkgroup and folder appear in the Talkgroup Selection box. The current talkgroup appears in bold typeface.
2. Rotate the **Navi-knob** to scroll through the talkgroups within the currently selected folder. The directional arrows under the talkgroup name indicate the rotational direction of the **Navi-knob**.



3. Press **Select** to attach to the talkgroup. The talkgroup appears in bold typeface. If you have selected a TMO talkgroup, an icon appears to the left of the talkgroup name indicating the scanning priority and whether or not the talkgroup is scan-enabled (no icon appears for DMO talkgroups).

Copy a talkgroup to another folder

Sometimes you may want to copy a talkgroup to another folder, for example you may want to copy your frequently used talkgroups into the **Favourites** folder. You can copy talkgroups from any folder but only place them into a folder that is editable.

You cannot copy a talkgroup from the **Background** or **DGNA** folder, or background/always scanned talkgroups within any folder. If all editable folders contain the maximum number of talkgroups, the **Copy** option is disabled because all of the destination folders are full. A talkgroup cannot be copied into a folder that already contains that talkgroup.

When a talkgroup is copied, it does not retain its properties (scan state, scan priority and selection). For example, if you copied a talkgroup that has scanning enabled, a scanning priority of High and it is the selected talkgroup, when it is copied into the destination folder the scan state is disabled (not scanned), the scanning priority remains the same and it is not the selected talkgroup.



NOTE: You can copy a talkgroup from the **Always Attached** folder for the purpose of making it your selected talkgroup. Any changes to the talkgroup's properties, such as the scanning priority and scan state, will be overridden by the properties set in the **Always Attached** folder.

To copy a talkgroup:

1. Press the **Mode** key (once) to open the current folder. If you want to open another folder, press **Back** to navigate 'up' the folder list, select the folder and press **Open**.
2. Select the talkgroup you want to copy, press **Options** and then select the **Copy** option and then press **Select**.
3. A list of available folders appears. Scroll to the folder you want to insert the talkgroup in to, and press **Select**. A green tick is displayed if the talkgroup has successfully been copied to the folder.

Delete a talkgroup

You can only delete a talkgroup from a folder if the folder is editable.

1. Select the talkgroup (highlight it) and press **Options**.
2. Scroll to the **Delete** option and press **Select**.
3. Press **OK** to delete the talkgroup from the folder.

Scanning talkgroups









The talkgroups that are scanned and the priority scanning order within a folder are set during customisation. If the talkgroup is editable, you can change the scan priority and the scan state (enable or disable scanning).

There are three scan priorities which are used by the radio when deciding which call to follow when in a call and another call is received.



NOTE: You cannot edit the properties (scan state and scan priority) of the talkgroups in the **Always Attached**, **Background** or **Smart Call** folders.

The scan priority appears on the left of the talkgroup as a series of bars (more bars indicate higher priority). If the scan state is enabled the  icon appears in the right-hand corner of the scan priority icon.

Symbol	Priority
	Low priority scanned
	Low priority not scanned
	Medium priority scanned
	Medium priority not scanned
	High priority scanned
	High priority not scanned
	Background talkgroup not scanned
	Background talkgroup scanned

To scan a talkgroup:

1. Press the **Mode** key (once) to open the current folder. If you want to open another folder, press **Back** to navigate 'up' the folder list, select the folder and press **Open**.
2. Select the talkgroup you want to scan and press **Options**, then select the **Scanned** option and press **Select**. The scanning  icon appears in the right-hand corner of the scan priority icon.

To stop scanning a talkgroup, select the talkgroup and press **Options**, scroll to the **Not Scanned** option and press **Select**.

To change the priority of a talkgroup:

1. Press the **Mode** key (once) to open the current folder. If you want to open another folder, press **Back** to navigate 'up' the folder list, select the folder and press **Open**.
2. Select the talkgroup and press **Options**. Scroll to the **Set Priority** option and press **Select**.
3. Scroll to the priority setting (High, Medium or low) and press **Select**. The scan priority icon to the left of the talkgroup changes to the new priority.

Restore folders

The selected folder or all folders can be restored to their original settings. Only editable generic folders, the Favourites and DGNA folders can be restored.

When you restore a folder or all the folders, the following occurs:

- any talkgroups added to a folder will be removed,
- any deleted talkgroups will be restored,
- talkgroup properties (scan state and scan priority) are restored, and
- the selected talkgroup for each mode (TMO and DMO) is reset.

You cannot restore the **Always Attached**, **Background** or **Smart Call** folders.

To restore a folder:

1. Select the folder and press **Options**.
2. Scroll to the **Restore Defaults** option and press **Select** and then select the **Restore Folder Defs.** and press **Select**.

To restore all folders:

When all the folders are restored, the **DGNA** folder is emptied of talkgroups, and the radio will reboot on completion of restoring the folders.

1. From the folder list press **Options**, then scroll to the **Restore Defaults** option and press **Select**.
2. Scroll to the **Restore All Defaults** option and press **Select**. Press **Select** to confirm the request to reset all folders.

Viewing attached groups

You can quickly view all the talkgroups that the radio is currently attached to (scanning). Only those talkgroups in the generic, **Background**, **DGNA**, **Always Attached** and **Smart Call** folders are displayed.

1. Press the **Mode** key (once) to open the current folder. Press **Back** to navigate back 'up' the folder list.
2. With the folder selected (highlighted) press **Options**, then select the **Attached Groups** option and press **Select**.

Use the **Up and Down** navigation keys to scroll through the list of attached talkgroups.

Quick Folders

You can quickly change to a different folder by pressing a customised **Quick Folder** soft key. Your radio may be customised for up to 5 Quick Folders (Folders 1-5) for each operating mode (TMO and DMO). Each Quick Folder is assigned to a soft key on the keypad.

You can choose which frequently used folders to assign to your Quick Folders (if customised). You can view the folders that are assigned as Quick Folders, however no talkgroup information is displayed (you will need to open the folder to view the talkgroup information).

To assign a folder as a Quick Folder:

1. Press the **Mode** key (once) to open the current folder, then press **Back** to navigate back 'up' the folders list.
2. Select the folder you want to assign to a Quick Folder. Press **Options**, scroll to the **Set Quick Folder** option and press **Select**.
3. Scroll to the Quick Folder (Folders 1 to 5) you want to assign this folder to and press **Select**.

To view your Quick Folders:

1. Select **Menu > Groups > Quick Folders**. Select the Folder (1 to 5 depending on customisation) and press **Select** to view the folder assigned as this Quick Folder.

Scanning ON/OFF



Scanning of talkgroups (those that are always scanned or are background talkgroups) in the current selected folder and the **Background** folder can be enabled and disabled. If scanning is disabled, the radio will ignore incoming calls on these talkgroups. Your current talkgroup is always scanned.

1. Select **Menu > Groups > Scanning ON/OFF**.
2. Press **Toggle** (or the **Select/Send** key) to enable/disable scanning.

Contacts

Details of regularly used contacts are stored in a phone book. The phone book has a series of folders labelled **Menu**, **Search**, **All** and **Personal**. Your radio may have additional folders containing contacts programmed into your radio during customisation.

The **Personal** folder contains contacts you create (personal contacts). This folder only appears when you create your first personal contact. The **All** folder contains both personal contacts and contacts programmed into your radio.

Each contact can have up to six associated numbers. A maximum of 6000 numbers can be held in the phone book. The icon next to each contact indicates the dial mode, a radio  or to a  telephone, of the first number associated with it.

Contacts are arranged in a series of up to 64 folders including the following:

- **All** — contains all contacts in the Phone book
- **Menu** — contains options to create and delete contacts in your Personal folder
- **Search** — allows you to search the entire Phone book for contacts and numbers. Initially lists the names of all the folders in the phone book and the number of contacts in each folder.
- **Personal** — contains contacts you create. This is the only folder you can edit.

 **NOTE:** The **Personal** folder is hidden until you create your first personal contact.

To open the Phone book, select **Menu > Phone > Contacts**.

Searching and filtering contacts

You can search the entire phone book for contact names and numbers, or filter the contacts within a folder by entering a search string into the **Search Bar** at the top of any folder (except Menu):

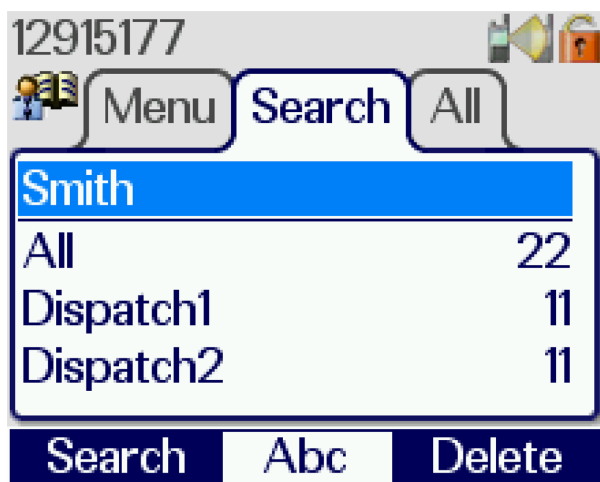

When the search is complete:

- the **Search** folder lists folders containing at least one entry containing the search string, and the number of entries in those folders. You can open any of the listed folders.
- all other folders are filtered to show their matching entries above a dotted line. All non-matching entries are listed below the dotted line.

Spaces in a search string 'split' it into separate strings. Search attempts to match each string in sequence.

To search for contacts and numbers within the phone book:



1. Select **Menu > Phone > Contacts**. Navigate to the **Search** folder.
2. Press the **Up** navigation key to open the Search Bar.
3. Enter a search string (see **Text entry** on page 64) and press the **Search** context key.
4. When the search is complete, any folder containing a possible match to your search (and the number of possible matches within that folder) appear in the **Search** folder. To open a folder, select it and then press the **Open** context key.
5. To clear the search string, press the **Delete** context key to delete each character in the search string, then press the **Cancel** context key, then the **OK** context key.

To filter contacts within a folder:

1. Open the folder.
2. Press the **Up** navigation key to open the Search Bar.
3. Enter a search string (see **Text entry** on page 64), then press the **Filter** context key.
4. Any contact in the folder that is a possible match to your search criteria appears at the top of the contact list. To view the contact's details, select the contact and press the **Open** context key.
5. To clear the search string, press the **Delete** context key to delete each character in the search string, then press the **Cancel** context key, then the **OK** context key.

View contact details

1. Select **Menu > Phone > Contacts**.
2. Navigate to the contact you want to view details of then press the **>>Open** key.

The contact numbers associated with the selected name are displayed. The icon next to each number indicates its dial mode (for example, to a radio  or to a  telephone).

To return to the original folder, press **Cancel** or the **Cancel/Home** key.

Creating contacts

Contacts you create are added to your **Personal** folder.

To create a contact:

1. Select **Menu > Phone > Contacts**.
2. Navigate to the **Menu** card and select **Create Contact**.
3. Enter the contact name (see **Text entry** on page 64) then press the **Save** context key.
4. Select a dial mode for this contact, either TETRA Network (default) or telephone/mobile network.

To change the dial mode, press the **Up** navigation key to select the dial mode line then use the **Left** or **Right** navigation keys to switch dial modes. Press the **Down** navigation key to continue entering the number.

If the message **Wrong number type** appears, change the dial mode or check that the length of the number is between 5 and 8 numbers.

5. Enter the number (see **Text entry** on page 64) then press the **Save** context key.
6. To add more phone numbers for the contact select **Add Next Number** and repeat the previous step.

To add further contact numbers to a saved contact, open the contact and select **Add New Number** at the end of its numbers list.

7. To return to the Personal folder press the **Cancel** context key or press the **Cancel/Home** key.

Editing contacts

You can edit (and delete) contacts in the **Personal** folder of the Phone book.

To edit personal contacts:

1. Select **Menu > Phone > Contacts** and then select the **Personal** folder.
2. Navigate to the contact you want to edit, then press **Open**.

To edit the name:

1. Select the name and then press **Edit**.
2. Make changes as required, then press **Save**.

To edit a number:

1. Select the number and then press **Options**. Select **Edit** and press **Select**.
2. Make changes: to add additional digits press the number keys; to delete digits press the **Left** navigation key.
3. After making changes press **Save**.

To delete a contact:

1. Select the contact and press **Open**.
2. Press **Options**.
3. Select **Edit > Delete contact**, then press **Select**.

Delete all contacts

You can delete all contacts in your Personal folder.

You can also delete individual contacts or numbers associated with them, see **Editing contacts** on the previous page.

To delete all contacts

1. Select **Menu > Phone > Contacts**.
2. Navigate to the **Menu** card then select **Delete User Contacts**.

Calls

The various types of voice and data calls that are supported by your radio, and the acoustic and visual alerts that accompany a call, depend on your radio's customisation.

Call types

Sepura radios support the following voice- and data call types:

Voice call types

Voice call type	Description
Group	A call between you and a group of other radio users in your attached talkgroup. A group call is always a half-duplex call. Users can join and leave the call at any time. Group calls are initiated by pressing the PTT button. See Talkgroups and folders on page 35.
Individual	A call to another user or dispatcher in the TETRA network, or to an external telephone subscriber via the Gateway. Full-duplex and half-duplex calls are supported. Individual calls to outside the TETRA network can be made between a terminal or a dispatcher and a telephone subscriber in a network to which the TETRA network has a gateway interface. These calls are always full-duplex. A full-duplex call is one in which both parties can speak at the same time. The Select/Send and Cancel/Home keys are used to initiate and end calls. In a half-duplex call only one person can speak at a time and needs to press the PTT button.
PBX	A call to a user on a private branch exchange (PBX). This call needs to be set up by your service provider and allows you to call a person by dialling their extension number (preceded by a programmed digit used to dial the exchange).
PSTN	A call to a user on a the public switched telephone network (PSTN).
Broadcast	A special type of group call, which is received by all terminals in the system (system-wide broadcast call) or by a specific group. The originator of a Broadcast call is usually a dispatcher. The receiving members cannot talk.
Transmit Only	A customised type of group call, where a call you make on a transmit-only talk group can only be received by an authorised dispatcher. Other users in the group cannot listen to the call.



Voice call type	Description
Quick Call	A special individual call configured on a soft key to request help or information from a pre-configured individual or talkgroup destination in a non-emergency situation. Quick calls can also send status and position reports. They can have a call priority that is different from the calls normally set up using the PTT or the Select/Send key.
Smart Call	A special individual call made in Smart Call mode which allows you to make group or broadcast calls to specific talkgroups without the need to notify the network about the talkgroup change. Smart Call mode is initiated from a configured soft key. Smart call priority can have a call priority value from 0 (undefined) to 15 (pre-emptive priority 4, emergency) in TMO and to a value from 0 (undefined) to 3 (Emergency pre-emptive priority call) in DMO.
Alarm Call	The Alarm Call has the highest call priority in TETRA. Usually initiated by pressing the Emergency Button. Alerts all other radio users on the talkgroup of the emergency situation.

Data call types





Data call type	Description
Individual full-duplex Circuit Mode Data	Circuit Mode data calls have a very short transit delay and so are suitable real-time services
Status Message	A Status message may have 65536 possible status values. Of these, value 0 is defined to mean 'Emergency,' values 1–32767 are reserved, and values 32768–65535 are available for network or user-specific definition.
SDS Message	A user-defined message that can be sent by individuals and received by individuals and talkgroups.
Packet Data	TETRA Packet Data extends TETRA to act as an IP subnet. This enables application programmers to build their applications in a well-standardised environment.

Call History

The Call History records up to 20 recent individual calls. It can be customised to display Incoming Calls or Outgoing Calls or both sets of call types in a list.

The following icons are used to distinguish different types of  TETRA and  PBX/PSTN call events:

Icon	Description
	Received TMO call

Icon	Description
	Sent TMO call
	Missed call. Call was not answered or cleared.
	TETRA Alarm Call
	Received TETRA DMO Call
	Sent TETRA DMO Call

The call history is deleted if you do not switch off your radio correctly (using the **Mode/Power** key).

To display the call history

Select **Menu > Phone > Call History**.

To display the call information

Select a call in the call history list then press **Open**.

To make a call from call history

See **Individual calls** on the facing page.

Group calls

Group (**point-to-multipoint**) calls are calls where you talk to other users within a nominated group of radio users (a talkgroup). In a group call only one person can talk at any one time (known as **half-duplex** mode).

During group calls the microphone at the top of your radio is active and all received audio is routed to the loudspeaker.

Making a group call

1. Press and hold the **PTT** button and speak into the top microphone.

The LED changes to solid red to indicate that your radio is transmitting, and an audible tone is heard and your radio status text changes to 'Talk'.

2. When you have finished talking, release the **PTT** button and listen to audio received, through the loudspeaker.

The LED changes to solid green whilst the group call is active and your radio status text changes to 'Group Call'.

3. When you have finished your call, press the Clear context key.

You can also clear the group call by pressing:

- Clear Call soft key (if customised)
- Cancel/Home key

Receiving a group call

When a group call is received, your radio status changes to 'Group Call'. The name of the talkgroup, talkgroup folder and the caller's ID are displayed.

Individual calls

Individual calls (**point-to-point**) are private calls between you and one other person. You can make individual calls in two modes:

- individual calls (half-duplex mode)—where only one person can talk at a time using the PTT button.
- individual 'phone' calls (full-duplex mode)—where both parties can talk simultaneously. Use the Select/Send and Cancel/Home keys to initiate and end the call.

During phone calls the bottom microphone (behind the keypad) and the earpiece are active, allowing you to hold your radio against your head like a telephone handset or a GSM telephone.

When an individual call is received, your radio sounds an audible alert and displays the identity of the caller (if the contact is stored in your phone book) or the ISSI of the caller.

Privacy mode

You can press a customised Privacy Mode soft key before dialling or during a call to prevent interruptions from other calls during important or sensitive call. When you have Privacy Mode enabled, calls made to your radio are marked as missed calls (see **Call History** on page 55).

Making individual calls (half-duplex mode)

Calling a contact:

1. Select **Menu > Phone > Contacts** to open the contacts menu.
2. Navigate to a contacts folder (such as the *All* folder) and select your contact. Press the **Open** context key, then choose the phone number.
3. Press the **PTT** button to initiate the call (or press **Options**, select **Dial** then press **Select**).

When the call is connected (the tri-colour LED illuminates green and a confirmation tone sounds).

4. To speak, press the **PTT** button; release the PTT button to listen.
5. To end the call, press the **Clear** context key or the **Cancel/Home** key.

If your radio has been customised with a single dial mode for TETRA, PBX and PSTN numbers, the dial mode icon cannot be changed.

Calling by dialling:

1. From the Home Screen, dial the number of the person you are calling.
2. Press the **PTT** button to initiate the call (or press the **Call** context key).
3. To speak press the **PTT** button; release the PTT button to listen to the other radio users.
4. To end the call, press the **Clear** context or the **Cancel/Home** key.

Receiving individual calls (half-duplex)

1. Press the **PTT** button to answer the call or the **Clear** context key to reject the call.
2. To end the call, press the **Clear** context key or the **Cancel/Home** key.

Making individual phone calls (full-duplex mode)

Calling a contact:

1. Select **Menu > Phone > Contacts** to open the contacts menu.
2. Navigate to a contacts folder (such as the *All* folder) and select your contact. Press the **Open** context key, then choose the phone number.
3. To initiate the 'phone' call, press the **Select/Send** key then select **Dial** (or select **Options > Dial**).
4. To end the call, press the **Clear** context key or the **Cancel/Home** key.

If your radio has been customised with a single dial mode for TETRA, PBX and PSTN numbers, the dial mode icon cannot be changed.

Calling by dialling:

1. From Home Screen, dial the number of the person you are calling.
2. Press **Send** or press the **Select/Send** key to initiate the call.
3. To end the call, press **Clear** or press the **Cancel/Home** key.

If your radio has been customised with a single dial mode for TETRA, PBX and PSTN numbers, the dial mode icon cannot be changed.

Hands-free mode

If you are using a full-duplex audio accessory, simply press the **Select/Send** key and continue fully hands free.

Receiving a phone call

When an incoming phone call is received, your radio sounds an audible alert and displays the identity of the caller (if the contact or number is stored in your phone book).

1. Press the **Accept** context key or the **Select/Send** key to answer the call. Press the **Reject** context key or the **Cancel/Home** key to reject the call.
2. To end the call, press the **Clear** context key or the **Cancel/Home** key.

Your radio can be customised to answer calls automatically after a set time period, exactly as if the **Accept** context key or the **Select/Send** key had been pressed. If the time period is set to zero the call may be answered before any alerts are audible.

Answering phone calls in half-duplex mode

You can answer an incoming full-duplex (phone) call as a half-duplex call. This is useful, for example, where a full-duplex call could pick up too much background noise for clear communications.

1. Press the **PTT** button to answer the call in half-duplex mode.
2. Continue as for Group calls and individual half-duplex calls:
 - To speak press and hold the **PTT** button and speak into the microphone.
 - To listen release the **PTT** button and listen to audio received through the speaker.
3. To end the call, press the **Clear** context key or the **Cancel/Home** key.

Broadcast calls

Sometimes it may be necessary for your Dispatcher to make a high-priority broadcast (also known as a Site Wide Call) to all network users. These calls take priority over any lower priority on-going calls, and you cannot respond to them: pressing the PTT key has no effect during a broadcast call.

During a broadcast call the display changes to 'Broadcast Call' and the  Broadcast Call icon is displayed.

Missed events

The Missed Events screen shows the number of Messages, Calls and Callouts that have been missed. Items in **Bold** are unread.

If your radio has the user profile **Group Focus** selected, any calls to it are not recorded as Missed Calls. See **User profiles** on page 93.

To open the list

Press the Missed Events key (usually the top-right-front soft key under the blue LED or the appropriate soft key if a different one has been customised) from any screen.

To close the list

Press the **Cancel** context key.

To view the message, call or Callout information

Select the required option from the list using the **Up** and **Down** navigation keys.

To clear all messages or events

1. Display the Missed Events box. (Press and hold the Missed Event soft key. A pop-up box is displayed.)
2. Use the **Up** and **Down** navigation keys to highlight the required option then press the **Select** context key.

Quick Calls

A Quick Call allows you to request help or information in a non-emergency situation.

To initiate a Quick Call

1. Press a pre-configured soft key.
2. Press the PTT to transmit.

Depending on the configuration this causes all or some of the following to happen:

- if your radio is in Smart Call Mode it reverts to Group or Individual Mode (see **Smart Calls** below).
- your radio sets up a voice call to a programmed recipient which can be individual or talkgroup
- your radio sends up to two Status messages
- your radio sends a position report

Quick Calls cannot be made from a radio which is making or receiving an emergency call or if your radio is in Transmit Inhibit mode. See **Emergency operation** on page 26 and **Transmit Inhibit** on page 75.

Smart Calls

A **Smart Call** is a high priority group or broadcast call to a specific talkgroup. This can be useful, for example, where you need to make an announcement to everyone in the vicinity of an incident, not just those in your selected talkgroup.

The radio supports two separate **Smart Call Modes** (A and B) associated special folders **Smart Call 1** and **Smart Call 2** respectively. Each Smart Call Folder can be pre-configured with up to 75 talkgroups.

You initiate a Smart Call by switching to Smart Call mode, then you press the **PTT** to transmit to a chosen talkgroup in the Smart Call Folder.

Broadcast calls cannot be made from a radio which is in DMO. Attempting to make a Smart Call in DMO initiates a group call to the attached talkgroup.

Make a Smart Call

1. Open the Smart Call menu either of the following:

- Press a preconfigured soft key.
- Use the **Speech Call Settings** menu (see **Speech call settings** below).

2. Select mode **Smart Call A** or **Smart Call B**.

Your radio goes into Smart Call Mode. The tri-colour LED flashes amber and the active Smart Call folder is displayed.

3. Select the required talkgroup in the current Smart Group Folder by .

4. Use the **PTT** (or press the **Select** context key or the **Select/Send** key) to transmit to the chosen talkgroup.

To leave Smart Call Mode

1. Open the Smart Call menu either of the following:

- Press a preconfigured soft key.
- Use the **Speech Call Settings** menu (see **Speech call settings** below).

2. Select **Group** or **Individual**:

- **Group**—returns you to your previous talkgroup
- **Individual**—allow you to make an individual call by dialling

Speech call settings

The Speech Call Settings option is not available if your radio is in **Transmit Inhibit** on page 75.

1. Select **Menu > Groups > Speech Call Settings**.
2. Select one of the options.

Modifying your call setup

Under certain circumstances, the type of a call which is being initiated by your radio may be modified by the network or by the recipient of the call. For example, you might make a group call, but the actual call being established might be converted to an individual call to a dispatcher.

This feature is typically used by network administrators to provide centralised control over certain services (e.g. customising all the radios so that Alarm Calls are all the same type and destination, allowing the network to decide what type of call is made and the destination whenever an Alarm Call is initiated).

When your call is modified you are alerted with specific visual and acoustic alert indications, to make you aware that a new type of call is being connected. The call continues as per any normal call of the new type, and the icons and information elements displayed inform you about the type of the ongoing call.

Once the call is established, the characteristics of the new call are the same as those of any call of that type. For example, if the new call is half-duplex, you need to press PTT before starting to speak, releasing the PTT allows other parties to take the speech item, and the top microphone and half-duplex loudspeakers are used.

When a radio is worn attached to your body, a half-duplex to full-duplex call modification can be difficult to handle (since the latter is a telephone-type call). To overcome this, your radio can treat the full-duplex calls (resulting from a half-duplex call modification) as if they are half-duplex calls, i.e. using PTT before speaking and releasing it to hear the other party. (**Making individual phone calls (full-duplex mode)** on page 58.)

Changing the behaviour of the PTT during TMO group calls

Your radio may be customised to allow you to talk back on your TMO selected group even if you are currently receiving a group call from another talkgroup being scanned by your radio.

When enabled, pressing the PTT when in a received group call will start a new call on the radio's selected talkgroup, allowing you to participate in that call whilst monitoring your current scanlist activity.

There are two options:

- **To selected group**—when the PTT is pressed in a received group call to a scanned group (not the selected talkgroup), the radio leaves the existing call and starts a new call to the scanned talkgroup.
- **To received group**—when the PTT is pressed during a received group call, the radio transmits in the current call.

If the PTT behaviour is set to the '**to selected group**' option, and the radio is in a group call from a scanned talkgroup that is not the currently selected talkgroup, an icon  appears in the Call Information Box. When the radio leaves the scanned group, to start a call to the selected talkgroup, the icon is not displayed.

The behaviour of the PTT button can be set for all group calls using the **PTT Behaviour** option available from the **Options** menu. Alternatively, you can override the default setting during a group call by pressing the **PTT** context key (which toggles the two options) and select the PTT behaviour that allows you to respond to the call. Your radio provides a notification message to show the change of PTT behaviour (either '**to selected group**' or '**to received group**'). When the call is terminated, the behaviour of the PTT button reverts to that selected using the menu option.

If your radio is operating in Gateway mode, the radio can only respond to group calls in the selected talkgroup (**to selected group**).

To set the PTT behaviour using the menu:

1. Select **Menu > Options > Settings > PTT Behaviour**.
2. Select the PTT behaviour (**To received group** or **To selected group**), then press the **Select** context key.

To change the PTT behaviour during a group call:

1. When the group call is in progress, press the **PTT** context key. Select the PTT behaviour and press the **Select** context key.

Text entry

Writing and editing text on your radio is similar to most Smartphones. **Text edit** mode is automatically activated when you select certain functions, such as creating a message or adding a contact to your phone book.

To enter characters:

Press a key repeatedly to highlight a character in its Character Selection Box at the bottom of the screen, then press the **Select** context key (or wait for the character to be auto-inserted).

When you have finished entering characters select **Cancel** to close the Character Selection Box.

To delete a character:

To delete the character to the left of the cursor press the **Delete** context key.

To enter special characters:

To insert punctuation (**full stop**, comma, or **semi-colon**) press zero (**0**) repeatedly until the symbol is highlighted in the Character Selection Box, then press the **Select** context key (or wait for the character to be auto-inserted).

To insert a **space** press **1** (on the keypad).

To insert symbols press the hash(**#**) key repeatedly until the symbol is highlighted in the Character Selection Box, then press the **Select** context key (or wait for the character to be auto-inserted).

To change the character set:

Press the Star (*****) key during text entry.

Cursor movement

When you enter text the cursor advances automatically. You can also move the cursor character by character or to the start or end of a sentence using the navigation keys.

Cursor Movement	Description
Move one character at a time	Press the Right or Left navigation key.
Move to the start of a sentence	Press the Up navigation key.
Move to the end of a sentence	Press the Down navigation key.
Add a space	Press the 1 key.

Character sets

You can use character sets to change the style of the text, and to enter numbers and special characters. The character set can be changed as often as required when entering text. The following character sets are supported:

Character set	Description
Auto-capitalisation (Abc)	The first letter is entered in upper-case, with all following characters in lower-case. New sentences start with a capital letter and end with a full stop (.), question mark (?) or exclamation mark (!) followed by one or more spaces.
Upper case (ABC)	All characters are entered in upper-case.
Lower case (abc)	All characters are entered in lower-case.
Numeric (123)	All characters are numbers.
Special characters(!.@)	You can select special characters such as full stops (.), semi-colon (;) and commas (,) by pressing the 0 key. Further special characters # @ ! " £ \$ % & ' () * + - are available on the # key.
Chinese characters	Simplified and Zhiyan. See "Chinese character sets" on page 1.

The selected character set is indicated between the Context key labels.

Messages

Your radio supports  **status** messages,  **text** (SDS) messages and  **picture** messages. All message types are available from the **Messages** menu.

Message Inbox

Incoming messages are displayed in the **Inbox** with the most recently received messages at the top. Unread messages appear in **Bold**. The Inbox can store up to 50 messages. When the Inbox is full, unsaved older messages are automatically deleted when new messages are received. If you want to keep a message, you must save it.

If your radio is configured to show messages in tabs, the most recent message appears on the last numbered tab, for example if there are 5 messages in your Inbox a new message will appear on tab number 6. If you want to read older messages use the navigation keys to scroll through the message tabs. Unread message appear on black labelled tabs.

To keep the Inbox to a manageable size it is recommended that messages are deleted or saved after reading them. See **Saved messages** on page 69.

When a new message arrives

- the  **New Message** icon appears to show there is a new message in the Inbox.
- the radio vibrates
- the tri-colour LED flashes amber
- the blue LED flashes periodically ('missed event')
- the display flashes periodically ('missed event')
- if specified in the message, the text of the message (SDS message) or image (Picture message) is displayed on the screen as soon as it is received









To open the Inbox:

Choose one of the following methods:

- Press a customised soft key
- Select **Menu > Messages > Inbox** to open the Inbox.
- Press and hold the **Mode** key and **View unread messages**.
- Press the Missed Events key from any screen then press **Messages**.
- Press a context key assigned as a shortcut to your Inbox.

Message icons

Various icons are used to identify the type of message received:

Icon	Description
	Status message
	SDS message (unread)
	SDS message
	Broken message: there was a problem receiving the message. Its contents are lost or damaged.
	Saved Messages is nearly full to capacity [customisable]
	SDS message with Paging Alert (unread)
	SDS message with Paging Alert
	Picture message (unread)
	Picture message

Inbox operations

You can perform a number of functions from the Inbox. With a message selected, press the **Options** context key to perform one of the following functions:

- Open the message
- View the message details (See **View message details** below.)
- Reply to the message (not picture messages)
- Forward the message to a contact (not picture messages)
- Save the message (See **Saved messages** on page 69.)
- Delete the message

Opening messages

To open a message:

1. Open your Inbox (see **To open the Inbox:** on the previous page).
2. Select a message then use **Options > Open**.
3. Alternatively you can press the **Select/Send** key.

View message details

You can view the details of received messages.

To view message details:

1. Open your Inbox (see **To open the Inbox:** on page 66).
2. Select a message then use **Options > Details**.
3. To exit the Details screen press **Cancel**.

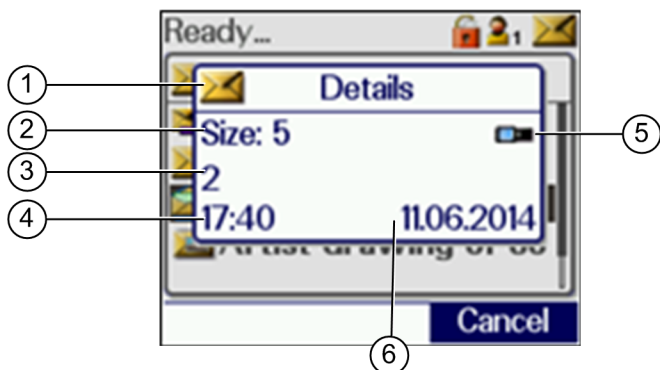

Item	Description
1	Message location (Inbox)
2	Size. Note: this is a relative measure of the message size (not number of characters). You can use Size to decide which message(s) to delete if Saved Messages becomes full (see Message Inbox on page 66)
3	Sender
4	Time received
5	Dial mode
6	Date received

Reply to a message

To reply to a message:

1. Select **Options > Reply**.
2. Create your response (see **Text entry** on page 64.)
3. When you have finished, press **Send**.
4. Select a recipient:
 - a. **Send to Default**—send to message sender
 - b. **Send to Group**—send to your current talkgroup
 - c. **Phonebook**—send to a contact in your phonebook
 - d. **Dial**—send to a number you dial
5. Press **Send**.

Open a URL in a message

Open the message then select **Options > Open URL**.

A text message may contain a URL which you can open in the WAP Browser.

If your radio has been customised to do so, URLs in text messages can open automatically in the WAP Browser when they are received.

Saved messages

You can save up to 50 messages in your Saved messages folder. When the remaining space is insufficient to save a particular message, an error is displayed which indicates the amount of space required to store the current message. Delete one or more messages to clear some space for new ones to be saved.

Saved Messages can be lost if the radio is not correctly switched off when powering down (see **Power off** on page 20).

To save a message:

1. Open the message (or select it in the Inbox).
2. Select **Options > Save**.

A message indicating that the message has been stored is displayed.

To view saved messages:

Select **Menu > Messages > Saved Messages**. Use the navigation keys to scroll through the list of messages.

Alternatively press a context key you have assigned as a shortcut to Saved Messages.

To delete saved messages:

1. View Saved Messages (see **To view saved messages:** above).
2. Select **Options > Delete**.
3. Select a delete option:
 - To delete the selected saved message select **Delete Message**
 - To delete all saved messages select **Delete All**

Create a text message

1. Select **Menu > Messages > Create Message**. An empty message box appears.
2. Enter your message text (see **Text entry** on page 64).

3. EITHER:

- send the message immediately
- save the updated message

To return to the top level menu screen, either wait for the inactivity timer to expire, or press and hold the **Cancel/Home** key, or press and hold the 'clear' soft key.

To send the message immediately

See *Sending messages* below.

You can set an option to confirm that the message has been delivered, see **SDS report request** on page 72.

To save the message

Select **Options > Save**.

To edit a saved text message

1. View Saved Messages and select the saved message.
2. Select **Options > Edit**.
3. Edit the message as required. (See **Text entry** on page 64.)
4. EITHER:
 - send the message immediately
 - save the updated message

To send the message immediately

See *Sending messages* below.

To save the updated message

Select **Options > Save**.

Sending messages

You can send text (SDS) and status messages to:

- the currently selected talkgroup
- the default destination customised in your radio (for example, the message sender)
- a Phonebook entry
- a destination you key in

For setting default destination see **Set default destination** on page 70.

1. Choose one of the following methods:
 - Select a saved text message
 - Select a status message from the Send Status List
 - Create a text message
2. Select **Options > Send**.
3. Select a destination (see below):

Send to default destination

Select **Send to Default** then select **Send**. The message is sent and the radio returns to the message screen.

Send to current talkgroup

1. Select **Send to Group**. The current talkgroup is shown.
2. Select **Send**.

Send to a Phonebook entry

1. Select **Phonebook**. Your Phonebook opens.
2. Select your contact and press **Open**.
3. Select the phone number. (Contacts can have multiple phone numbers).
4. Press **Send** to send the message.

While you are selecting the address for a message you cannot make outgoing calls to Phonebook.

Send to a dialled destination

1. Select **Dial**.
2. Key in an individual address (ISSI, Individual Short Subscriber Identity) in the dial box.
3. Press **Send** to send the message.

Send a status message

To send a status message, choose one of the following methods:

Soft key (Quick Status message)

Press a soft key. Messages sent from soft keys are called **Quick Status messages**.

During a Group Call with the call dialogue screen displayed, you cannot send Quick Status messages using the **Select/Send** key or the **Cancel/Home** key. Instead, first press the **Down** navigation key to clear the call dialogue screen, or exit the call.

Mode key + Navi-knob

1. Press the **Mode** key twice, rotate the **Navi-knob** to scroll through the status messages then select **Send**.
2. **Select** a destination.

Menu

1. Select **Menu > Messages > Send Status**.
2. Use the **Up and Down** navigation keys to highlight the status and then select **Options > Send**.
3. **Select** a destination.

Edit status messages before sending

You can edit the text label of a status message prior to sending it. When the message is edited, it is sent as a text message, rather than as a status message code.

With the status message selected, press **Options** and then select **Edit**. Enter your text before sending the message.

The **Edit** option is only available when you open a status message from the menu.

SDS report request

You can request a Delivery Report and/or a Read Report when you send an SDS (text) message. These cause a pop-up box to open when sent messages are successfully delivered and read respectively.

1. Select **Menu > Messages > SDS Report Status**.
2. Navigate to a report type and press **Toggle** to toggle the report on (ticked) and off.

Set default destination

You can enter and update the default destination address that your radio offers when you send a status or SDS message. This can be either a talkgroup or an individual.

1. Select **Menu > Messages > Status Destination**.
2. Select **Options** (or press the **Select/Send** key) then select **Edit**.
3. Select Dial or Phonebook:
 - select **Phonebook** to open the Phonebook and choose a contact (**Contacts** on page 50)
 - select **Dial** to enter the required number directly from the radio keypad.

4. Press **Save** or the **Select/Send** key to save the number (or press **Cancel** or the Cancel/Home key to cancel it and return to the previous number).

Picture messages

Picture messages

Your radio can receive picture messages which may have accompanying text. You may also be alerted by an alarm (if specified in the message) and vibration and LED alerts (if customised). (You cannot reply to or forward a picture messages.)

You can press any key to stop the audible alarm.

Open picture message

1. Select a  picture message then use **Options > Open**.
2. Alternatively you can press the **Select/Send** key.
3. To view the image full screen, use **Options > View Image**.

The image and any text associated with it are displayed.

Twist-and-Zoom: you can turn the radio through ± 90 degrees from the normal vertical position to make the image automatically maximise to use the full screen area.

If the image data has been corrupted the  Broken Picture icon is displayed.

Paging alerts

The Paging Alerts feature allows the radio to act as a pager when it is in normal operating mode or when you select a **user profile** which results in the radio appearing to be switched off. (See **User profiles** on page 93.) The Paging Alerts feature is triggered by receipt of a Status message which is automatically displayed.

If there is also an associated SDS message to explain the reason for the Paging Alert this is automatically displayed on the radio. If a call is in progress the Paging Alert interrupts it. The SDS message is marked with an icon  to indicate that it is associated with a Paging Alert.

When the Paging Alert is triggered you hear a discordant two tone alarm and the tri-colour LED flashes amber to indicate that a Status message has been received. To stop the two tone alert press any key.

Your radio can be customised so that a Paging Alert automatically makes it fully operational on receipt of the Status message which triggered the Paging Alert.

Networks

Authentication

Remote User Assignment (aliasing)

If your radio supports Remote User Assignment (RUA) using TETRA Interoperability Profile (TIP) defined procedures and transactions, your presence on the network requires authentication.

RUA allows you to be authenticated onto the network by entering a user identity and optionally a PIN (maximum 7 digit). Once accepted by the system, you can be addressed by your user identity, if aliasing is supported by the system.

At the start of a shift, you can take a pool radio and, after you log in, other radio users on the network can identify you by your user name. TETRA services including individual voice and data (Status and SDS) communication can be set up using your user name (provided your user name and your corresponding user ISSI are in the Phonebook).

Network log on/off may be initiated by your dispatcher.

To log on/off:

Your radio may be customised to request PIN entry log on to the network when powered on. Alternatively select **Menu > Networks > Log ON/OFF**.

A screen appears:

Log On—enter your user ID and password then press **Confirm**.

Log Off—press **Confirm**.

Details—indicates the current log on state of the radio, and displays the user's network identity.

Change Network

If your radio is customised to use other networks, you can manually select a network from a list of configured networks, or allow your radio to automatically use a suitable network when you move into its coverage area.

If your radio is customised for End to End Encryption, the radio may change the End-to-End Encryption status when the selected network is changed. It may also provide a selection of talkgroups on other networks. If a talkgroup is selected that does not belong to the current network, your radio will change network accordingly.

After switching to a different network, make sure that your selected talkgroup is valid for that network. For details of talkgroup selection see **Talkgroups and folders** on page 35.

Your radio can be configured to display the Network Name continuously on the Radio Status Line (RSL), subject to space, when it is idle.

If your radio registers on a **Visited Network** network the  **Migrated** icon is displayed in the Radio Status Line (RSL).

To manually change network

1. Select **Menu > Networks > Change Network**.
2. Navigate to the required network then press **Select** or the **Select/Send** key.

When you manually select a network it remains selected regardless of whether your radio is able to obtain service on that network.

To automatically change network

1. Select **Menu > Networks > Change Network**.
2. Navigate to **Automatic** then press **Select** or the **Select/Send** key.

The Network Name of the automatically selected network is displayed below the **Automatic** option in the list when the radio is able to obtain service.

Transmit Inhibit

Sometimes you may be working in areas that are sensitive to Radio Frequency (RF) signals such as healthcare facilities. To continue operating your radio in these areas, you can set your radio to Transmit Inhibit mode to prevent any RF transmission.

When Transmit Inhibit is activated or deactivated, a status message can be sent confirming the operational state of your radio. You cannot activate Transmit Inhibit when you are in a call.

Alarm Calls initiated in Transmit Inhibit mode are still transmitted.

You cannot select Transmit Inhibit if user profile **Do Not Disturb** is selected. See **User profiles** on page 93.

Your radio automatically leaves Transmit Inhibit mode when you power it off; when powered on again Transmit Inhibit is not activated.

To activate or deactivate Transmit Inhibit mode

1. Select **Menu > Networks > Transmit Inhibit**.
2. Select **Toggle** to toggle Transmit Inhibit on/off.



When Transmit Inhibit mode is activated:

- The Tri-colour LED flashes orange four times approximately every 2 seconds.
- The  Transmit Inhibit icon appears on the status line on the Home screen.

There may be a soft key programmed to toggle Transmit Inhibit on/off. For a list of programmed soft keys refer to the radio's Help (**Menu > Help**).

Adjusting the DMO power transmission level

When you are operating in DMO, Repeater or Gateway modes, you can change the transmission power level that your radio operates at on the network.

The radio operates at a normal transmission level which is predefined. If you change the power level to a setting that is higher than the normal operating transmission level, the icon  appears on the status line. Likewise if you change the power level to a lower transmission level, the icon  appears on the status line.

To change the transmission power level:



1. Select **Menu > Networks > DMO Options** then select either the **DMO Tx Power** option if you are working in DMO on the network or the **Rep/GW Tx Power** option if you are working in Repeater or Gateway modes.
2. Select the power level option, and press the key.

Fallback Mode

If a base station is customised to operate in fallback mode, when network communication is lost any radios using the base station will continue to operate, but with a reduced service. This is known as **Fallback Mode**. The base station broadcasts the loss of communication to all radios which are using it.

In Fallback Mode your radio can only communicate with other radios that are registered on the same site: no inter-site communication is available.

When your radio enters Fallback Mode:

- the radio status bar indicates Fallback Mode and the  warning triangle is displayed momentarily
- the Fallback Mode text box pops up in the centre of the screen for a few seconds showing a customisable text message
- the  RSSI antenna icon flashes continuously
- the tri-colour LED flashes amber intermittently (indicating limited service mode)
- the radio generates a warning tone

When your radio leaves Fallback Mode:

- the radio status bar returns to normal (Ready... or similar)
- the  RSSI antenna icon stops flashing
- the tri-colour LED stops flashing
- a text box pops up indicating normal operation.
- the radio generates a warning tone.

Operating Modes

Your radio supports the following operating modes:

- In **Trunked Mode Operation** (TMO Mode) your radio operates on the network infrastructure supplied by your service provider.
- In **Direct Mode Operation** (DMO Mode) your radio can transmit directly to another radio (antenna to antenna). In DMO mode radio coverage depends on the position of the caller and the receiving radio. When you switch to DMO your radio leaves the network and tunes to the selected DMO talkgroup. See also **DMO Mode** below.
- In **Repeater** mode your radio enables two or more radios operating in DMO mode to communicate over an extended range, automatically relaying voice and messages by operating as a repeater. See also **Repeater Mode** on page 79.

To change operating mode from the Home screen

Press the **Menu** context key, then select **Networks > Operating Mode**. Scroll to the mode (highlight it) and press **Select**.

Alternatively, a soft key may be programmed as a shortcut to this function.

DMO Mode

In Direct Mode Operation (DMO), radios communicate directly with other TETRA radios without using a network. The radios must all switch to DMO and select the same talkgroup, and that talkgroup must use the same channel (frequency). Communications to other users on the network are impossible unless they also switch to DMO and select the same talkgroup.

This means that in DMO, communications to the dispatcher is impossible unless they also switch to DMO and select the same talkgroup, or if they communicate through a **DMO gateway** (see *DMO gateway operation*).

Group calls

DMO supports group calls (see **Group calls** on page 56) which are made and received in the same way as radios operating in TMO. In DMO TETRA Alarm Calls are either sent to the currently selected DMO talkgroup or (if customised) may switch to TMO to make the call. If TMO is unavailable Alarm Calls are made using DMO. See **Emergency operation** on page 26.

Individual calls

Your radio can be customised to allow you to make individual calls to other radios working in DMO which are attached to the same talkgroup. In this case individual calls are initiated by pressing the PTT key.

Your radio can also be customised to allow you to select a **channel only** talkgroup. If you select a channel only talkgroup **your radio cannot make or receive group calls**: it can only make or receive individual calls.

You can enable **Presence Checking** so that your radio checks whether the receiving radio is available to receive when you attempt an Individual call. See **DMO options** below.

Using a DMO gateway

A DMO gateway (or gateway) is a device which allows users working in Direct Mode to communicate with users in Trunked Mode effectively extending the working range of a radio. When your radio is in DMO Mode and it is in range of a DMO gateway the  gateway icon appears and, if customised, an audible alert is generated. You can now make and receive group calls to TMO radios (and to the dispatcher) via the gateway. See **DMO gateway operation** on page 1.

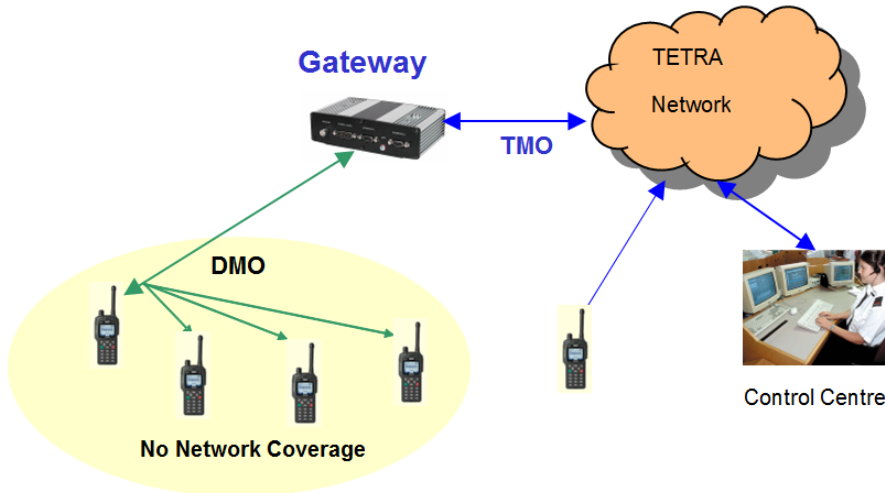

If your radio is outside the range of a gateway, you may still be able to hear the speech of another user who is in range of a gateway and who is involved in a group call via the gateway. In this case the  **Communication Mismatch** icon is displayed to indicate that you cannot take part fully in the call. If you attempt to respond to the overheard speech, any radios within gateway range which can hear you also display a Communication Mismatch icon to tell them that the speech is not being routed via the gateway to TMO users.

Using a DMO repeater

You can extend DMO Mode range by using a DMO repeater (repeater). If your radio detects a repeater the  **DMO Repeater** icon is displayed and your radio can communicate with any other radios in the selected DMO talkgroup which are also within the range of the repeater. See **Repeater Mode** on the facing page.

If a radio is within range of a repeater but for some reason a call cannot be set up through it your radio attempts to set up the call in DMO Mode and the  **Communication Mismatch** icon is displayed to all members of the talkgroup to indicate that there may be members of the talkgroup who cannot take part in the call.

DMO options

You can select the following DMO options:

Presence Check

Specify whether Presence Checking is performed before DMO Individual calls are made. When Presence Checking is On your radio checks whether the intended receiving radio is available and in radio contact before it attempts to set up the call.

GW/Rep Filter

Specify whether your radio uses or ignores any gateway and/or repeater it detects.

In the Gateway/Repeater Filter screen select one of the following options:

No GW/Rep—do not use any gateways and repeaters detected by your radio

Use Repeater—Use repeaters detected

Use Gateway—Use gateways detected

If the radio selects a gateway, a  gateway icon is displayed on the status line. If the gateway stops sending a presence signal it will no longer be detected by your radio.

Repeater Mode

A radio acting as a **repeater** provides a service to other radio users. It extends the range and enhances the reliability of Direct Mode communication compared with basic direct communication between radios.

You can use a repeater to enable communication between radios which are out of range of each other. The following diagram shows radios A, B and C and a repeater which are on the same DMO talkgroup. A, B and C are in range of the repeater. Because of its location, the repeater can pass communications between A, B and C even though they are out of range of each other.

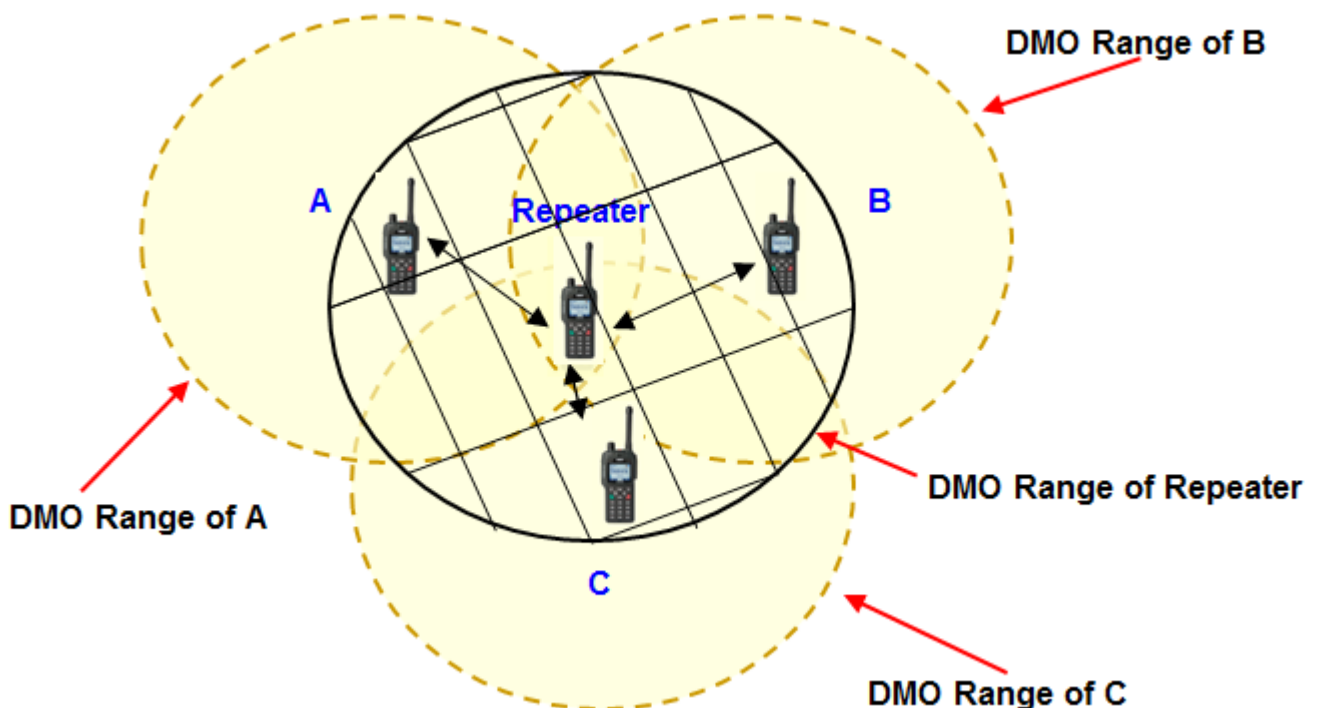

You can also use a repeater to enable communication between two radios which cannot communicate directly, perhaps because their users do not have line of sight with each other.

The following diagram shows radios A and B and a repeater which are on the same DMO talkgroup. A and B are in range of the repeater. Because of its location, the repeater can pass communications between A and B even though they cannot communicate directly.

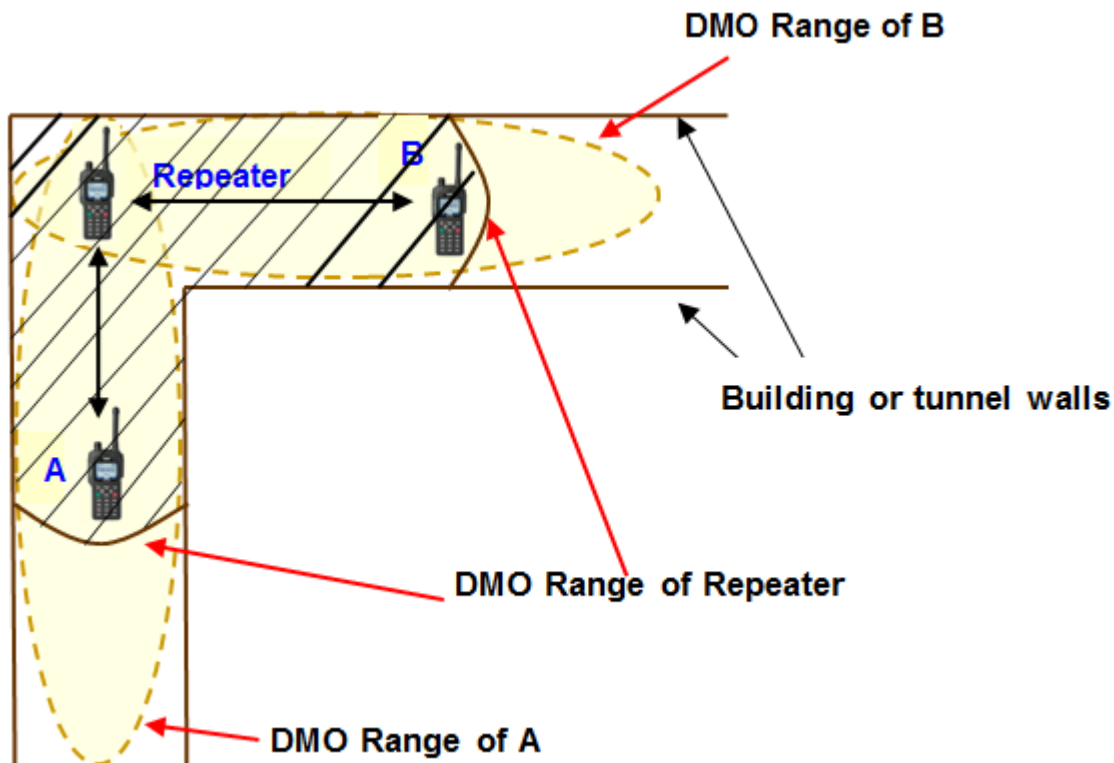

What repeaters cannot do

In Repeater Mode the radio cannot:

- make individual calls
- take part in another group call
- send status or SDS messages
- use the Quick Status feature
- edit text
- use the phonebook
- view the library of pre-defined Status messages

Participating in repeated calls

A radio in Repeater Mode may (depending on its customisation) operate either as a **Standard Repeater** or as a **Repeater with Call Participation**.

Standard Repeater

If your radio is configured to operate as a Standard Repeater you cannot take part in calls which are being relayed through it.

Repeater with call participation

If your radio is configured to operate in Repeater Mode with Call Participation you can take part in the calls which are being relayed through it if the call participants are on the same DMO talkgroup as you. To stop participating in a call, press the **Clear** context key; your radio continues to act as a Repeater.

You cannot switch to Repeater Mode if the radio is in Transmit Inhibit Mode or if the radio has initiated an alarm call (see **Emergency operation** on page 26) which has not been cleared.

If you select Transmit Inhibit Mode while your radio is operating in Repeater Mode, the radio leaves Repeater Mode and it stops functioning as a Repeater.

If you are going to leave a repeater unattended for long periods of time, or as a permanent installation in a remote location, we recommend that you configure it as required (select and attach the required Direct Mode talkgroup) and then power the radio off. This will save the configuration; each time the radio is powered on again, it will re-start with the saved configuration. This will ensure that the radio is always running with the correct repeater configuration even if it turns on unexpectedly after circumstances such as power failures.

Switching to Repeater Mode

To switch to Repeater Mode see **Operating Modes** on page 77.

Before you can use the radio as a repeater you must select a Direct Mode talkgroup.

Changing talkgroups in Repeater Mode

You can change talkgroups while your radio is operating in Repeater Mode in the usual way (see **Talkgroups and folders** on page 35.)

If you change to a different DMO talkgroup it may (depending on the customisation) terminate any calls active through the repeater.

Using the Emergency Button in Repeater Mode

If you use the Emergency Button when your radio is operating in Repeater Mode, any calls that are currently active through the repeater will cease. When the Alarm Call is subsequently cleared, the radio may not necessarily remain in Repeater Mode.

Repeater states

A radio acting as a repeater can enter several states of operation, depending upon the status of calls through the repeater and whether it has detected other users of the direct mode channel. These states are reported as the following top level screen messages:

Message	Description
Ready: Repeater	The repeater is ready and has no calls in progress
Busy DMO Channel	The repeater has detected that the DMO channel is being used. In this case repeater operation is suspended.
In Call: Repeater	A call is in progress through the repeater.
Talk Repeater	Participating in a call and transmitting

Callout alerts

Your radio can receive Callout Alerts sent over the network to inform you of incidents. When a Callout Alert arrives the radio sounds an audible alarm and a Callout message is displayed on the screen. To silence this alarm press any key. A voice call may also be initiated. Your radio may also be customised to alert you of Callouts in other ways (such as vibrator alert and/or a flashing LED alerts).

When it receives a Callout Alert your radio goes into **Protected Callout Mode** (in which many features are disabled) for a set time period or until you respond to or acknowledge the Callout message. This mode is designed to stop you getting distracted and to focus your attention on an incident.

To view Callout messages

Press **Menu** then select **Phone > Callout**.

If Callout messages have been received they are listed with **Callout icons**.

To see the options for a Callout

- Highlight a Callout and press **Options** OR
- press the **Select/Send** key to activate the first option in the Options menu. (The  Select/Send Key Shortcut icon between the Context keys indicates that this shortcut is available.)

Open – view the Callout message plus more information associated with the message dialogue

Accept – indicate you are accepting the Callout

Reject – indicate you are rejecting the Callout

User Response – compose a free-form text message to send to the Callout originator
[customisable]

Delete – delete one or more Callouts

Details – view the details of the Callout message

Status – send or update your current Availability status. The Callout screen indicates that an  Availability Status message has been sent. [customisable]

Responding to Callouts

When you respond to a Callout your radio may automatically send a message (if programmed in the radio) or you can select a message from a list or select **User Response** (if customised) to compose and send a free-form text message.

Callouts requiring a response

Some Callouts require a response. The following responses are possible:

Accept

Press **Accept** to indicate that you intend to act on the Callout (or select **Accept** from the pop-up menu displayed from the Left or Right navigation key. If only one acceptance message is programmed in your radio an informative message is displayed to show that it has been sent to the originator of the Callout. If multiple messages have been programmed, select one of them and press **Select** to send it. Alternatively (if customised) you can compose and send a free-form text message.

Depending how the Callout has been configured it may either exit once the acceptance message has been sent or it enter an Information Phase during which information may be sent to and received from the originator of the Callout. This could include a pre-set message, a free-form text message or a Callout group call.

Reject

Press **Reject** to indicate you do not intend to act on the Callout (or select **Reject** from the pop-up menu displayed from the Left or Right navigation key. Your radio exits from the Callout and Protected Callout Mode and the top level screen is displayed.

Standby

Select **Standby** to acknowledge receipt of the Callout and to indicate that you are “standing by” for further information before accepting or rejecting. During standby the Callout goes into its Information Phase during which information may be sent to and received from the originator of the Callout. During standby you can also accept or reject the Callout and—if use of the PTT is permitted—make group calls to the Callout group.

During Standby you can view the following Callout message details :

- the ‘Response required’ icon
- the Callout group
- time and date when the message was received
- the severity of the Callout Alert
- the Callout ID
- icons to show:
 - whether the Callout is to a group or an individual
 - whether the Callout is incoming or outgoing
 - whether or not the Callout is End-to-End Encrypted

User Response

Allows you to compose and send a free-form text message to the originator of the Callout.
[customisable]

Callouts not requiring a response

Some Callouts do not require a response. You can respond to or ignore them as follows:

Exit

Press the **Exit** context key to exit the Callout and return to the top level screen. No response message is sent.

Respond

Press the **Respond** context key to display the Information screen offering the various pre-set messages to send from the radio to the originator of the Callout and vice versa. To send one of the pre-set messages select it and press the **Select** context key.

User Response

You can compose and send a free-form text message to the originator of the Callout. When your message is ready to send press the **Confirm** context key. You can continue to respond and send messages as described here until the Callout ends and the top level screen is displayed.

[customisable]

Details

You can view the following Callout message details:

- the 'Response required' icon
- the Callout group
- time and date when the message was received
- the severity of the Callout Alert
- the Callout ID
- icons to show:
 - whether the Callout is to a group or an individual
 - whether the Callout is incoming or outgoing
 - whether or not the Callout is End-to-End Encrypted

Callout Test alert

If you receive a Callout Test Message either respond or cancel the alert:

- to cancel the Callout Test alert press the **Cancel** context key. The Callout exits and the radio displays the top level screen. You can still view the details from **Messages > Callouts**.
- to indicate that you are ready to respond to Callout alerts press **Respond** (or the Left or Right navigation key). The following response options are displayed:

Respond

Press the **Respond** context key to display the Response screen. Press the Right or Left navigation key to view additional options. To send a Test OK message to the Callout originator select it and press the **Select** context key. The Callout Test exits and the top level screen is displayed.

User Response

(If customised) allows you to compose and send a free-form text message to the originator of the Callout. When the message has been sent the Callout Test exits and the top level screen is displayed.

Details

The Details screen is displayed showing:

- the Callout Test icon
- an indication that the Callout Test has been sent to an individual
- the originator of the Callout Test message
- time and date when the message was received
- the severity of the Alert
- the Message ID
- icons to show :
 - whether the Callout is to a group or an individual
 - whether the Callout is incoming or outgoing
 - whether or not the Callout is encrypted

Press the **Back** context key to display the previous screen.

When a Callout ends

When a Callout times out or is cleared by the Callout originator the Callout ends, your radio displays the top level screen and the functionality which had been suspended is restored.

Protected Callout Mode

When it receives a Callout alert your radio goes into **Protected Callout Mode** (and many features are disabled) for a set time period or until you respond to or acknowledge the Callout message. This mode is designed to stop you getting distracted and to focus your attention on an incident.

During Protected Callout Mode you can only do the following:

- Read the current alerting message
- Acknowledge the Callout alert
- Make an Alarm Call
- Switch Transmit Inhibit on/off

- Make a Quick Call (if customised as a higher priority than Callout)
- Switch on Man Down
- React to the Lone Worker prompts. The Lone Worker alarm operates if you do not react.
- Switch the radio off using the Mode key

No calls—apart from group calls allowed by some Callouts—received while your radio is in Protected Callout Mode are connected but their details are saved. To view them after the Callout has ended select the Missed Event menu.

If you receive a new Callout while your radio is already in Protected Callout Mode, the new Callout takes priority and is displayed immediately. The existing Callout is treated as a missed Callout: to view its details after the Callout has ended select **Messages > Callout**. The blue LED flashes and the Missed Call and/or Missed Callout icons display after the new Callout has ended.

Missed Callouts

To view information about the missed Callout select **Menu > Messages > Callout**.

Your radio ignores Callouts received when any of the following functions are active:

- Ongoing Alarm Call (a highest priority call)
- Alarm Call
- Quick Call (when customised as a higher priority than Callout)
- Smart Call 1 (when customised as a higher priority than Callout)
- Smart Call 2 (when customised as a higher priority than Callout)
- Group Focus
- Privacy Mode
- Man Down
- Lone Worker

When the higher priority function ends, the radio notifies you of the missed Callout by sounding an audible alert, flashing a blue LED (missed event) and displaying a  Missed Callout icon.

Callout display







A typical Callout screen looks as follows:



Item	Description
1	Message location (Inbox)
2	Callout type, see <i>Callout icons</i> .
3	Callout group or Callout originator
4	Time received
5	Callout message header text (customisable)
6	Information icons
7	Backdrop image (customisable, radios with colour display only). Indicates severity of the Callout.
8	Date received
9	Explanatory text about the Callout
10	Left/Right Navigational keys available for more options

Callout icons

Icon	Description
	Callout Alert message, response required.
	Missed Callout
	Callout Alert message, user response has been sent.
	Callout Alert message, response not required.
	Callout Availability message.
	An information message has been received by the radio.
	An information message has been sent from the radio.

Icon	Description
	Standby Message has been sent from the radio.
	Callout Test message, user response is required. The identity of the sender is displayed instead of the Callout group.
	Callout Test message, user response has been sent.
	The receiving radio and the Callout originator both have End-to-End Encryption active.
	Either the Callout originator or the receiving radio has End-to-End Encryption switched off.
	The Callout is addressed to an individual.
	The Callout is addressed to a group.

Left and Right navigation keys

The  left and right arrow icons are displayed between the Context keys during Protected Callout Mode when there are more options than are shown on the Context keys.

EITHER:

- Press the Left or Right navigational keys to display a menu of the additional options available
OR
- press the **Select/Send** key to action the first item in the menu of options. The  Select/Send Key Shortcut icon is displayed between the context keys to indicate that this shortcut is available.

Group calls to Callout group



While your radio is in Protected Callout Mode the only calls you can make are TETRA Alarm Calls, Quick Calls (if customised as a higher priority than Callout), and, if allowed, group calls to the Callout group. You can only make group calls if PTT use is permitted during the Callout.

For some Callouts your radio can make and/or receive group calls to a specially configured **Callout group** when it is in Protected Callout Mode. This group may be the group the radio is attached to when the Callout is received, or a different group which the radio is configured to connect to on receipt of the Callout or when an acceptance message is sent.

While the PTT is pressed and the radio is transmitting the text “Talk” is displayed in place of “CALLOUT” on the Radio Status Line at the top left of the screen and no backdrop is displayed. When the radio is receiving a group call the ISSI (or shortened ISSI) or identity of the transmitting party is displayed in place of “CALLOUT” on the Radio Status Line at the top left of the screen.

When the Callout has exited, depending on the customisation, the radio either reattaches to the group it was attached to before receiving the Callout, or remains attached to the new group.

Information Phase

Some Callouts do not exit after the initial acknowledgement is sent, but enter an Information Phase when information may be  sent to and  received from the originator of the Callout. Information can include a pre-set message, a free-form text message or a Callout group call. Your radio can also be customised to display a backdrop graphic to indicate it is in Information Phase.

When information is sent (for example “Will Respond”) it is displayed and the  information sent icon displays.

Press the **Exit** context key to exit from the Callout or the **Respond** context key to use an option on the Information screen or press a Left or Right navigational key to display a menu of further options.

For some Callouts, group calls can be made by the radio to the Callout group during the Information Phase if use of the PTT is permitted during the Callout.

The options available during the Information Phase are Information, Accept, Reject, User Response and Details.

Information

Send a pre-set information message. If only one Information message is programmed in the radio you are notified by an informative message confirming that the pre-programmed Information message has been sent to the originator of the Callout.

Alternatively you can select from a list of preconfigured messages. Select **View Response** to check the complete message text before sending it.

Accept

Sends an acceptance message to the originator of the Callout.

Reject

Send a rejection message. You are notified by an informative message confirming that the rejection message has been sent to the originator of the Callout, and your radio exits from the Callout and Protected Callout Mode and the top level screen is displayed.

User Response

Send a free-form text message.

Details

See the following Callout details:

- the ‘Response required’ icon
- the Callout group
- time and date when the message was received

- the severity of the Callout Alert
- the Callout ID
- icons to show:
 - whether the Callout is to a group or an individual
 - whether the Callout is incoming or outgoing
 - whether or not the Callout is End-to-End Encrypted

Features

Your radio can be customised for various advanced features and can have various soft keys assigned to frequently used features.

Privacy Screen

Your radio can be customised to display a picture when the screen is inactive for a specified period of time. This helps protect the privacy of any displayed information. This **Privacy Screen** feature is particularly useful if you are wearing your radio at shoulder level. The normal display reappears as soon as any activity occurs which turns on the back light.

View images

Your radio needs to be fitted with a microSD card if you need to refer to images on your radio, such as maps, product diagrams or photographs, or if you will be referencing WAP sites.

Image details are best viewed in Normal Text Mode. See **Adjusting text and icon size** on page 32.

After fitting, images and WAP sites are uploaded to the card using Radio Manager. During customisation the data is encrypted to prevent undesirable viewing of the data by unapproved persons should the radio or card be lost. Only JPEG images can be used with your radio and images must not exceed 2 mega pixels.

Your radio supports 4 GB cards that must be formatted for the FAT16 file system.

The error No SD Card indicates that your radio is not fitted with a microSD card. The error No Entries indicates that there are no files on the microSD card, or that the card is correctly formatted.

To view images:

1. Press **Menu > Applications > View Images**.
2. Use the navigation keys to select an image. Alternatively use **Quick Search**: press a key on the keypad to match image file names which begin with the letter or characters associated with that key.
3. Press **View**.
4. To view information related to the image you are viewing, press **Details**. Use the Up and Down navigation keys to show any details which cannot be displayed on one screen.

Comments can provide useful information related to the image.

For example:

- if the image was of a missing or wanted person, details could include information about who to contact if that person is spotted, perhaps advice on how to approach them and whether back up needs to be called.
- if the image was of a chemical symbol on the side of a tanker transporting hazardous material, the comments could give advice on what precautions need to be taken when dealing with the incident.

The **date and time** and other details are also shown.

No details are available if the image has been loaded on to the microSD card as a Bitmap.

5. To exit the image, press the **Cancel** context key.

User profiles 1

User profiles are pre-set combinations of alerts and settings on your radio. They allow you to switch settings easily to match your circumstances or environment. An icon  1 showing the number of the profile selected, appears on the status line. Up to ten pre-defined user profiles may be configured for your radio. Example user profiles could be *Normal*, **Lone Worker** and *Covert*.

Mode key selection

1. Press the **Mode** key 3 times and then rotate the Navi-knob to scroll through the profiles.
2. Press **Select** (or the **PTT** button) to activate the shown user profile.

Menu selection

1. Select **Menu > User Profiles**.
2. Navigate to a profile and press **Select**.

Example user profiles

Typical profiles could include:



Covert Mode operation

Covert Mode turns off all visual alerts. It deactivates the backlight and adjusts the microphone sensitivity to allow Whisper mode. It also reduces the level of the loudspeaker if an earpiece is not being used. If your radio has a vibrator alert enabled then this is deactivated. See **Whisper mode** on page 29.



Lone Worker operation

This user profile activates the Lone Worker function to allow users working alone to indicate that they are safe. See **Lone Worker** on page 95.



Group Focus

This user profile allows you to prevent any individual calls or group calls from any talkgroup other than the selected talkgroup from being connected to your radio.

Any calls made to a radio which has Group Focus selected are not recorded as Missed Calls.



Do Not Disturb

This user profile allows you to focus on an important task. It assumes you do not want to be distracted by a call or alert on your radio. The profile sets your radio so that no incoming calls are allowed except calls from the current talkgroup (Group Focus above). Covert Mode operation is active. Audible alerts are disabled. If this profile is selected you cannot select Transmit Inhibit (see **Transmit Inhibit** on page 75

Man Down

Man Down is a licensed customisable feature which uses motion sensors to detect motion in three dimensions. When your radio is powered on it stores its current angle of inclination (orientation). If it moves more than a customised angle from the original inclination or is stationary for more than a customised length of time, the radio sounds an alarm and displays a 'Man Down Alarm' message. In other words the radio can detect conditions indicating that you have become incapacitated. If you do not respond to the alert within a customised time period, your radio initiates a Man Down Emergency and takes action depending on its customisation.

Although Man Down is intended to increase the chances of incapacitated users being detected, you should not regard it as a substitute for compliance with appropriate risk assessment and other safety procedures and practices. Do not entrust your safety to the Man Down Alarm.

Test the Man Down Alert and Alarm regularly to ensure they are functioning correctly.

Once started the Man Down Alarm sounds either until you switch it off or until the battery runs down. Ensure that the battery is charged regularly and check that it has as much charge as possible before activating Man Down.

Man Down is disabled if the radio is placed in a car kit or charger.

The Man Down feature may be customised so that you do not have access to the following:

- the soft key On/Off toggle or a user profile to switch the feature on and off;
- the Man Down screen to select the sensor or combination of sensors used as described below.

To toggle Man Down on/off:

1. Activate Man Down using one of the following methods:
 - Press a customised soft key to toggle Man Down on. The sensors activated are those set in **Man Down options** on the facing page.
 - Select a user profile which uses Man Down (see **User profiles** on the previous page). The sensors activated are those customised in the profile.

A message ('Man Down Starting') is displayed and an alert sounds (a succession of beeps).

2. Attach your radio in a comfortable wearing position on your body. When a two second continuous tone finishes the radio's 'normal' wearing position has been recorded. An icon indicates that Man Down is switched on and which sensors are active.

To deactivate Man Down, either select a user profile which does not use Man Down, or press the customised soft key to toggle Man Down off.

Cancelling false alarms

If the active sensors detect a possible 'Man Down' situation the Man Down Alert is sounded and a Man Down Alert message is displayed on the screen. If you are safe (that is, this is a false alarm) you need to switch off the alert, otherwise a genuine Man Down Emergency situation is considered to have occurred and—depending on the customisation of your radio—various automatic actions are initiated. For example, an Emergency Status message may be sent to a pre-defined destination.

To switch off the Man Down Alert (false alarm situation):

- press a designated key (which is different from the soft key used to switch Man Down on and off) or
- move the radio vigorously for a short period of time (if customised).
For example shake the radio up and down or sideways, or tap it, or (if the radio is clipped to your belt) move your hips rapidly from side to side.

After the Man Down Alert is switched off your radio may be customised to start recording and storing the current position and/or angle to use as the new 'steady' position.

Man Down options

1. Press **Menu** then select **Applications > Man Down**.
2. Select the Man Down sensors to use:  **Motion & Tilt** sensors,  **Motion Sensor** only, or  **Tilt Only** sensor.

If you enable Man Down from a User Profile, the Man Down Settings screen updates to reflect the sensors defined as active in the Profile.

Lone Worker

If you are working alone you can use the **Lone Worker** feature to let your dispatcher know that you are safe.

When Lone Worker is enabled your radio periodically sounds an alert which you must acknowledge—usually by pressing a pre-programmed key—otherwise the radio can be programmed to send either, or a combination of, emergency status, emergency call, and GPS position.

To enable Lone Worker, scroll to a user profile which has **Lone Worker** enabled, then press the **Select** context key. See **User profiles** on page 93.

To disable Lone Worker mode, repeat the process and choose a different user profile.

WAP

Your radio may be configured to browse WAP pages. The browser options are customised using Radio Manager, and some WAP pages may be stored locally on the radio's microSD card.

Starting the WAP browser

To open activate the WAP browser:

- select the **WAP** option from the **Applications** menu OR
- press a programmed soft key [customisable] OR
- open a WAP URL contained within a received SDS message (or your radio may be customised to open the WAP URL automatically). **Open a URL in a message** on page 69

Using WAP

Exiting the browser

Exit at any time by pressing **Back** or the Cancel/Home key (if customised).

Navigation

Press the Left navigation key to display the previous screen/page and the Right navigation key to display the next screen/page.

Entering text

If customised, your radio supports the entering of text to specify a URL and entering of data into a form, and so on. See **Text entry** on page 64.

Saving check box or radio button selections

Sometimes you may need to select an option which has a check box or radio button. When setting an option that uses a check box or radio button, toggle the left context key to select the appropriate option (radio button or check box). To save the selection either scroll to the bottom of the screen and highlight the Save button or press the Left context key (either a tick icon or labelled Save depending on customisation).

Browser menu

Home Page

Select to activate the WAP browser and display the browser's homepage contents. If customised, you can change the Home Page (**Settings > Settings > Homepage**).

Browse

Select to enter a URL to start browsing the internet for the site matching your URL.

You do not have to enter the URL specific input words (http://), they are already entered in the URL box.

Resume Browsing

Select after browsing has been suspended or when you have exited from the browser. The browser displays the last page viewed.

Bookmarks

Select to view all the available bookmarks, some of which may be collated into bookmark folders. If customised, you can create, edit and delete bookmarks and bookmark folders, and organise the bookmarks into different folders. If there are no saved bookmarks, the browser displays the bookmarks page and a warning message.

Settings

Select to view and edit your browser options. You can set the URL of the home page, enable/disable downloading of image files, change the scrolling method and the network connection timeout. There are also options to change security settings.

Help

Select when the browser is active to view any customisable help stored on your radio.

Navigation menu

Press **Homepage > Menu** from the WAP browser screen to access the Navigate options:

Home

Returns to the Home page on the WAP browser.

Open Page

Displays the 'Go to URL' screen (if customised).

Mark Page

Only visible if the radio is customised to allow the creation and/or editing of bookmarks. Creates a bookmark for future reference so that the web page may be downloaded quickly.

Forward/Back

Use these options to move to the next or previous page in the History (if more than one page is stored in History).

Reload

Reloads the current page.

Settings

Selecting **Settings** from the Browser menu provides access to the Advanced settings.

Advanced Settings

Homepage

Select this option to set the Home page. You can enter a new Home page URL and set it as the current and default home page.

Downloads

You can disable or enable the downloading of images, background sounds and objects when downloading information from a website. Disable this option to download the text content of an item quickly (a box containing a cross is displayed where the image would have been). If the downloading of images is enabled the boxes may be shown with a temporary display of a paper clip while the image is downloaded. Scroll to the **Save** option and press **Pick** to save the setting.

Scroll Mode

You can change the Scroll Mode to be Block or Smooth so that when scrolling through text, the display will either jump from one block of text to the next, or scroll smoothly. The scroll speed may also be set to Fast, Medium or Slow.

Key Press Timeout

This option allows you to set the Key Press Timeout to one of Fast, Medium, Slow or Off.

Connection Timeout

This options allows you to set the timer that specifies how long the browser will wait before cancelling idle network requests.

Resend Data Prompt

This option allows you to set (on/off) whether the browser confirms whether to resend data to the radio. This could be used for forms which are not stored locally in the browser cache and must be re-requested from the server.

Security settings

Secure Prompt

Select this option to set (on/off) whether the radio displays a warning message when it is changing from a secure connection to a non-secure connection and vice versa.

Current Certificate

If this option is selected, information about the digital certificate associated with the server which delivered the current document is displayed.

CA certificates

A certificate is a digital ID that is issued by a trusted third party known as a certificate authority (CA). The radio uses CA certificates to authenticate web sites which send information to the radio. To view information on a CA, select it and press View. You can choose which CAs are used by the radio by selecting on or off.

Send Referrer

If this option is used to set whether the browser sends the HTTP Referrer header as part of the HTTP requests.

Authentication

This option is used to set (on/off) whether the browser caches HTTP authentication credentials.

Certificate Info

If this option is selected, information about the root digital certificates installed in the browser is displayed.

Clear

Select this option to clear any or all of History, Cache or Cookies.

Restart Browser

Select this option to restart your browser.

About

Select this option to view information about the browser.

History menu

The History page displays a list of up to nine of the most recently viewed Browser pages. The currently viewed page is highlighted. To revisit a page listed in the History, select it and then press the Left context key.

If more than nine pages have been viewed, the list of all pages in the History is stored and may be accessed by selecting the 'More...' option. Press the Left context key, or the star (*) or hash (#) key, to open the 'More' page(s).

Exit history

Select this option to exit History and resume browsing at the page which was selected when the History Menu was chosen.

Show URL

Select this option to display the currently selected URL.

Delete

Select this option to delete the history.

Using bookmarks

A bookmark consists an internet address, the book mark title, and access point (and a user name and password if required by the web page). Bookmarks can be organised into folders to make it easier for you to find your favourite bookmarks or those of similar topics.

Any saved bookmarks and bookmark folders are listed and can be opened by either pressing the keypad key corresponding to the number of the bookmark or folder, or by selecting it and pressing **Go**.

New bookmarks and folders

If you have no saved bookmarks or folders, the screen displays the message '**No saved bookmarks**'. You can create up to 100 bookmarks and up to 10 folders (a single folder can contain 100 bookmarks).

Press **Bookmarks > Menu** to create your bookmarks.

New Bookmark

Select this option to create a new bookmark. Press the Edit key and enter the title of the bookmark, URL and select the folder. Select Save when done.

If you want to create a new folder for this bookmark, select the Bookmark option and press **Select**. Select the **New Folder** option and enter the details of the new folder.

New Folder

Select this option to create a new folder. Enter the name of the folder and press Save. The folder appears on the Bookmark menu and as an selectable option when creating a new bookmark.

Bookmark and folder options

You can perform the following functions on a selected bookmark or folder:

- **Details** - shows the details of the selected bookmark or folder.
- **Delete** - allows you to delete the current bookmark or folder.

- **New Bookmark** - creates a new bookmark.
- **New Folder** - creates a new bookmark folder within the list of bookmarks and folders.
- **Move** - Move the bookmark or folder within the list of folders and bookmarks. Select the bookmark or folder, then enter the number corresponding to the position in the numbered list where you want the bookmark or folder.
- **Delete All** - deletes all bookmarks and/or folders that are displayed in the same list as the selected folder.
- **Hotkeys** - allows you to create Hotkeys, but if any soft keys have been customised on the radio which are not related to the WAP browser the Hotkeys function will not function.

Additionally, the following options are available for bookmarks:

Move to folder -allows you to move the bookmark into a folder, and name the folder.

Set as Homepage - allows you to set the page as your Home page in the browser. This page is displayed when you select the 'Go to Homepage' card.

Call handling

Outgoing

While the browser is active it is possible to make a group call to the attached talkgroup by pressing the PTT. If a talkgroup has not been attached, the user may select a talkgroup (see section on Group Calls). During an outgoing call the browser remains active but you will only be able to view the current page and pages which have already been viewed.

When a call is in progress and the browser page is displayed, pressing and holding the Right navigation key allows you to view the call information box. If the call information box is displayed while the call continues, the browser page may again be displayed by pressing and holding the Left navigation key, or simply pressing either of the Left and Right navigation keys.

It is not possible to make an individual voice call while the browser is active. In order to do this, close the browser by pressing and holding the Cancel/Home key, if customised. When the call is set up and is ongoing it is possible to return to the browser either by selecting a card which allows this (Resume Browsing) and pressing the Down navigation key or by using a soft key (if customised). When the browser has been re-activated and the call is ongoing it is possible to switch between displaying the call information box and the browser using the Left and Right navigation keys as described above.

During an outgoing individual call the browser remains active but the user is only able to view the current page and pages that have already been viewed.

If the user makes a Alarm Call while the browser is active, the browser will automatically be closed and the radio will display the top level screen in Call Mode.

Incoming

When an individual call is received while the browser is active, the call information box is visible on top of the browser and you can answer the call. If an Alarm Call is received the browser closes and

the radio displays the Home screen, allowing you to respond to the call. You can still make a group call attached to a talkgroup but not a telephone type call whilst the browser is open.

SDS messages

If an incoming SDS message is received while the browser is active and the message is marked for immediate display then the browser will close and the SDS message is displayed. If the received SDS message is not marked for immediate display the browser will remain active and a warning triangle appears and the LED will flash. It is not possible to send an SDS message while the browser is active.

Mode change (TMO, DMO AND GMO)

If the radio is switched to Direct Mode Operation (DMO) while the browser is active, the browser remains active and you may view any stored pages. A warning message is displayed because the browser is off line.

Keypad lock

If a keypad lock soft key has been customised so that the keypad lock may be selected by pressing and holding the soft key, the browser will close and the radio will display the top level screen.

Transmit Inhibit

If the radio is operating in Transmit Inhibit mode, you can still view any pages in the browser that have been stored locally but it is not possible to browse pages online. If an attempt is made to browse pages online, the browser active icon flashes and a warning message appears.

Location Services

Your radio may be customised and enabled for location services, such as GPS or other regional Global Navigation Satellite Systems (GNSS), that allows the radio to determine your location (longitude, latitude and altitude) and provides both timed- and distance-based reporting.

The generic location services function on the radio is called 'GPS' and it provides support for multiple regional GNSS including BeiDou2.

The behaviour of the GNSS function is highly customisable, both by customisation of the radio and over the air from a control room application. Your radio may also be customised to send position data automatically alongside TETRA Alarm Calls or Status messages. The destination to which any reports are sent may be changed over the air. If your radio accepts a change of destination command it sounds a customisable tone and sends you an SDS message to inform you.

If customised, you can enable/disable the GNSS function, see **Reporting options** on the next page.

For the best performance, your radio needs an uninterrupted view of the sky.

Position

To locate your position

1. Select **Menu > GPS > Position > Locate**.

While the position is being calculated the  icon flashes.

Position information

When the position has been determined the following information is displayed:

- **Latitude and Longitude** values.
- **Fix** indicates how accurate the reading is:
 - 2D** indicates that less than four satellites were used to determine the position
 - 3D** indicates that at least four satellites were used.The number in brackets indicates how many satellites were used.
- **Age** shows how long ago the position was first displayed; to refresh the reading press **Locate** again.
- **GPS/BeiDou2** shows the number of satellites used in the selected system. Note that the name of the selected GNSS is customisable.

Direction

To read the direction in which your radio is travelling

1. Select **Menu >GPS > Direction**.

The Direction screen gives information about the current direction and speed of travel. If the radio is stationary no information is displayed. However if the radio becomes stationary after a period of movement the direction information is displayed for five seconds to give you time to view it.

- **Direction** is reported in degrees from North.
- **Speed** is reported in either km/h or miles/h depending on the customisation.

Reporting options

To control reporting from your radio

1. Press **Menu > GPS > GPS Report**.
2. Select one of the following options:
 - **Never Send** – reporting is disabled regardless of any instructions sent over the air. The  warning icon is displayed on the top line of the screen as a reminder that reporting has been explicitly disabled.
 - **Always Send** – reporting is enabled regardless of any instructions sent over the air.
 - **No Override** – your radio will respond to instructions sent over the air. Reports are sent if requested and is switched off if requested.

GNSS selection

The radio may be customised to support a number of satellite systems such as GPS and BeiDou2.

To change your GNSS selection:

When the radio has rebooted, check your satellite connections using the GPS **Locate** function (**Menu >GPS > Position > Locate**) to view the type and number of satellites available in the selected system.

Bluetooth®

If your radio is Bluetooth enabled it can connect wirelessly to audio devices such as a headset, or to one of many commercially available data devices over a distance of up to 10 metres.

In order to use Bluetooth wireless technology your radio must first be 'paired' with a device. Pairing is the process which links two Bluetooth devices so that they may communicate. Your radio may be paired with up to ten different devices at any one time. A device only needs to be paired with the Sepura radio the first time it (the device) is used. The pairing is remembered until the device is deleted from the list of paired devices.



Warning! When you re-customise or update the software on your radio the device pairings are lost. This means you have to re-pair the radio with other Bluetooth devices before using the radio again.



Caution! If you pair your radio in a public place, beware of eavesdropping by unwelcome Bluetooth users.



NOTE: The Bluetooth Hands Free Profile is not supported.



Tip! If Bluetooth is not working, your radio may not be fitted with a Bluetooth module and/or Bluetooth may not be a licensed feature on your radio.

Bluetooth® on/off

To toggle Bluetooth on/off

Use one of the following:

- Press a customised soft key.
- Press **Menu** then select **Options > Bluetooth > ON/OFF**.

When Bluetooth is switched on but no devices are connected the  Bluetooth icon is displayed. The radio's Bluetooth name, which is visible on data devices when they attempt to 'pair' with your radio, is shown on the screen.

Audio devices

You can search for and pair an audio device with your radio or view which devices have already been paired from the Devices screen. Once paired it is possible to connect to or disconnect from a Bluetooth® device while a call is in progress either using the Bluetooth® menu screens or a soft key

(disconnection only) if customised. It is also possible to connect to a headset by pressing the button on the headset.



Tip! Before attempting to pair, check that the audio device is powered on, is set to the discoverable (visible) state and is close to your radio before attempting a new search. If several devices are available it is advisable to power off any which are not required and set only the required device into the discoverable (visible) state.

Connect with audio devices:

1. Press **Menu** then select **Options > Bluetooth > Devices**.
2. Select **Search**. (Search is prevented if the Bluetooth® is switched off or if the maximum number of devices (ten) have already been paired.)
3. If you are prompted to enter an Access Code, enter it as described in **PIN entry** on page 110. If you enter an incorrect Access Code an error message and a large cross are displayed and it will not be possible to pair any devices with the radio. Correct Access Codes are valid until the radio is powered off.

During searching a 'Searching' message is displayed and any data devices found are listed. The search stops when all available data devices have been found up to the maximum of ten, and a 'Search Complete' message is displayed. If no devices are found a warning message 'No Devices Found' is displayed. To stop the search early and keep any devices found, press **Stop**. (Press **Cancel** to abandon searching **and delete any devices found**.)

Tip! If a device is not found, check that the data device is powered on, is set to the discoverable (visible) state and is close enough to your Sepura radio before attempting a new search.

Any audio devices found are listed on the screen as they are found. Audio devices which may be worn on the body show the  headset icon and non-wearable audio devices such as a car kit or similar device show the  car icon. The most recently found device is listed at the top and is highlighted in blue.

4. Select the required device in the list and then press **Pair**. The message 'Pairing' appears.
5. If you are prompted to enter a pass code, enter the code generated by the device into the Passcode box on your radio using the keypad. If an incorrect passcode is entered an error message and a large cross are displayed.
6. If you are prompted to enter a passcode, enter the code generated by the device into the Passcode box on your radio using the **Select/Send** key and the Navi-knob. If an incorrect passcode is entered an error message and a large cross are displayed.

When a device has been paired the search results are lost and the radio displays the list of existing paired devices. To pair another audio device you must perform a new search.

7. On your radio press **Connect** to connect with the device. (You can also Modify the device list, see **Modify connected devices** on page 109.



NOTE: When connected the  Bluetooth® Connected icon is shown beside the name of the device and the audio is routed to the device. You can typically use the Talk button on the paired headset to connect or disconnect the headset, answer an incoming duplex call and switch the headset on or off. On headsets that support the AT+CTKST command you can use the PTT on the headset to answer and participate in half-duplex calls.

Tip! With some Bluetooth® headsets, after you connect the headset to a radio you need to press the headset button to route the audio to the headset. This may also be necessary if you move out of the Bluetooth® range while wearing a Bluetooth® headset and then you move back within range. Note that with these headsets the radio display may indicate that the headset is connected whether or not the audio is routed to the headset.

Tip! If you are choosing a Bluetooth® headset it is worth considering that some Bluetooth® headsets have a single combined button for Power On and Accept which only requires one press to turn on the headset and route the audio.

To disconnect the radio and the data device at any time press **Disconn**. It may also be possible to disconnect a device by using a soft key (if one has been customised). When a device has been disconnected it may be reconnected by selecting **Connect**.

Data devices

You can pair your radio with data devices such as a laptop or PDA. When you pair to a data device it 'discovers' your radio.

To pair with an incoming data device:

1. Press **Menu** then select **Options > Bluetooth > Devices**.
2. Select **Discoverable**.

If your radio has been customised not to allow any incoming pairing operations 'Cannot Add Device' is displayed on the Devices screen.

3. If you are prompted to enter an Access Code, enter it as described in **PIN entry** on page 110. If you enter an incorrect Access Code an error message and a large cross are displayed and it will not be possible to pair any devices with the radio.

4. Press **Select** to make your radio discoverable by any Bluetooth® device in the vicinity. A 'Radio Visible' warning displays to inform you that your radio can be discovered and a random passcode is generated and displayed. If customised the blue LED will flash on and off every second as an additional warning.
5. On the data device, search for Bluetooth® device in the vicinity and pair it with your radio using the generated passcode. Refer to the User Guide of the device for details of how to do this. Input and accept the generated passcode; this passcode is not required after pairing.
6. The Terminal Visible Passcode appears if a random passcode is configured or the message "Terminal Visible" appears if a fixed passcode is configured.
7. The method of pairing the devices will depend on the Bluetooth® capability of the connecting device. If the connecting device support SSP, the device may automatically pair with the radio. Alternatively the device generates a random 6 digit PIN that is matched to a generated code on the radio. Press **OK** to confirm the match and pair the devices. If the connecting device does not support SSP, the device will prompt to enter a passcode manually. Enter the random passcode shown by the radio onto the device or a fixed passcode already given.
8. When the pairing is successful, the radio will display confirmation that the pairing is successful.
9. On your radio press **Accept** to confirm the request and to connect with the device.

A message is displayed to confirm the pairing and the device is listed in the list of paired devices. (You can also Modify the device list, see **Modify connected devices** on the facing page.

Tip! If customised to do so, your radio will automatically connect to a 'trusted' device—the data device that was most recently connected to the radio—whenever requested to do so unless you explicitly disconnected it by pressing **Disconn**. In this case to reconnect the radio and the data device press **Connect**.



To connect with an outgoing data device:

You can search for—and then pair—your radio with data devices you discover.

1. Press **Menu** then select **Options > Bluetooth > Devices**.
2. Select **Search**. Search is prevented if the Bluetooth® is switched off or if the maximum number of devices (ten) have already been paired.
3. If you are prompted to enter an Access Code, enter it as described in **PIN entry** on page 110. If you enter an incorrect Access Code an error message and a large cross are displayed and it will not be possible to pair any devices with the radio. Correct Access Codes are valid until the radio is switched off.

During searching a 'Searching' message is displayed and any data devices found are listed. The search stops when all available data devices have been found up to the maximum of ten, and a 'Search Complete' message is displayed. If no devices are found a warning message 'No Devices Found' is displayed. To stop the search early and keep any devices found, press **Stop**. Press **Cancel** to abandon searching and delete any devices found.

Tip! If a device is not found, check that the data device is switched on, is set to the discoverable (visible) state and is close enough to your Sepura radio before attempting a new search.

Any PCs (laptop, desktop, or server) found show a  PC icon and hand-held PDAs show a  PDA icon. No icon is shown alongside the name of a device which has a different Class of Bluetooth Device from a PC or PDA.

4. Select the required device in the list and then press **Pair**. The message 'Pairing' appears.
5. When a device has been paired the search results are lost and the radio displays the list of existing paired devices. To pair another data device you must perform a new search.

If a radio is paired with a PC running Windows and the pairing is subsequently deleted and the radio given a new Bluetooth® name before pairing again, it is possible that the PC will remember the original Bluetooth® name and will not recognise the new Bluetooth® name.

6. On your radio press **Connect** to connect with the device. You can also Modify the device list, see **Modify connected devices** below.

To disconnect the radio and the data device at any time press **Disconn**. It may also be possible to disconnect a device by using a soft key (if one has been customised).

When a device has been disconnected it may be reconnected by selecting **Connect**.

Modify connected devices

Any Bluetooth® devices that have been paired with the radio are listed on the Devices screen. You can edit the name of these devices or delete them.

1. Press **Menu** then select **Options > Bluetooth > Devices**.
2. Select the device name and press **Modify**.

To edit a device name:

Select **Edit** to rename different devices of the same type to make it easier to distinguish between them.

To delete a device:

Select **Delete Device** to delete the device from the list of paired devices.

Security

Sometimes when you are working, you may need to secure your radio from unauthorised use. The easiest way to secure your radio is to lock the keypad when your radio is not in use. Your radio may be customised with other security features such as PIN entry and a remote user network log on (to authenticate network users).

PIN entry

You will need to enter the radio's 4 digit PIN at power on. Your radio may be customised to allow you to change your PIN (see **Change PIN** below).

If you incorrectly enter the PIN 3 times, the radio will lock. You will then need the 8 digit Master Reset PIN (or PUK) to unlock the radio, see **Unlocking the radio after incorrect PIN entry** below.

To unlock your radio:

1. Enter your PIN.
2. Press **OK**.

If you make a mistake you can use the **Left** navigation key to delete the last digit entered.

Change PIN

You can change your radio's PIN required at power on.

1. Select **Menu > Options > Settings > Change PIN**.
2. Enter your current PIN, then press **OK**.
3. At the prompt 'Change PIN?' press **OK**.
4. Enter your new PIN twice to confirm.

A large tick displays to confirm that the PIN is changed.

Unlocking the radio after incorrect PIN entry

If you enter the PIN incorrectly 3 times, the radio will become locked. To unlock your radio you will need the radio's Master Reset PIN (or PUK) that consists of 8 digits.

The default PIN is 00000000 but this can be changed by your Communications or Security Manager.

To unlock the radio:

1. Enter your 8 digit Master Reset PIN.
2. Press **Confirm** or the **Select/Send** key.

If you enter the Master Rest PIN incorrectly, you need to wait at least 5 seconds before attempting to enter the PIN again.

If the Master Reset PIN is successful, the radio reverts back to the last known PIN.

If you radio is customised to allow the PIN to be changed, select **Options > Settings > PIN Change**.

End-to-End Encryption

If your radio shows the  Secure Comms icon when it is idle, the selected talkgroup is customised for **End-to-End Encryption (E2EE)**. In other words, calls you make by pressing PTT are end-to-end encrypted.

It is not possible to accidentally make a non end-to-end encrypted call. Every talkgroup or individual subscriber that can be exempt from End-to-End Encryption must be explicitly customised into the radio.

End-to-End Encryption is designed to provide maximum security for voice and SDS communications, whether operating in Direct Mode or Trunked Mode, irrespective of the security level provided by the network. Depending on customisation, the radio may change the End-to-End Encryption status when the selected network is changed. It may also provide a selection of talkgroups on other networks. If a talkgroup is selected that does not belong to the current network, your radio will change network accordingly.

A radio that supports End-to-End Encryption may nevertheless be required to make calls that are not end-to-end encrypted. For example, calls to certain talkgroups and individual subscribers may be customised to be exempt from End-to-End Encryption. All telephone calls are also not end-to-end encrypted.

When dialling, a separate  Secure Comms icon is displayed in the dial box if the call or SDS will be End-to-End encrypted. During voice calls only (not SDS calls) your radio may allow you to toggle End-to-End Encryption on/off with a soft key.

When you are in a voice call, the Secure Comms icon indicates whether End-to-End Encryption is operational. When the radio participates in a call that is not end-to-end encrypted, a periodic non intrusive audible alert is generated (if customised).

When you receive an SDS (text) message or picture messages, if you see the Secure Comms icon in the message details that the message was end-to-end encrypted.

If the message 'Security Check Fail' is displayed while making or receiving calls, it indicates that the radio has not been customised properly. In such cases, please contact technical support in your organisation.

Updating E2EE keys

End-to-End Encryption keys are automatically updated when the radio registers on the network when it powers on, and whenever the Key Management Centre (KMC) on the network broadcasts them.

If E2EE traffic keys become outdated—which can happen in poor network coverage conditions—you can manually update them as described here.

Manual key update is not supported on radios which rely on a Smartcard for E2EE.

During a manual update any active ongoing non-emergency call or ambience listening calls are cleared. (Any active emergency calls are maintained.)

Manual update requires good network conditions.

To manually update E2EE keys

Your radio must be in TMO mode to update E2EE keys.

Either press a suitably customised soft key or use the following procedure:

1. Press **Menu** then select **Security > Crypto Settings**.
2. Scroll to **New Key** and press **Send**.

When the key update is in progress the  **Key agreement** status icon appears.

Asset management

Handsets, consoles, radios and accessories are assets that need to be effectively managed throughout their life cycle. In some organisations it is a requirement to track assets and this can be done by labelling them.

Asset management refers to the periodic maintenance of your radios. Maintenance includes software upgrades and reprogramming of the radio to ensure that it continues to meet your requirements.

During programming the radio uploads information, such as the State of Health of the battery which can also assist with auditing and end-of-life strategies.

Labelling

The simplest form of asset management is to attach labels to your radios and batteries. Self adhesive labels (those with an adhesive backing) are recommended as they are easy to apply and commercially available, such as 3M™ Thermal Transfer Polyester label material 7815.

Your radio and Sepura battery provide an area for attaching an asset label. Placing the label here will prevent it interfering with the way the product is used.

Do not use solvent based adhesives. Always check the adhesive used with the self-adhesives label.

Do not engrave any part of the radio. Engraving the radio's casing may affect the compliance ratings and may invalidate the product warranty.

Do not use paint, correction fluid or other forms of liquid or aerosol to write or mark the radio or an accessory. Chemicals may affect the radio's casing and invalidate the compliance ratings and product warranty.

Place a label on the back of the radio in the Radio user label area above the carrying aid attachment point as shown.

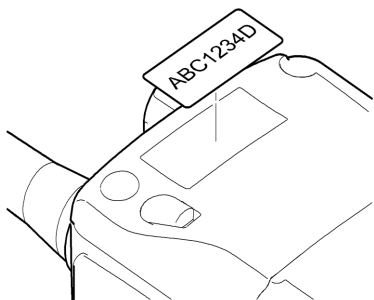

Alternatively, a label can be placed on the Card Compartment door recess, but it must not interfere with the fitting of the battery or the opening/closing of the card compartment.

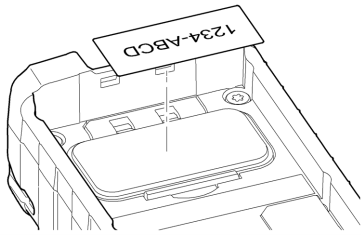

Place a label on to the Battery user label area.

Do not place the label over the battery contacts or the warning label at the base of the battery.

Customising your radio

Your radio has a large number of parameters that can be customised using the programming software tool, Radio Manager 2. These parameters are grouped into a series of templates that can be easily modified to suit the end user's preferences. A complete set of parameters for your radio is called a **customisation**.

Your radio must be powered on and have sufficient battery charge for the duration of the customisation process.

Do not attempt to program this radio when located within a hazardous environment.

To program your radio

A USB programming cable must be used to connect the radio to the computer running the programming software. The cable is designed for programming intrinsically safe radios and meets ICECx/ATEX intrinsically safe guidelines to protect against transient or faults damaging the radio.

1. Connect the programming cable to the computer.
2. Remove the RuSC connector cover using the 3 mm A/F Hexagon Driver.
3. Connect the programming cable to the RuSC connector.
4. Customise your radio.
5. When programming is complete disconnect the cable from the radio.
6. Replace the RuSC cover or fit an accessory to the radio.

Revert radio settings to customisation settings

Users have the ability to add personal data to the radio, such as adding contacts to the phonebook, changing the talkgroups and sending and receiving SDS/Status messages. Such changes may be undesirable on fleet radios that have been specifically customised for fleet users—where radios are not personal possessions. Using the **Revert All Changes** option, the radio settings can be reset back to the last customisation settings.

There is also a **Revert Non-Personal Changes** option that allows users to reset the radio settings back to the last customisation, but keep their personal changes to the phonebook, talkgroups and messages.

To revert the radio settings:

1. Select **Menu>Options>Settings**, then select the **Revert User Changes** option.
2. Select the option you require. Press the Select key.
3. Confirm the request to revert the radio settings to the last customisation. Press the Select key.

On completion of the revert process, the radio will reboot.

Accessories

There are various accessories available for your radio from fastening clips for attaching the radio to clothing, to headsets and microphones that provide hands-free operation. Only use Sepura approved accessories with your radio. Sepura products have been tested to meet strict guidelines for personal safety and operational conditions. The use of non-approved accessories may damage the product, will result in the non-compliance with regulatory requirements, compromise the product safety ratings, and will invalidate the product warranty.

Some accessories may not work in close proximity of a TETRA radio. When using USB and BT accessories, it is recommended that they are worn on the opposite side of the body to the radio. It is the responsibility of the service provider to ensure that appropriate EMC testing has been conducted on accessories.

Risk to Personal Safety. A Sepura approved intrinsically safe ATEX / IECEx accessory must be used with this radio.

When your radio powers on and when you attach an accessory during operation, your radio performs an authenticity check on any attached accessories including the battery. If the accessory is not authenticated, a message appears and the accessory should be removed.

When your radio powers on it performs a authenticity check on any attached accessories including the battery. It also runs this check when you attach an accessory at any time during operation. If the accessory is not authenticated, a message appears and your radio will power down. .

Your radio has a Rugged Side Connector (RuSC) that is used for attaching all audio accessories. It is also used for programming the radio.

When using an RSM with antenna, it should be held a minimum distance of 25 mm from the mouth.

NEVER fit or remove any accessory when operating in a hazardous environment. However the RSM and large button PTT accessories provide connectivity to allow intrinsically safe approved NEXUS terminated audio accessories that can be safely fitted and removed (hot swap) whilst operating in dust and gas environments.

You do not need to power down the radio before attaching or removing an accessory.

Always read the instructions supplied with the accessory for operating instructions and safety information.

Accessory profiles

Your radio may be customised with up to 15 accessory profiles. Selecting a profile that matches the attached accessory will provide optimum audio quality speech and volume when the accessory is in use. It is not necessary to select a profile, however, if a profile is not selected or the accessory is not supported, the audio may not be of optimal quality.

The profile is only applied when the accessory is in use.

Selecting a profile when attaching an accessory

When you attach an accessory, the radio will attempt to match the accessory to a profile. If there is only one matching profile, the radio will automatically select that profile and there is no user action required.

If the radio is customised to provide several profiles for an accessory, when the accessory is attached the **Accessory Profile** screen appears listing all available profiles. The highlighted profile is the current or default profile for the accessory. To select a profile, highlight the profile and then press the **Select** key.

If you change to another accessory whilst operating the radio, the **Accessory Profile** screen appears, allowing you to select a new profile or accept the default profile for that accessory (highlighted). To select the profile, press the **Select** key.

If you attach a second accessory, such as adding an accessory to an RSM, the **Accessory Profile** screen appears and you can select a new profile.

A soft key on your radio may be customised to open the **Accessory Profile** screen at any time during operation, allowing you to change the profile to suit your conditions, for example you may want to select a profile that has a louder volume when working in a noisy environment.

Detecting an accessory at power on

If an accessory is detected when the radio is powered on, and it is the same accessory that was attached at power off, the radio will continue to operate using the selected profile.

If an accessory is removed and then an accessory of the same type is attached before power on, that has a different accessory profile, you must remove the accessory and then re-attach it, or press a customised soft key to open the **Accessory Profile** screen. You can then select a profile for the accessory.

Belt clip

The belt clip is used to attach your radio to clothing or to a belt. The clip is fitted to the carrying aid attachment recess on the back of your radio.

Damage to product. Always remove the battery before fitting or removing the clip.

Fit the belt clip

1. Remove the battery.
2. Slide the stud into the carrying aid attachment recess.

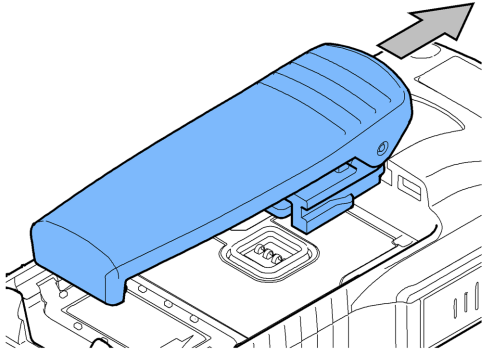

3. Slide until it clicks into place.

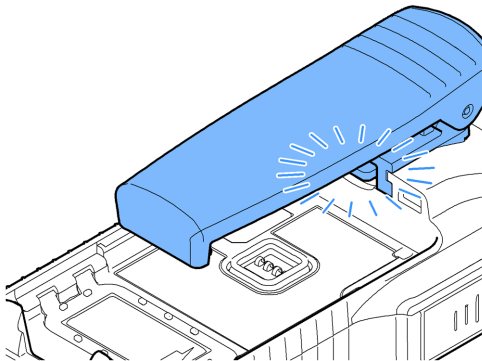

Remove the belt clip

1. Remove the battery.
2. Lift the clip.

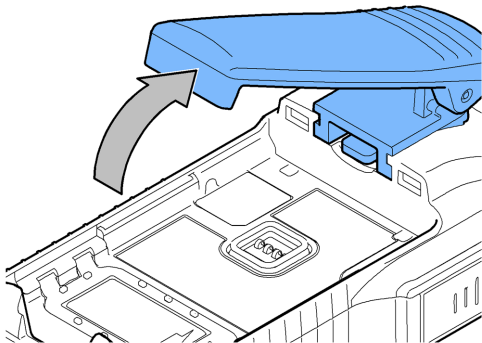

3. Use your thumb to compress the spring and release the clip.

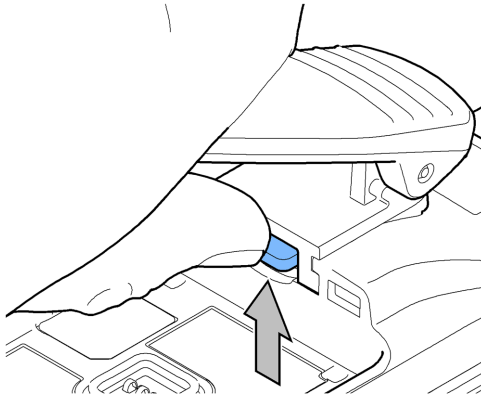

Failure to compress the spring sufficiently to remove the clip, will result in damage to your radio or the clip.

4. Slide the clip out of the carrying aid attachment recess.

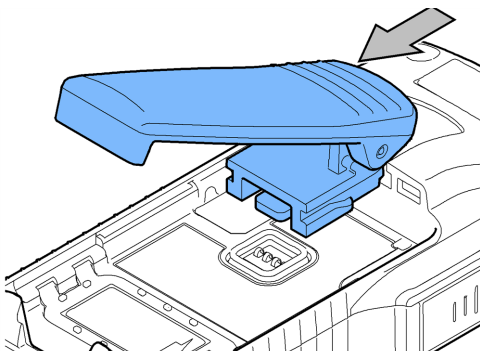

Klick fast stud

Fitted direct to the radio, the Klick fast stud allows quick, easy docking and locking of the radio into any of seven positions used by the patented ratchet system. The available dock kit provides attachments for various types of belts (clothing) and locker or car dash board mountings.

The radio is first inserted into the dock. It can then be angled as necessary. To remove the radio from the dock, it must first be inverted and then it can be removed from the dock.

Damage to product. Always remove the battery before fitting or removing the Klick fast stud.

Fit the stud

1. Remove the battery.
2. Slide the stud into the carrying aid attachment recess.

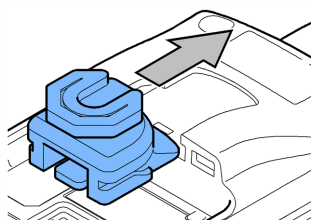

3. Slide until it clicks into place.

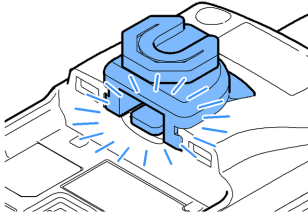

Remove the stud

1. Remove the battery.
2. Lift the spring.

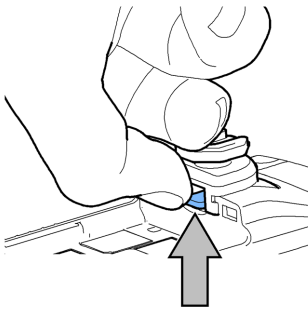

Failure to compress the spring sufficiently to remove the stud, will result in damage to your radio or the stud.

3. Slide the stud out of the carrying aid attachment recess.

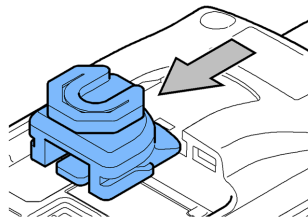

Fit an accessory

Risk to personal safety.

Only fit intrinsically safe ATEX / IEXc accessories to this radio.

NEVER fit or remove any accessory when operating in a hazardous environment.

Tools

3 mm A/F Hexagon driver (supplied with your radio).

To fit an accessory:

1. Use the hexagon-driver to remove the RuSC cover.
2. Insert the hooks on the accessory connector into the slots at the top of the RuSC as shown.

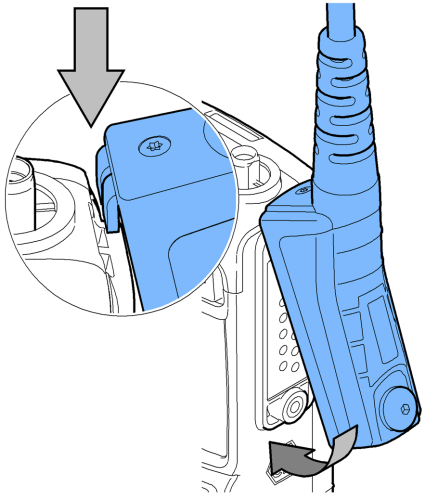

1. Secure using the hexagon-driver

Risk of product damage. Secure to 0.25 Nm (pinch tight). DO NOT over tighten the screw on the accessory connector.

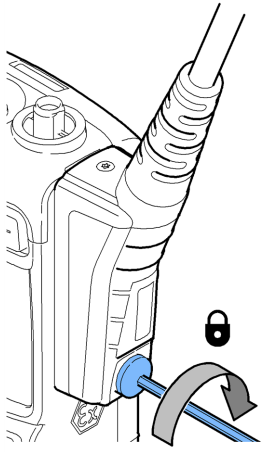

www.linkedin.com/sepurapl



www.facebook.com/sepurapl



[@sepurapl](https://twitter.com/sepurapl)



www.instagram.com/sepurapl



www.youtube.com/sepurapl



Contact Details

Sepura Limited

9000 Cambridge Research Park

Beach Drive, Waterbeach

Cambridge, CB25 9TL

United Kingdom

www.sepura.com